

REMS

www.rems.de



Innovative
manufacturer of
machines and tools
for pipe working

2023

Catalogue



Product information

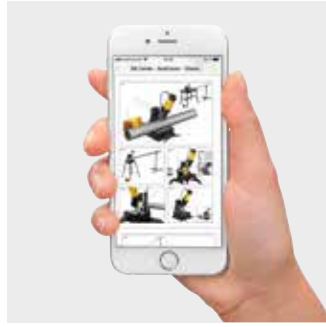

Operating instructions



Parts lists

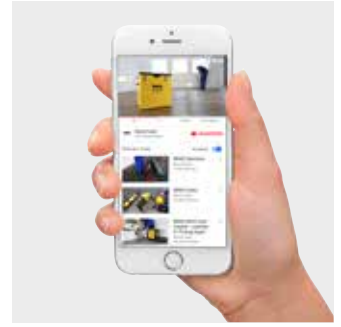

Product films

REMS App – All product information available any time, anywhere – quickly and easily.

On the building site or at your dealer: All operating instructions, parts lists, product information, product films and more can be called upon immediately*. Many other functions are also available to you.



Scan product logo

Are you standing in front of a REMS product? Just scan the product logo and you will get all the product details.



Scan product illustration

You can scan the product illustrations in our offer brochures and get all the details about the product.



Scan QR code

You can scan the REMS QR code and get all the details about the product.



REMS App

Free application software from the Apple App Store or Android App at Google Play.



*Only with an existing data link via network operator or wifi.

Contents















We deliver exclusively on the basis of our general conditions of sale and delivery.

The prices stated in this catalogue are valid for one piece respectively for one set (e.g. dies) or one pack (e.g. saw blades). Prices do not include any value added tax (VAT) and are subject to change without notice. We reserve the right to increase prices. These prices supersede all previous prices.

Drawings, illustrations, dimensions, weights, standards and other data stated in this catalogue are not binding and are subject to alteration. All power data stated to be understood as the rated power input. Subject to alteration. All rights reserved, particularly for translations, reproductions, illustrations, radio transmission, photomechanic reproductions or similar and storage of data in computers, including utilization in extracts.

© Copyright 2023
REMS GmbH & Co KG, Waiblingen.

Sale through specialist dealers.

	Threading Roll Grooving	20
	Sawing	56
	Cutting, Chamfering, Deburring	74
	Assembling	102
	Testing, cleaning, disinfecting, preserving, flushing, filling	112
	Bending	126
	Radial Press Jointing	144
	Axial Press Jointing	240
	Expanding, Extracting	248
	Soldering	260
	Freezing	266
	Pipe and Drain Inspection / Pipe and Drain Cleaning	270
	Plastic Pipe Welding	288
	Diamond Core Drilling Diamond chasing saws	298
	Drying, dehumidifying, aeration and deaeration	324



They are creative and have plenty of practical experience, they continuously find possibilities for improvement of the work of the installation professional: REMS development engineers are innovative and therefore important factors in the success of the company.

REMS – heading technical progress for more than 110 years. Development is never finished.

Since its foundation in 1909 REMS has been developing products for the pipe working, especially for sanitary and heating installers. At first, hand tools and then subsequently machines and electric power tools. The stipulation of the company founder Christian Föll "REMS must be superior" has always been the benchmark for our actions. Today REMS is a leading manufacturer of machines and tools for the pipe working.

REMS development engineers have persuasive, groundbreaking ideas which ease the daily routines of the installations professional. They have all the significant requirements in their focus and use all their comprehensive practical experience. Experts from all areas of industry ensure that every possibility for improvement is integrated in the new development. In this way the perfect tools for the tough demands of the building site are created. The REMS products are highly valued because of their innovative technology as well as their high standards of quality and are being used everywhere in the world. Both trade and user profit in this way.

Again and again REMS is able to maintain its position at the forefront of technical progress as a result of its innovative products. Many valid national and international patents prove this.

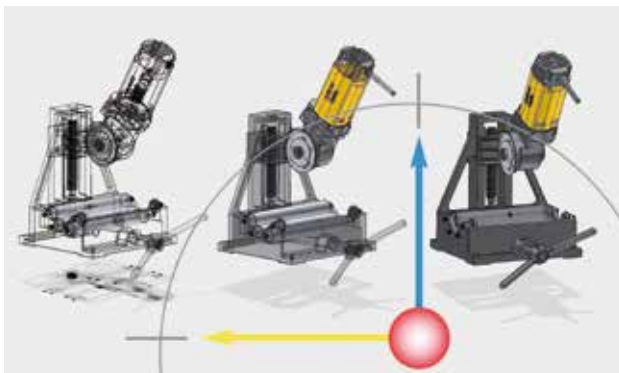

Through the application of modern construction and development techniques, the quality of REMS products has been to the fore from the beginning: Safe use, robust design, simple operation, durability.



New ideas, technical progress and REMS belong together: e.g. REMS Amigo, REMS Tiger, REMS Curvo, REMS Mini-Press 14 V ACC, REMS Multi-Push – products, which have revolutionised the application technology.



Fully automatic 3D measuring machines are a part of the comprehensive quality control system at REMS. The accuracy of measurements at 0.001 mm guarantees the highest precision.

Highly modern production – guarantor for REMS quality products.

Made in Germany. Our own production plant is located in Waiblingen near Stuttgart, in the centre of Germany's high-tech industrial region. There highly modern equipment and facilities are available for research and development, for production and quality control. In addition to this there is a permanent staff of highly-qualified employees, who in part represent the 4th generation of service at REMS. They have the special level of knowledge and experience that is essential for the manufacture of quality products.

Quality means much more to REMS than simply dimensional accuracy and function. It is backed up by a comprehensive quality control system, which begins as early as the assessment of market needs and which is ever present during the product development and manufacture and continues with systematic quality analysis in the market. Furthermore the quality of the production processes is regularly monitored and affirmed by the testing agency that awards the GS safety sign.

All REMS products correspond with safety and accident prevention regulations and fulfil the respective appropriate European standards according to the terms of the EU directives. Additionally, with the exception of a few hand tools which are not safety relevant, all REMS products are checked and approved by independent testing agencies. All REMS products thereby meet an especially high standard with regard to work safety, functional safety and operational safety.



Permanent innovations in processes as well as investments in efficient CNC manufacturing systems engineering ensure that REMS products are amongst the best in the world.



Flexible assembly lines allow adjustment to the requirements of the customer at any time.

REMS is evaluated as having the largest number of training staff in the region. So it is able to maintain its own know-how at a high level.



Tightly defined test intervals during the whole manufacturing process as well as comprehensive function and safety checks after completion of the assembly ensure that no faulty product leaves the plant.



Reliable staff with many years experience are responsible for ensuring that the optimum progression of the hardening process in the material for each component is realised exactly.

Nobody hardens metal better than us. Therefore, we do it ourselves.

Highly durable, safe in application and extremely resilient – a tool can only meet such demands if the components are perfectly hardened.

An important cornerstone for the quality of REMS tools is laid in our own heat treatment shop. The decades of experience has provided important know-how and is the secret of REMS quality tools. The special heat treatment leads to an ideal combination of solidity and robustness and to an especially long durability, as, for example for threading dies, cutter wheels and pressing tongs. The heat treatment process is automatically monitored and permanently recorded by efficient computer technology. This allows a uniformly high product quality.



Our own heat treatment shop – an important aspect of the know-how and the secret of REMS quality tools.



The proven, indestructible REMS quality threading dies. Of robust, especially hardened special steel.



REMS cutter wheels complement the special demands of the various materials. In particular the special hardening process determines the durability of the REMS cutter wheels.



The art of hardening:
It creates extremely resilient components for the highest demands.



REMS
for Professionals

REMS
for Professionals

REMS
for Professionals

5

10

11

12

REMS

Only two from every 45 employees in the logistics industry know that time is money. Speed and absolute reliability are the most important factors for delivery and service.

REMS – for professionals.

Excellent service. On location everywhere.

REMS produces machines and tools for professionals – the demands required are high. REMS fulfils its tasks with competence, responsibility and a first-rate service. This also includes the swift delivery as well as maintenance and repair work. A high degree of flexibility and absolute reliability are the basis for the excellent service.

The whole logistics organisation is oriented towards the needs of our customers. In order to be able deliver promptly REMS keeps more than 10,000 items ready in the central storage facility. All wear and replacement parts are always available. A service that keeps down-times to a minimum.

In the case of a repair the area-wide network of contracted customer service workshops is available for a rapid and professional repair. Highly-qualified and well-trained staff repair and maintain the machines and tools for our customers. After completion of the repair or inspection the products are returned again to the customer by the fastest means.



Speed is a question of logistics. REMS keeps wear and replacement parts in stock in a 14,000 m² storage facility.



The demands at the building site are extreme – wear parts are worn, the need for repairs arises. The REMS customer services department is ready and flexible. There is an extensive service organisation in more than 25 countries.



Service is extremely important for REMS: All demonstration vehicles for the more than 200 REMS specialist advisors are fitted with testing equipment with which the function test and force of pressure measurement for REMS radial presses can be carried out on location everywhere.



Product training in the
REMS training centre:
Become familiar with,
compare, evaluate.

REMS – business partner to the trade. Excellent advice for contented customers.

Only those who receive competent advice when purchasing find the individually best, economic solution for the tasks ahead. For this reason REMS assigns great significance to the product training of its own REMS specialist advisors and also the staff in the specialist stores.

In the REMS training centre, modern and fully-fitted demonstration, training and conference rooms are available in an area of 1,600 m². The practical-oriented training gives the staff of the specialist stores, in an understandable form, a broad basis and high specialist competence for product advice and successful sale. The detailed sales documentation with information relating to all necessary product specifications facilitate a swift product selection and are the basis for the simple and time-saving generation of offers.

This partnership with the specialist store also guarantees the user qualified, comprehensive product advice and excellent service.



REMS training centre in Waiblingen near Stuttgart.



Modern and fully-fitted demonstration rooms:
REMS creates many opportunities for the specialist-store staff to become familiar with the products.

Enrico Müller, Andreas Düssmann, Thomas Kirschner and Rüdiger Lohse, four of more than 200 qualified REMS specialist advisors are flexible and, when needed, swiftly on location for training courses and presentations.



REMS

REMS GmbH & Co KG
Maschinen- und Werkzeugfabrik
Telefon +49 7151 1707-0
Mobiltelefon +49 172 7137108
www.rems.de

REMS
for Professionals

REMS – Market strength through a consistent product and sales philosophy.

REMS' basis for market strength is technically-advanced and high-quality products as well as a product range tightly concentrated on high turnover units and highly competitive prices thanks to the rational, economical in-house production.

At the centre of the sales philosophy the principle has always been that REMS products are sold exclusively via specialist dealers. These are supported by REMS in many ways. REMS specialist advisors equipped with demonstration vehicles carry out product training on location and demonstrate the REMS products at on-site visits, counter demonstrations and at in-house exhibitions. They advise in the selection of the tools and find the most comfortable, reliable and economical solution in each individual situation.



The consistent sales philosophy is designed for long-term results, trust and predictability.



This is how installation professionals become familiar with the product range in practice: The REMS specialist advisors are on the road with demonstration vehicles and demonstrate the machines and tools in real situations, directly on the building site.

The REMS product presentation system – the ideal opportunity for the specialist stores to optimally present the REMS products: touch – compare – select.

REMS

REMS

REMS

REMS

REMS

REMS

REMS

REMS



REMS

REMS



Touch. Compare. Select.

Promoting the mutual sale.

The participation at many national and international trade fairs, the advertising in trade magazines and the direct mail marketing to the user is highly valued by trade outlets as sales-promotion measures.

The attractive REMS product presentation system provides the trade outlet with an optimal presentation of the REMS products: Touch, compare, select. The individual stocking with REMS products is carried out with close cooperation between the REMS specialist advisors and the trade outlet.

The online information system at www.rems.de offers extensive opportunities to find out information about the REMS group, the REMS products and their application possibilities and operation. Furthermore, the user has access to the complete online catalogue and detailed technical documentation, information about current trade fair appearances and addresses of REMS contracted customer service workshops, download opportunities of sales documentation, operating instructions, parts lists, product illustrations and product films, opportunities to order sales documentation in various languages for postal dispatch, e-mail addresses for REMS contacts and much more.



The REMS products are exhibited and demonstrated at many national and international trade fairs.



Practical for the trade, clear for the customers – the REMS product presentation system.



The online information system at www.rems.de



REMS App



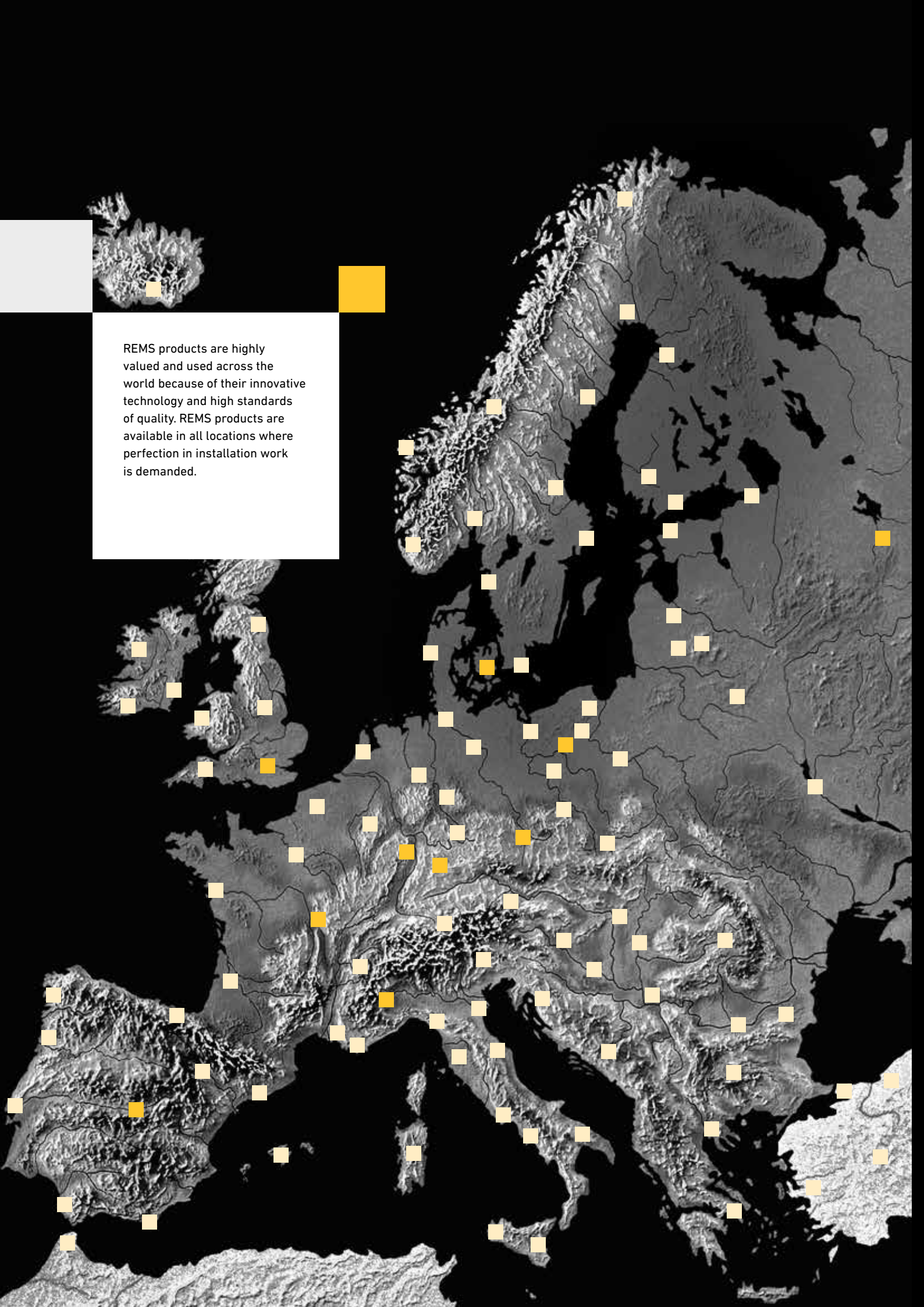

REMS products are highly valued and used across the world because of their innovative technology and high standards of quality. REMS products are available in all locations where perfection in installation work is demanded.

More than 20,000 trade partners in Europe: REMS products are available locally everywhere.

Innovative products and a high standard of quality open new markets for REMS. In the last years the market area has been continuously build-up and extended. Reliable trade partners throughout Europe and beyond guarantee that ever more customers can be persuaded of the quality of REMS.







REMS sets benchmarks for quality throughout Europe – the sales are carried out through the tight network of reliable trade partners in the whole of Europe which are in turn supported by more than 200 well trained REMS specialist advisors.



Sales subsidiaries in many countries deliver optimum conditions for users and trade outlets.



Threading Roll Grooving

	Hand die stocks	22
	Quick-change die heads S	23
	Electric die stocks	24
	Cordless die stock	28
	Threading machines	32
	Semi-automatic threading machines	42
	Pipe nipple chucks	48
	Thread-cutting oil	49
	Roll grooving attachments	50
	Roll grooving machine	51
	Cordless roll grooving machine	52
	Roll grooving machines	54

Proven quality die stock with excellent threading capabilities.

Pipe threads	1/8" – 2", 16 – 50 mm
Bolt threads	6 – 30 mm, 1/4" – 1"

Thread types see page 30, 31.

REMS eva – the plumber's die stock.
Excellent start-cutting and threading.
Steel ratchet lever, thickly plastic coated.
Only one type of quick-change die heads.
Indestructible quality dies.

System advantage

Large working range up to 1 1/4" and up to 2" with only **one** ratchet lever. Only **one** type of small, compact quick-change die heads and only **one** type of dies. The same quick-change die heads fit all REMS die stocks and other suitable makes of die stocks. Efficient and easy stocking. No confusion possible.

Ratchet lever

Robust. Ratchet lever in steel, thickly plastic coated, for convenient operation. Serrated plastic handle for secure grip. Easy adjustment of ratchet rotation. Perfect, secure seating of quick-change die heads, fast and easy change.

Quick-change die heads

Proven technology, high-grade material and precise machining of die head, dies and cover form a unit and ensure an excellent start-cutting performance and easy threading. No stalling of dies. Long, precise pipe guidance for perfect pipe centering. The chip holes which become wider at the outside enable good chip flow and clean threads. Quick-change die heads S for cutting pipe threads in hard-to-reach areas (page 23).

Dies

The proven, indestructible REMS quality dies with precise cutting geometry ensure an excellent start-cutting performance, easy threading and clean threads. Dies in a high-quality special-grade steel, fully tempered and hardened, for extremely long die life.

Thread-cutting oil

REMS Sanitol and REMS Spezial (page 49). Specially developed for threading. High cooling and lubricating effect. Essential for clean threads and longer service life of dies, tools and machines.

Nipple-threading

Efficient with REMS Nippelspanner 3/8" – 2" (page 48).



German Quality Product



Info

Supply format

REMS eva Set. Hand die stock with quick-change die heads. For pipe threads 1/8" – 2", 16 – 50 mm, bolt threads 6 – 30 mm, 1/4" – 1". For right and left-hand threads. 1 ratchet lever for the complete work range. Quick-change die heads with dies for pipe threads, tapered, ISO 7-1, EN 10226 (DIN 2999, BSPT) R right-hand respectively for threading electric conduit according to EN 60423 M. In sturdy steel case or in a cardboard box.

Description/Size	Art.-No.
REMS eva Set in steel case	
R 1/2 + 3/4 + 1	520014
R 1/2 + 3/4 + 1 + 1 1/4	520015
R 3/8 + 1/2 + 3/4 + 1 + 1 1/4	520013
R 1/2 + 3/4 + 1 + 1 1/4 + 1 1/2 + 2	520017
R 3/8 + 1/2 + 3/4 + 1 + 1 1/4 + 1 1/2 + 2	520016
M 16 + 20 + 25 + 32 (M x 1,5)	520010
M 20 + 25 + 32 + 40 (M x 1,5)	520009
REMS eva Set in cardboard box	
R 1/2 + 3/4	520008
R 1/2 + 3/4 + 1	520004
R 3/8 + 1/2 + 3/4 + 1 + 1 1/4	520003

REMS eva sets available for left-handed threads and NPT threads.

Accessories

Description	Art.-No.
Ratchet lever for complete work range	522000
Quick-change die heads S see page 23.	
Quick-change die heads, dies, attachment heads for button dies , see page 30 – 31.	
Steel case with inlay, for REMS eva 3/8" – 2"	526050
Thread-cutting oil see page 49.	
REMS Nippelspanner 3/8" – 2" see page 48.	
REMS Aquila 3B , pipe workstation with chain pipe vice on folding tripod stand, see page 105.	
REMS Aquila WB , chain pipe vice for workbench, see page 105.	



REMS quick-change die heads S

Accessories for REMS eva and other makes

For cutting pipe threads in hard-to-reach areas, e.g. caved wall, lay bare pipes, trench. Ideal for repair and renovation.

Pipe threads 3/8 – 1 1/4"

REMS quick-change die heads S – the trouble shooter for hard-to-reach areas.

Quick-change die heads S with specially mounted dies.

Additional, precise pipe guidance at the cover side ensure perfect pipe centering and easy start-cutting.

Extension of ratchet drive REMS eva for threading in caved areas.

Quick-change die heads S and extension fit into the ratchet lever REMS eva and other suitable die stocks.



German Quality Product



Info

Supply format

Die heads S Set. choice of quick-change die heads S for pipe threads tapered, right-hand ISO 7-1, EN 10226 (DIN 2999, BSPT) respectively Taper Pipe Thread ASME B1.20.1, Extension 300 mm. In sturdy steel case.

Description	Art.-No.
Set R 3/8 + 1/2 + 3/4	520025
Set R 1/2 + 3/4 + 1	520026
Set NPT 1/2 + 3/4 + 1	520056



Accessories

Description	Size	Art.-No.
Ratchet lever for complete work range		522000
Quick-change die heads S Pipe threads tapered, right ISO 7-1, EN 10226 (DIN 2999, BSPT)	R 3/8	521026
	R 1/2	521036
	R 3/4	521046
	R 1	521056
	R 1 1/4	521066
Extension 300 mm		522051
Steel case with inlay for ratchet lever, 4 quick-change die heads S and extension.		526052



Powerful, super handy electric tools for threading with unique support bracket. Ready to use anywhere, without vice. Ideal for repair, renovation, job site.

Pipe threads	1/8 – 1", 16 – 32 mm
Bolt threads	6 – 30 mm, 1/4 – 1"

Thread types see page 30, 31.

REMS Amigo E – the fastest, strongest and lightest up to 1".

System advantage

Only **one** type of small, compact quick-change die heads and only **one** type of dies for all REMS die stocks. Thus efficient and easy stocking. No confusion possible.

Support bracket

Solid, easy to use, supports the die stock against torque in both directions. Secure clamping through angular clamping spindle with self-supporting effect. Very simple mounting of die stock onto support bracket and pipe.

Design

Compact, robust, job site-proven. Can be used anywhere, even without vice. Slender design for working in confined areas. Drive unit only 3.4 kg, without die head. No heavy top, therefore single-hand operation possible. Perfect, secure seating of quick-change die heads.

Drive

Solid, compact, maintenance-free gear. Robust, powerful 950 W universal motor with 30 % power increase thanks to automatic carbon brush adjustment while changing the direction of rotation. Peak power input up to 1500 W. Fast threading time 35 – 27 rpm. Safety tip switch.

Quick-change die heads

Proven technology, high-grade material and precise machining of die head, dies and cover form a unit and ensure an excellent start-cutting performance and easy threading. No stalling of dies. Long, precise pipe guidance for perfect pipe centering. The chip holes which become wider at the outside enable good chip flow and clean threads.

Dies

The proven, indestructible REMS quality dies with precise cutting geometry ensure an excellent start-cutting performance, easy threading and clean threads. Dies in a high-quality special-grade steel, fully tempered and hardened, for extremely long die life.

Thread-cutting oil

REMS Sanitol and REMS Spezial (page 49). Specially developed for threading. High cooling and lubricating effect. Essential for clean threads and longer service life of dies, tools and machines.

Nipple-threading

Efficient with REMS Nippelspanner 3/8 – 1" (2") (page 48).



German Quality Product



Info

Supply format

REMS Amigo E Set. Electric die stock with quick-change die heads. For pipe threads 1/8 – 1", 16 – 32 mm, bolt threads 6 – 30 mm, 1/4 – 1". For right and left-hand threads. Drive unit with maintenance-free gear, powerful universal motor 230 V or 110 V, 50 – 60 Hz, 950 W, safety tip switch, power increase thanks to automatic carbon brush adjustment. Peak power input up to 1500 W. Right and left-hand rotation. Support bracket for both directions. REMS eva quick-change die heads for pipe threads, tapered, ISO 7-1, EN 10226 (DIN 2999, BSPT) R right-hand respectively for threading electric conduit according to EN 60423 M. In sturdy steel case.

Description	Art.-No.
Set R 1/2 + 3/4 + 1	530013
Set M 20 + 25 + 32	530014

REMS Amigo E Set for NPT threads available.

Accessories

Description	Art.-No.
Quick-change die heads, dies, attachment heads for button dies, see page 30 – 31.	
REMS Amigo E drive unit	530003
Support bracket	533000
REMS REG St 1/4 – 2", pipe deburrer, see page 99.	731700
Dual purpose holder for threading and sawing with REMS Amigo E, Amigo, Amigo 2 and REMS Tiger	543100
Ratchet lever see page 22.	522000
Thread-cutting oil see page 49.	
REMS Nippelspanner 3/8 – 2" see page 48.	
Steel case with inlay	536000



Powerful, easy-to-operate electric tool for threading with unique support bracket. Ready for use anywhere, without vice. Ideal for repair, renovation, job site.

Pipe threads $\frac{1}{8}$ – $1\frac{1}{4}$ " , 16 – 40 mm
Bolt threads 6 – 30 mm, $\frac{1}{4}$ – 1"

Thread types see page 30, 31.

REMS Amigo – the smallest, lightest, strongest and fastest up to $1\frac{1}{4}$ ".

System advantage

Only **one** type of small, compact quick-change die heads and only **one** type of dies for all REMS die stocks. Thus efficient and easy stocking. No confusion possible.

Support bracket

Solid, easy to use, supports the die stock against torque in both directions. Secure clamping through angular clamping spindle with self-supporting effect. Very simple mounting of die stock onto support bracket and pipe.

Design

Compact, robust, job site-proven. Can be used anywhere, even without vice. Slender design for working in confined areas. Drive unit only 3.5 kg, without die head. No heavy top, therefore single-hand operation possible. Perfect, secure seating of quick-change die heads.

Drive

Solid, compact, maintenance-free gear. Robust, powerful 1200 W universal motor with 30 % power increase thanks to automatic carbon brush adjustment while changing the direction of rotation. Peak power input up to 1800 W. Fast threading time 35 – 27 rpm. Safety tip switch.

Quick-change die heads

Proven technology, high-grade material and precise machining of die head, dies and cover form a unit and ensure an excellent start-cutting performance and easy threading. No stalling of dies. Long, precise pipe guidance for perfect pipe centering. The chip holes which become wider at the outside enable good chip flow and clean threads.

Dies

The proven, indestructible REMS quality dies with precise cutting geometry ensure an excellent start-cutting performance, easy threading and clean threads. Dies in a high-quality special-grade steel, fully tempered and hardened, for extremely long die life.

Thread-cutting oil

REMS Sanitol and REMS Spezial (page 49). Specially developed for threading. High cooling and lubricating effect. Essential for clean threads and longer service life of dies, tools and machines.

Nipple-threading

Efficient with REMS Nippelspanner $\frac{3}{8}$ – $1\frac{1}{4}$ " (2") (page 48).



German Quality Product



Supply format

REMS Amigo Set. Electric die stock with quick-change die heads. For pipe threads $\frac{1}{8}$ – $1\frac{1}{4}$ " , 16 – 40 mm, bolt threads 6 – 30 mm, $\frac{1}{4}$ – 1". For right and left-hand threads. Drive unit with maintenance-free gear, powerful universal motor 230 V or 110 V, 50 – 60 Hz, 1200 W, safety tip switch, power increase thanks to automatic carbon brush adjustment. Peak power input up to 1800 W. Right and left-hand rotation, overload protection switch. Support bracket for both directions. REMS eva quick-change die heads for pipe threads, tapered, ISO 7-1, EN 10226 (DIN 2999, BSPT) R right-hand respectively for threading electric conduit according to EN 60423 M. In sturdy steel case.

Description	Art.-No.
Set R $\frac{1}{2}$ + $\frac{3}{4}$ + 1 + $1\frac{1}{4}$	530020
Set M 16 + 20 + 25 + 32 (M x 1,5)	530022
Set M 20 + 25 + 32 + 40 (M x 1,5)	530023

REMS Amigo Set for NPT threads available.

Accessories

Description	Art.-No.
Quick-change die heads, dies, attachment heads for button dies, see page 30 – 31.	
REMS Amigo drive unit	530000
Support bracket	533000
REMS REG St $\frac{1}{4}$ – 2" , pipe deburrer, see page 99.	731700
Dual purpose holder for threading and sawing with REMS Amigo E, Amigo, Amigo 2 and REMS Tiger	543100
Ratchet lever see page 22.	522000
Thread-cutting oil see page 49.	
REMS Nippelspanner $\frac{3}{8}$ – 2" see page 48.	
Steel case with inlay	536000



REMS Amigo 2

Electric die stock with quick-change die heads

Powerful, easy-to-operate electric tool for threading with unique support bracket. Ready for use any-where, without vice. Ideal for repair, renovation, job site.

Pipe threads	1/8" – 2", 16 – 50 mm
Bolt threads	6 – 30 mm, 1/4" – 1"

Thread types see page 30, 31.

REMS Amigo 2 – extremely strong up to 2".

System advantage

Only **one** type of small, compact quick-change die heads and only **one** type of dies for all REMS die stocks. Thus efficient and easy stocking. No confusion possible.

Support bracket

Solid, easy to use, supports the die stock against torque in both directions. Secure clamping through angular clamping spindle with self-supporting effect. Very simple mounting of die stock onto support bracket and pipe.

Design

Compact, robust, job site-proven. Can be used anywhere, even without vice. Slender design for working in confined areas. Drive unit only 6.5 kg, without die head.

Drive

Solid, maintenance-free gear. Robust 1700 W universal motor with 30 % power increase thanks to automatic carbon brush adjustment while changing the direction of rotation. Fast threading time 30 – 18 rpm. Safety tip switch.

Quick-change die heads

Proven technology, high-grade material and precise machining of die head, dies and cover form a unit and ensure an excellent start-cutting performance and easy threading. No stalling of dies. Long, precise pipe guidance for perfect pipe centering. The chip holes which become wider at the outside enable good chip flow and clean threads.

Dies

The proven, indestructible REMS quality dies with precise cutting geometry ensure an excellent start-cutting performance, easy threading and clean threads. Dies in a high-quality special-grade steel, fully tempered and hardened, for extremely long die life.

Thread-cutting oil

REMS Sanitol and REMS Spezial (page 49). Specially developed for threading. High cooling and lubricating effect. Essential for clean threads and longer service life of dies, tools and machines.

Nipple-threading

Efficient with REMS Nippelspanner 3/8" – 1" (2") (page 48).



German Quality Product



Info



Supply format

REMS Amigo 2 Set. Electric die stock with quick-change die heads. For pipe threads 1/8" – 2", 16 – 50 mm, bolt threads 6 – 30 mm, 1/4" – 1". For right and left-hand threads. Drive unit with maintenance-free gear, powerful universal motor 230 V or 110 V, 50 – 60 Hz, 1700 W, safety tip switch, power increase thanks to automatic carbon brush adjustment, right and left-hand rotation. Support bracket for both directions. REMS eva quick-change die heads for pipe threads, tapered, ISO 7-1, EN 10226 (DIN 2999, BSPT) R right-hand respectively for threading electric conduit according to EN 60423 M. In sturdy steel case.

Description	Art.-No.
Set R 1/2 + 3/4 + 1 + 1 1/4 + 1 1/2 + 2	540020
Set M 20 + 25 + 32 + 40 + 50 (M x 1,5)	540022

REMS Amigo 2 Set for NPT threads available.
Other voltages on request.



Accessories

Description	Art.-No.
Quick-change die heads, dies, attachment heads for button dies, see page 30 – 31.	
REMS Amigo 2 drive unit	540000
Support bracket Amigo 2	543000
REMS REG St 1/4" – 2" , pipe deburrer, see page 99.	731700
Dual purpose holder for threading and sawing with REMS Amigo E, Amigo, Amigo 2 and REMS Tiger	543100
Ratchet lever see page 22.	522000
Thread-cutting oil see page 49.	
REMS Nippelspanner 3/8" – 2" see page 48.	
Steel case with inlay	546000



REMS Amigo 2 Compact

Electric die stock with quick-change die heads

Powerful, easy-to-operate electric tool for threading with unique support bracket. Ready for use any-where, without vice. Ideal for repair, renovation, job site.

Pipe threads $\frac{1}{8}$ – 2", 16 – 50 mm
 Bolt threads 6 – 30 mm, $\frac{1}{4}$ – 1"

Thread types see page 30, 31.

REMS Amigo 2 Compact – The smallest and lightest up to 2".

System advantage

Only **one** type of small, compact quick-change die heads and only **one** type of dies for all REMS die stocks. Thus efficient and easy stocking. No confusion possible.

Support bracket

Solid, easy to use, supports the die stock against torque in both directions. Secure clamping through angular clamping spindle with self-supporting effect. Very simple mounting of die stock onto support bracket and pipe.

Design

Compact, robust, job site-proven. Can be used anywhere, even without vice. Slender design for working in confined areas. Drive unit only 4.9 kg, without die head. Perfect seating of quick-change die heads.

Drive

Solid, maintenance-free gear. Robust 1200 W universal motor with 30 % power increase thanks to automatic carbon brush adjustment while changing the direction of rotation. Peak power input up to 1800 W. Fast threading time 30 – 18 rpm. Safety tip switch.

Quick-change die heads

Proven technology, high-grade material and precise machining of die head, dies and cover form a unit and ensure an excellent start-cutting performance and easy threading. No stalling of dies. Long, precise pipe guidance for perfect pipe centering. The chip holes which become wider at the outside enable good chip flow and clean threads.

Dies

The proven, indestructible REMS quality dies with precise cutting geometry ensure an excellent start-cutting performance, easy threading and clean threads. Dies in a high-quality special-grade steel, fully tempered and hardened, for extremely long die life.

Thread-cutting oil

REMS Sanitol and REMS Spezial (page 49). Specially developed for threading. High cooling and lubricating effect. Essential for clean threads and longer service life of dies, tools and machines.

Nipple-threading

Efficient with REMS Nippelspanner $\frac{3}{8}$ – 1" (2") (page 48).



German Quality Product



Info



Supply format

REMS Amigo 2 Compact Set. Electric die stock with quick-change die heads. For pipe threads $\frac{1}{8}$ – 2", 16 – 50 mm, bolt threads 6 – 30 mm, $\frac{1}{4}$ – 1". For right and left-hand threads. Drive unit with maintenance-free gear, powerful universal motor 230 V or 110 V, 50 – 60 Hz, 1200 W, safety tip switch, power increase thanks to automatic carbon brush adjustment. Peak power input up to 1800 W. Right and left-hand rotation. Overload protection. Support bracket for both directions. REMS eva quick-change die heads for pipe threads, tapered, ISO 7-1, EN 10226 (DIN 2999, BSPT) R right-hand respectively for threading electric conduit according to DIN DN 60423 M. In sturdy steel case.

Description	Art.-No.
Set R $\frac{1}{2}$ + $\frac{3}{4}$ + 1 + 1 $\frac{1}{4}$	540023
Set R $\frac{1}{2}$ + $\frac{3}{4}$ + 1 + 1 $\frac{1}{4}$ + 1 $\frac{1}{2}$ + 2	540024
Set M 20 + 25 + 32 + 40 + 50 (M x 1,5)	540025

REMS Amigo 2 Compact Set for NPT threads available.
 Other voltages on request.



Accessories

Description	Art.-No.
Quick-change die heads, dies, attachment heads for button dies, see page 30 – 31.	
REMS Amigo 2 Compact drive unit	540001
Support bracket Amigo 2 Compact	543010
REMS REG St $\frac{1}{4}$ – 2" , pipe deburrer, see page 99.	731700
Ratchet lever see page 22.	522000
Thread-cutting oil see page 49.	
REMS Nippelspanner $\frac{3}{8}$ – 2" see page 48.	
Steel case with inlay	546000



REMS Amigo 22V

Cordless die stock with quick-change die heads

Powerful, mobile, handy electric tool for threading with unique support bracket. Ready for use any-where, without vice. Ideal for repair, renovation, job site. Li-Ion 22V Technology. For battery and corded operation.

Pipe threads	1/8 – 1", 16 – 32 mm
Bolt threads	6 – 30 mm, 1/4 – 1"

Thread types see page 30, 31.

REMS Amigo 22V – mobile, handy, light.

Li-Ion 21.6V, 9.0 Ah battery, for approx. 52 3/4" threads with one battery charge*.

System advantage

Only **one** type of small, compact quick-change die heads and only **one** type of dies for all REMS die stocks. Thus efficient and easy stocking. No confusion possible.

Support bracket

Solid, easy to use, supports the die stock against torque in both directions. Secure clamping through angular clamping spindle with self-supporting effect. Very simple mounting of die stock onto support bracket and pipe.

Design

Compact, robust, job site-proven. Can be used anywhere, even without vice. Slender design for working in confined areas. Mobile, handy, light. Drive unit with battery pack weighs only 5.6 kg. Practical D-shaped handle with soft grip. Perfect seating of quick-change die heads. Machine status check with overload protection of the drive unit against too high currents, with overheating protection by motor temperature monitoring (NTC), with electronic battery charging status check by a 2-coloured green/red LED.

Drive

Solid, maintenance-free gear. Powerful battery motor 21.6V, with large power reserve, 500W output. High cutting speed 27 – 20 rpm. Safety tip switch.

Battery or mains operation

Li-Ion 22V Technology. Highly resistant Li-Ion 21.6V batteries with 9.0Ah capacity for long service life. Light and powerful, for 52 3/4" threads with one battery charge*. Graduated charging status check by coloured LEDs. Operating temperature range –10 to +60 °C. No memory effect for maximum battery power. Rapid charger 100 – 240V, 90 W. Rapid charger 100 – 240V, 290 W, for shorter charging times, as accessory. Voltage supply 220 – 240V/21.6V, 40 A output, for mains operation instead of Li-Ion battery 21.6 V, as accessory.

Quick-change die heads

Proven technology, high-grade material and precise machining of die head, dies and cover form a unit and ensure an excellent start-cutting performance and easy threading. No stalling of dies. Long, precise pipe guidance for perfect pipe centering. The chip holes which become wider at the outside enable good chip flow and clean threads.

Dies

The proven, indestructible REMS quality dies with precise cutting geometry ensure an excellent start-cutting performance, easy threading and clean threads. Dies in a high-quality special-grade steel, fully tempered and hardened, for extremely long die life.

Thread-cutting oil

REMS Sanitol and REMS Spezial (page 49). Specially developed for threading. High cooling and lubricating effect. Essential for clean threads and longer service life of dies, tools and machines.

Nipple-threading

Efficient with REMS Nippelspanner 3/8 – 1" (2") (page 48).



German Quality Product



Info



Supply format

REMS Amigo 22V Set. Cordless die stock with quick-change die heads. For pipe threads $\frac{1}{8}$ –1", 16–32 mm, bolt threads 6–30 mm, $\frac{1}{4}$ –1". For right and left-hand threads. Drive unit with maintenance-free gear, powerful battery motor 21.6V, 500 W. Safety switch. Right and left-hand rotation, machine status check with overload protection, temperature monitoring, battery charging status check. Li-Ion 21.6V, 9.0Ah battery, 100–240V, 50–60 Hz, 90 W rapid charger. Support bracket for both directions. REMS eva quick-change die heads for pipe threads, tapered, ISO 7-1, EN 10226 (DIN 2999, BSPT) R right-hand respectively for threading electric conduit according to DIN DN 60423 M. In sturdy steel case.

Description	Art.-No.
Set R $\frac{1}{2}$ + $\frac{3}{4}$ + 1	530015
Set M 20 + 25 + 32	530016

REMS Amigo 22V Set for NPT threads available.
Other voltages on request.



Accessories

Description	Art.-No.
Quick-change die heads, dies, attachment heads for button dies, see page 30–31.	
REMS Akku-Amigo 22V drive unit, without battery	530004
Support bracket Amigo 2 Compact	543010
Battery Li-Ion 21.6V, 9.0Ah	571583
Rapid charger 100–240V, 50–60 Hz, 90W	571585
Rapid charger 100–240V, 50–60 Hz, 290W	571587
Voltage supply 220–240V/21.6V, 50–60 Hz, 40A, for mains operation instead of battery Li-Ion 21.6V	571578
REMS REG St $\frac{1}{4}$–2", pipe deburrer, see page 99.	731700
Ratchet lever see page 22.	522000
Thread-cutting oil see page 49.	
REMS Nippelspanner $\frac{3}{8}$–2" see page 48.	
Steel case with inlay	566030
REMS Lumen 2800 22V, cordless LED flood light, see page 111	



REMS quick-change die heads

Accessories for REMS die stocks and other makes

REMS quick-change die heads

Proven technology, high-grade material and precise machining of die head, dies and cover form a unit and ensure an excellent start-cutting performance and easy threading. No stalling of dies. Long, precise pipe guidance for perfect pipe centering. The chip holes which become wider at the outside enable good chip flow and clean threads.

Thread type	Size	Art.-No.
Pipe threads R tapered, right-hand ISO 7-1, EN 10226 (DIN 2999, BSPT)	R 1/8	521000
	R 1/4	521010
	R 3/8	521020
	R 1/2	521030
	R 3/4	521040
	R 1	521050
	R 1 1/4	521060
	R 1 1/2	521070
	R 2	521080
Pipe threads R tapered, left-hand ISO 7-1, EN 10226 (DIN 2999, BSPT)	R 1/8 LH	521100
	R 1/4 LH	521110
	R 3/8 LH	521120
	R 1/2 LH	521130
	R 3/4 LH	521140
	R 1 LH	521150
	R 1 1/4 LH	521160
	R 1 1/2 LH	521170
R 2 LH	521180	
Pipe threads NPT tapered, right-hand Taper Pipe Thread ASME B1.20.1	NPT 1/8	521200
	NPT 1/4	521210
	NPT 3/8	521220
	NPT 1/2	521230
	NPT 3/4	521240
	NPT 1	521250
	NPT 1 1/4	521260
	NPT 1 1/2	521270
	NPT 2	521280
Threads M for electric conduit EN 60423	M 16 x 1.5	521300
	M 20 x 1.5	521310
	M 25 x 1.5	521320
	M 32 x 1.5	521330
	M 40 x 1.5	521340
	M 50 x 1.5	521350



Right-hand pipe thread



Left-hand pipe thread

German Quality Product

REMS dies

Accessories for REMS die stocks

REMS dies

The proven, indestructible REMS quality dies with precise cutting geometry ensure an excellent start-cutting performance, easy threading and clean threads. Dies in a high-quality special-grade steel, fully tempered and hardened, for extremely long die life.

Thread type	Size	Art.-No.
Pipe threads R tapered, right-hand ISO 7-1, EN 10226 (DIN 2999, BSPT)	R 1/8	521002
	R 1/4	521012
	R 3/8	521022
	R 1/2	521032
	R 3/4	521042
	R 1	521052
	R 1 1/4	521062
	R 1 1/2	521072
	R 2	521082
Pipe threads R tapered, left-hand ISO 7-1, EN 10226 (DIN 2999, BSPT)	R 1/8 LH	521102
	R 1/4 LH	521112
	R 3/8 LH	521122
	R 1/2 LH	521132
	R 3/4 LH	521142
	R 1 LH	521152
	R 1 1/4 LH	521162
	R 1 1/2 LH	521172
R 2 LH	521182	
Pipe threads NPT tapered, right-hand Taper Pipe Thread ASME B1.20.1	NPT 1/8	521202
	NPT 1/4	521212
	NPT 3/8	521222
	NPT 1/2	521232
	NPT 3/4	521242
	NPT 1	521252
	NPT 1 1/4	521262
	NPT 1 1/2	521272
	NPT 2	521282
Threads M for electric conduit EN 60423	M 16 x 1.5	521302
	M 20 x 1.5	521312
	M 25 x 1.5	521322
	M 32 x 1.5	521332
	M 40 x 1.5	521342
	M 50 x 1.5	521352



German Quality Product

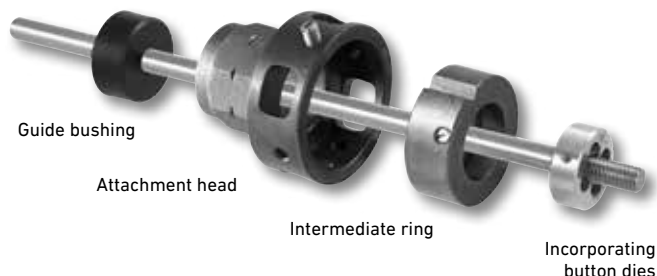

Attachment heads

Attachment heads for incorporating standard, round button dies of all thread types. Locking of button dies to the attachment head with stud bolt.

Description	Size	Art.-No.
Attachment head for button dies	Ø 65 mm	731200
Attachment head for button dies	G 1¼	731250
Attachment head for button dies	Ø 105 mm	541401

Intermediate rings

Intermediate rings for different outside diameters of button dies.

Description	Size	I.D. mm	Art.-No.
Intermediate rings to attachment head 731200	M 6-9	20/25	731205
	M 10-11	30	731210
	M 12-14 (Pg 7-9)	38	731220
	M 16-20 (Pg 11-13,5)	45	731230
	M 22-24 (Pg 16)	55	731240
without intermediate ring	M 27-30 (Pg 21-29)	65	
Intermediate rings to attachment head 541401	Ø 65/105 (Pg 21-29)	65	541404
	Ø 75/105	75	541406
	Ø 90/105 (Pg 36)	90	541410
without intermediate ring	Pg 42-48	105	

Guide bushings

Guide bushings for easy and concentric start-cutting.

Description	Size	Art.-No.
Guide bushings to attachment head 731200	Ø 6	731301
	Ø 8	731302
	Ø 10	731303
	Ø 12	731304
	Ø 14	731305
	Ø 16	731306
	Ø 18	731307
	Ø 20	731308
	Ø 22	731309
	Ø 24	731310
	Ø 27	731311
	Ø 30	731312
	Ø 12.8 (Pg 7)	731320
	Ø 15.5 (Pg 9)	731321
	Ø 18.9 (Pg 11)	731322
	Ø 20.7 (Pg 13.5)	731323
	Ø 22.8 (Pg 16)	731324
Ø 28.6 (Pg 21)	731325	
Ø 37.3 (Pg 29)	731326	
Guide bushings to attachment head 541401	Ø 28.6 (Pg 21)	541413
	Ø 37.3 (Pg 29)	541414
	Ø 47.3 (Pg 36)	541415
	Ø 54.3 (Pg 42)	541416



German Quality Product

Proven high performance machine for threading, cutting, deburring, threading of nipples, roll grooving.

For installation, metalworking, industry.

For job site and workshop.

Pipe threads (1/16) 1/8–2", 16–63 mm

Bolt threads (6) 10–60 mm, 1/4–2"

Thread types see page 40.

Pipe grooving with

REMS roll grooving attachment DN 25–200
1–8"

REMS Tornado – a class of its own.

Automatic chuck. Universal automatic die head.

Automatic lubrication and cooling.

Operating principle

Rotating material - stationary tools.

Design

Robust, job site-proven. Favourable size and weight, e.g. REMS Tornado 2000 complete only 50 kg. Large work and chip compartment. Easy handling of chip tray. Adjustable height material support.

2 versions:

- Portable version with 3 tubular legs, with removable large oil basin and chip tray.
- Version T with integrated, even larger oil basin and chip tray. For workbench. Stand, collapsible wheel stand or wheel stand with material shelf, as an accessory, for easy transport, optimum working height and stable positioning.

Drive

Extremely powerful and fast, e.g. R 2" thread in only 15 s. Completely maintenance-free gear which runs in a sealed oil bath.

Choice of 3 powerful motors:

- Strong universal motor, 1700 W. overload protection. Spindle speed 53 rpm.
- Pole-reversible capacitor motor, 2100 W. Overload protection. 2 spindle speeds 52 and 26 rpm, also under full load. **Extremely quiet running.**
- Pole-reversible 3-induction motor, 2000 W. Overload protection. 2 spindle speeds 52 and 26 rpm, also under full load. **Extremely quiet running.**

Operator-friendly safety foot switch with emergency-stop, 2-step. Foot switch, can be loaded with the full body weight during operation.

Automatic chuck

2 automatic chucks with self-centering clamping jaws for easy and fast clamping and release of the material. Self-tightening, hence maximum clamping force. No slipping of pipes. Collets are available for clamping pipes $\varnothing 1/8''$ and bolts <math>< \varnothing 10\text{ mm}</math>.

Automatic lubrication and cooling

Robust, proven oil pump with high pumping volume. Optimized oil distribution directly onto the threading point through the die head ensures clean threads and long service life of dies, gear and motor.

Universal automatic die head

Only **one** universal automatic die head for all threads, including long threads; automatic opening with automatic thread-length-stop for tapered threads. Fast and easy adjustment of thread size. Easy-to-read thread-size scale. Simple and fast change of dies through lock-in positioning in die holder.

Dies

The proven, indestructible REMS quality dies with precise cutting geometry ensure an excellent start-cutting performance, easy threading and clean threads. Dies in a high-quality special-grade steel, fully tempered and hardened, for extremely long die life.

Pipe cutter

Self centering. Robust body made of forged steel. Ergonomic, wide handle for powerful infeed of spindle. Specially hardened cutter wheel in tough-hard REMS die-steel ensures long service life.

Inner pipe deburrer

Robust, easy-to-handle deburring device with adjustable deburring positioning. Specially hardened and designed deburring blade ensures easy deburring and extremely long service life. Two cutting edges for optimum chip flow, specially for small diameters.

Thread-cutting oil

REMS Sanitol and REMS Spezial (page 49). Specially developed for threading. High cooling and lubricating effect. Essential for clean threads and longer service life of dies, tools and machines.

Nipple-threading

Efficient with the automatic internal clamping REMS Nippelfix 1/2–2" (4") or with the manual internal clamping REMS Nippelspanner 3/8–2" (page 48).



German Quality Product



Info



Choice of 3 powerful motors.



REMS roll grooving attachment

Robust, compact roll grooving attachment with oil hydraulic in-feed for pipe grooving of grooved coupling systems DN 25–300, 1–12" (page 50). Roll grooving with REMS Tornado up to DN 200, 8".



Version T

Wheel stand (accessory)



Version T

Collapsible wheel stand (Accessory)

Supply format

REMS Tornado. Threading machine for pipe threads (1/16) 1/8–2", 16–63 mm, bolt threads (6) 10–60 mm, 1/4–2". With maintenance-free gear, safety foot switch with emergency-stop, 2 automatic chucks, automatic lubrication and cooling. With tool set consisting of one universal automatic die head for all threads, also long threads, automatic opening, with automatic thread-length-stop for tapered threads. Dies for pipe threads, tapered, ISO 7-1, EN 10226 (DIN 2999, BSPT) R 1/2–3/4" and R 1–2" right-hand, pipe cutter, inner pipe deburrer, pressing lever, adjustable height material support. Choice of 3 motors. Portable version with 3 tubular legs, with removable, large oil and chip tray. Version T with integrated, even bigger oil tray and chip tray, for workbench, stand, collapsible wheel stand or wheel stand with material shelf. In a carton.

Description	Version	Art.-No.
2000	Universal motor 230 V or 110 V, 50–60 Hz, 1700 W. 53 rpm. Portable, 3 legs.	340200
2010	Pole-reversible capacitor, motor 230 V, 50 Hz, 2100 W. 52/26 rpm, also under full load. Extremely quiet running. Portable, 3 legs.	340201
2020	Pole-reversible 3~ induction motor 400 V, 50 Hz, 2000 W. 52/26 rpm, also under full load. Extremely quiet running. Portable, 3 legs.	340202
2000 T	Universal motor 230 V or 110 V, 50–60 Hz, 1700 W. 53 rpm. For work bench, stand or wheel stand.	340206
2010 T	Pole-reversible capacitor motor 230 V, 50 Hz, 2100 W. 52/26 rpm, also under full load. Extremely quiet running. For work bench, stand or wheel stand.	340207
2020 T	Pole-reversible 3~ induction motor 400 V, 50 Hz, 2000 W. 52/26 rpm, also under full load. Extremely quiet running. For work bench, stand or wheel stand.	340208

Other voltages and NPT versions on request.

Accessories

Description	Art.-No.
Stand	344105
Wheel stand with material shelf	344100
Collapsible wheel stand	344150
Dies see page 40.	
Universal automatic die head 1/16–2" quick-change die head instead of changing the dies	341000
REMS cutter wheel St 1/8–4", s 8	341614
Thread-cutting oil see page 49.	
Nipple holder see page 48.	
REMS Herkules material supports, see page 107.	
REMS roll grooving attachment for pipe grooving, see page 50.	347000



Robust, compact high performance machine for threading, cutting, deburring, threading of nipples, roll grooving. For installation, metalworking, industry. For job site and workshop.

Pipe threads	(1/16) 1/8 – 2", 16 – 63 mm
Bolt threads	(6) 8 – 60 mm, 1/4 – 2"

Thread types see page 40.

Grooving of pipes with REMS roll grooving attachment	DN 25 – 300 1 – 12"
---	------------------------

REMS Magnum – the compact up to 2".

Operating principle

Rotating material – stationary tools.

Design

Robust, compact, job site-proven design. Favorable size and weight, e.g. REMS Magnum 2000 L-T only 62 kg. Large work and chip compartment. Tool support.

2 versions:

- Light version L-T with removable large oil basin and chip tray.
 - Version T with integrated, even larger oil basin and chip tray.
- For workbench. Stand, collapsible wheel stand or wheel stand with material shelf, as an accessory, for easy transport, optimum working height and stable positioning.

Drive

Extremely powerful and fast, e.g. thread R 2" in only 15 s. Completely maintenance-free gear which runs in a sealed oil bath.

Choice of 3 powerful motors:

- Strong universal motor, 1700 W.
Overload protection. Spindle speed 53 rpm.
- Pole-reversible capacitor motor, 2100 W.
Overload protection. 2 spindle speeds 52 and 26 rpm, also under full load. **Extremely quiet running.**
- Pole-reversible 3~ induction motor, 2000 W.
Overload protection. 2 spindle speeds 52 and 26 rpm, also under full load. **Extremely quiet running.**

Operator-friendly safety foot switch with emergency-stop, 2-step. Foot switch, can be loaded with the full body weight during operation.

Chuck

Proven quick-action hammer chuck, self-tightening. No slipping of pipes. Large space between chuck and centering device ensures secure clamping of long pipes. Rear centering device for alignment of the material. Collets are available for clamping pipes $\varnothing 1/8''$ and bolts <math>< \varnothing 8\text{ mm}</math>.

Automatic lubrication and cooling

Robust, proven oil pump with high pumping volume. Optimized oil distribution directly onto the threading point through the die head ensures clean threads and long service life of dies, gear and motor.

Universal automatic die head

Only **one** universal automatic die head for all threads, including long threads; automatic opening with automatic thread-length-stop for tapered threads. Fast and easy adjustment of thread size. Simple and fast change of dies through lock-in positioning in die holder.

Dies

The proven, indestructible REMS quality dies with precise cutting geometry ensure an excellent start-cutting performance, easy threading and clean threads. Dies in a high-quality special-grade steel, fully tempered and hardened, for extremely long die life.

Pipe cutter

Self centering. Robust body made of forged steel. Ergonomic, wide handle for powerful infeed of spindle. Specially hardened cutter wheel in tough-hard REMS die-steel ensures long service life.

Inner pipe deburrer

Robust, easy-to-handle deburring device for adjustable deburring positioning. Specially hardened and designed deburring blade ensures easy deburring and extremely long service life. Two cutting edges for optimum chip flow, specially for small diameters.

Thread-cutting oil

REMS Sanitol and REMS Spezial (page 49). Specially developed for threading. High cooling and lubricating effect. Essential for clean threads and longer service life of dies, tools and machines.

Nipple-threading

Efficient with automatic internal clamping REMS Nippelfix 1/2 – 2" (4") or with manual internal clamping REMS Nippelspanner 3/8 – 2" (page 48).

REMS roll grooving attachment

Robust, compact roll grooving attachment with oil hydraulic in-feed for pipe grooving of grooved coupling systems DN 25–300, 1–12" (page 50).



German Quality Product



Info



Choice of 3 powerful motors.





Supply format

REMS Magnum. Threading machine for pipe threads ($\frac{1}{16}$) $\frac{1}{8}$ –2", 16–63 mm, bolt thread (6) 8–60 mm, $\frac{1}{4}$ –2". With maintenance-free gear, safety foot switch with emergency-stop, self-tightening quick-action hammer chuck, rear centering device, automatic lubrication and cooling. With complete tool set consisting of one universal automatic die head for all threads, also long threads; automatic opening, with automatic thread-length-stop for tapered threads, dies for pipe threads, tapered, ISO 7-1, EN 10226 (DIN 2999, BSPT) R $\frac{1}{2}$ – $\frac{3}{4}$ " and R 1–2" right-hand, pipe cutter, inner pipe deburrer, pressing lever. Tool support. Choice of 3 motors. Version L-T with removable large oil basin and chip tray. Version T with integrated, even bigger oil tray and chip tray. For workbench, stand, collapsible wheel stand or wheel stand with material shelf. In a carton.

Description	Version	Art.-No.
2000 L-T	Universal motor 230 V or 110 V, 50–60 Hz, 1700 W. 53 rpm.	340226
2010 L-T	Pole-reversible capacitor motor 230 V, 50 Hz, 2100 W. 52/26 rpm, also under full load. Extremely quiet running.	340227
2020 L-T	Pole-reversible 3~ induction motor 400 V, 50 Hz, 2000 W. 52/26 rpm, also under full load. Extremely quiet running.	340228
2000 T*	Universal motor 230 V or 110 V, 50–60 Hz, 1700 W. 53 rpm.	340220
2010 T*	Pole-reversible capacitor motor 230 V, 50 Hz, 2100 W. 52/26 rpm, also under full load. Extremely quiet running.	340221
2020 T*	Pole-reversible 3~ induction motor 400 V, 50 Hz, 2000 W. 52/26 rpm, also under full load. Extremely quiet running.	340222

Other voltages and NPT versions on request.

*T versions with REMS roll grooving device for roll grooving can only be used up to DN 200, 8".

Accessories

Description	Art.-No.
Stand	344105
Wheel stand with material shelf	344100
Collapsible wheel stand	344150
Dies see page 40.	
Universal automatic die head $\frac{1}{16}$ –2" quick-change die head instead of changing the dies	341000
Changeover valve , for reversing flow direction of the coolant-lubricant pump for cutting left-handed threads with REMS Magnum 2010, 2020, 3010, 3020, 4010 and 4020	342080
REMS cutter wheel St $\frac{1}{8}$ –4", s 8	341614
Thread-cutting oil see page 49.	
Nipple holder see page 48.	
REMS Herkules material supports, see page 107.	
REMS roll grooving attachment for pipe grooving, see page 50.	347000



Robust, compact high performance machine for threading, cutting, deburring, threading of nipples, roll grooving. For installation, metalworking, industry. For job site and workshop.

Pipe threads	(1/16) 1/2–3", 16–63 mm
Bolt threads	(6) 18–60 mm, 1/2–2"

Thread types see page 40.

Pipe grooving with REMS roll grooving attachment	DN 25–300 1–12"
---	--------------------

**REMS Magnum – the super machine up to 3".
Exceptionally round and clean threads up to 3"
by using 5 threading dies.**

Operating principle

Rotating material – stationary tools.

Design

Robust, compact, job site-proven design. Favorable size and weight, e.g. REMS Magnum 3000 L-T only 79 kg. Large work and chip compartment. Tool support.

2 versions:

- Light version L-T with removable large oil basin and chip tray.
 - Version T with integrated, even larger oil basin and chip tray.
- For workbench. Stand, collapsible wheel stand or wheel stand with material shelf, as an accessory, for easy transport, optimum working height and stable positioning.

Drive

Extremely powerful and fast. Completely maintenance-free gear which runs in a sealed oil bath.

Choice of 3 powerful motors:

- Strong universal motor, 1700 W.
Overload protection. Spindle speed 23 rpm.
- Pole-reversible capacitor motor, 2100 W.
Overload protection. 2 spindle speeds 20 and 10 rpm, also under full load. **Extremely quiet running.**
- Pole-reversible 3~ induction motor, 2000 W.
Overload protection. 2 spindle speeds 20 and 10 rpm, also under full load. **Extremely quiet running.**

Operator-friendly safety foot switch with emergency-stop, 2-step. Foot switch, can be loaded with the full body weight during operation.

Chuck

Proven quick-action hammer chuck, self-tightening. No slipping of pipes. Large space between chuck and centering device ensures secure clamping of long pipes. Rear centering device for alignment of the material. Collets are available for clamping pipes \varnothing 1/2" and bolts \varnothing 18 mm.

Automatic lubrication and cooling

Robust, proven oil pump with high pumping volume. Optimized oil distribution directly onto the threading point through the die head ensures clean threads and long service life of dies, gear and motor.

Universal automatic die head

Only 1 universal automatic die head each for the sizes 1/16–2" and 2 1/2–3" for all threads, including long threads; automatic opening with automatic thread-length-stop for tapered threads. 5 dies 2 1/2–3" ensure a favourable distribution of the cutting force onto the pipe, hence round and clean threads. Fast and easy adjustment of thread size. Simple and fast change of dies through lock-in positioning in die holder.

Dies

The proven, indestructible REMS quality dies with precise cutting geometry ensure an excellent start-cutting performance, easy threading and clean threads. Dies in a high-quality special-grade steel, fully tempered and hardened, for extremely long die life.

Pipe cutter

Self centering. Robust body made of forged steel. Ergonomic, wide handle for powerful infeed of spindle. Specially hardened cutter wheel in tough-hard REMS die-steel ensures long service life.

Inner pipe deburrer

Robust, easy-to-handle deburring device for adjustable deburring positioning. Specially hardened and designed deburring blade ensures easy deburring and extremely long service life. Two cutting edges for optimum chip flow, specially for small diameters.

Tool sets

For 2 1/2–3" and 1/2–2" one complete tool set each adapted to the work range with universal die head, pipe cutter, inner-pipe-deburring device, pressing lever, dies.



German Quality Product



Choice of 3 powerful motors.



Thread-cutting oil

REMS Sanitol and REMS Spezial (page 49). Specially developed for threading. High cooling and lubricating effect. Essential for clean threads and longer service life of dies, tools and machines.

Nipple-threading

Efficient with automatic internal clamping REMS Nippelfix ½–3" (4") or with manual internal clamping REMS Nippelspanner (page 48).

REMS roll grooving attachment

Robust, compact roll grooving attachment with oil hydraulic in-feed for pipe grooving of grooved coupling systems DN 25–300, 1–12" (page 50).

Supply format

REMS Magnum. Threading machine for pipe threads (1/16) ½–3", 16–63 mm, bolt threads (6) 18–60 mm, ½–2". With maintenance-free gear, safety foot switch with emergency-stop, self-tightening quick-action hammer chuck, rear centering device, automatic lubrication and cooling. With tool sets 1/16–2" and/or 2½–3", each consisting of universal automatic die head for all threads, also long threads; automatic opening, with automatic thread-length-stop for tapered threads, dies for pipe threads, tapered, ISO 7-1, EN 10226 (DIN 2999, BSPT) R right-hand, pipe cutter, inner pipe deburrer, pressing lever. Tool support. Choice of 3 motors. Version L-T with removable large oil basin and chip tray. Version T with integrated, even larger oil basin and chip tray. For workbench, stand, collapsible wheel stand or wheel stand with material shelf. In a carton.

Description	Version/Equipment	Art.-No.
3000 L-T	Universal motor 230 V or 110 V, 50–60 Hz, 1700 W. 23 rpm. Equipment R 2½–3	380303
	Equipment R ½–3	380309
3010 L-T	Pole-reversible capacitor motor 230 V, 50 Hz, 2100 W. 20/10 rpm, also under full load. Extremely quiet running. Equipment R 2½–3	380304
	Equipment R ½–3	380310
3020 L-T	Pole-reversible 3~ induction motor 400 V, 50 Hz, 2000 W. 20/10 rpm, also under full load. Extremely quiet running. Equipment R 2½–3	380305
	Equipment R ½–3	380311
3000 T*	Universal motor 230 V or 110 V, 50–60 Hz, 1700 W. 23 rpm. Equipment R 2½–3	380306
	Equipment R ½–3	380312
3010 T*	Pole-reversible capacitor motor 230 V, 50 Hz, 2100 W. 20/10 rpm, also under full load. Extremely quiet running. Equipment R 2½–3	380307
	Equipment R ½–3	380313
3020 T*	Pole-reversible 3~ induction motor 400 V, 50 Hz, 2000 W. 20/10 rpm, also under full load. Extremely quiet running. Equipment R 2½–3	380308
	Equipment R ½–3	380314

Other voltages and NPT versions on request.

*T versions with REMS roll grooving device for roll grooving can only be used up to DN 200, 8".

Accessories

Description	Art.-No.
Stand	344105
Wheel stand with material shelf	344100
Collapsible wheel stand	344150
Dies see page 40.	
Tool set R ½–2" complete with universal automatic die head 1/16–2", dies for pipe threads, tapered, ISO 7-1, EN 10226 (DIN 2999, BSPT) R ½–¾" and R 1–2" right-hand, pipe cutter, inner pipe deburrer, pressing lever.	340100
Universal automatic die head 1/16–2" and others	341000
Universal automatic die head 2½–3"	381050
Universal automatic die head 2½–4"	381000
Changeover valve , for reversing flow direction of the coolant-lubricant pump for cutting left-handed threads with REMS Magnum 2010, 2020, 3010, 3020, 4010 and 4020	342080
REMS cutter wheel St ½–4", s 8	341614
REMS cutter wheel St 1–4", s 12	381622
Thread-cutting oil see page 49.	
Nipple holder see page 48.	
REMS Herkules material supports, see page 107.	
REMS roll grooving attachment for pipe grooving, see page 50.	347000

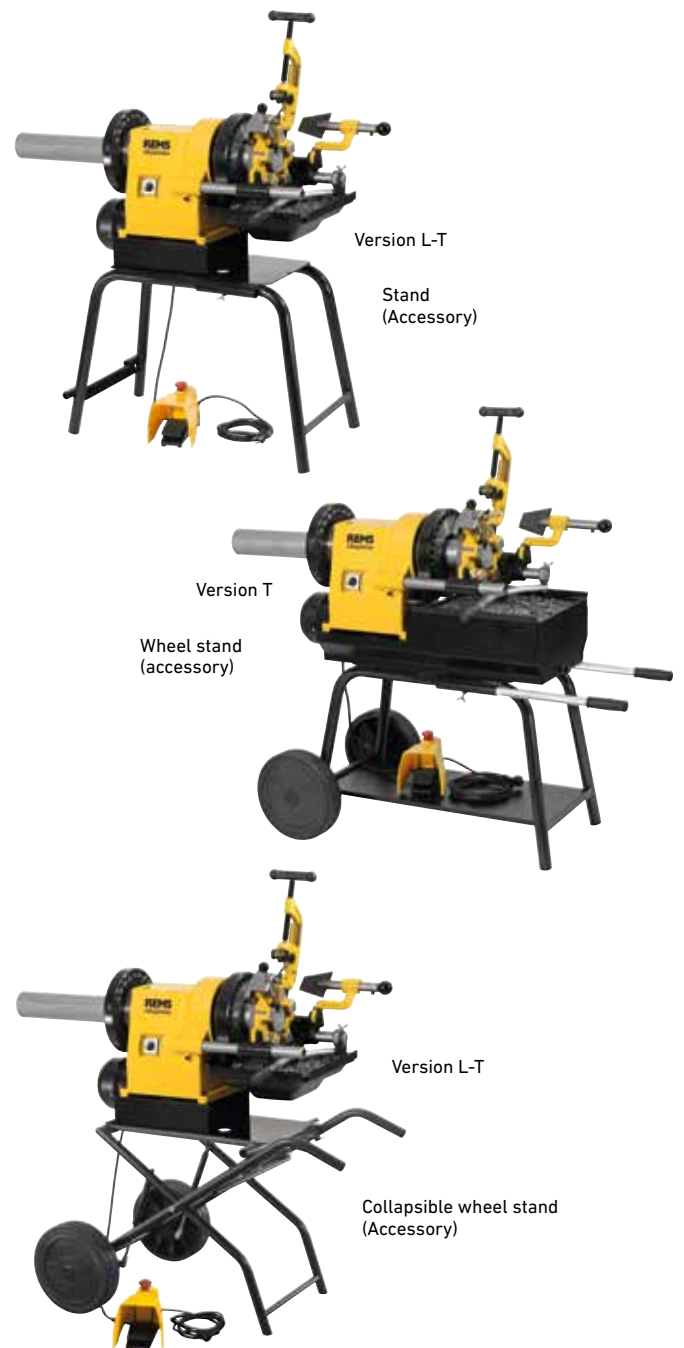

Robust, compact high performance machine for threading, cutting, deburring, threading of nipples, roll grooving. For installation, metalworking, industry. For job site and workshop.

Pipe threads (1/16) 1/2–4", 18–63 mm
Bolt threads (6) 20–60 mm, 1/2–2"

Thread types see page 40.

Pipe grooving with REMS roll grooving attachment DN 25–300
1–12"

REMS Magnum – the super machine up to 4". Exceptionally round and clean threads up to 4" by using 6 threading dies.

Operating principle

Rotating material - stationary tools.

Design

Robust, compact, job site-proven design. Favorable size and weight, e.g. REMS Magnum 4000 L-T only 81 kg. Large work and chip compartment. Tool support.

2 versions:

- Light version L-T with removable large oil basin and chip tray.
 - Version T with integrated, even larger oil basin and chip tray.
- For workbench. Stand, collapsible wheel stand or wheel stand with material shelf, as an accessory, for easy transport, optimum working height and stable positioning.

Drive

Extremely powerful and fast. Completely maintenance-free gear which runs in a sealed oil bath.

Choice of 3 powerful motors:

- Strong universal motor, 1700 W. Overload protection. Spindle speed 23 rpm.
- Pole-reversible capacitor motor, 2100 W. Overload protection. 2 spindle speeds 20 and 10 rpm, also under full load. **Extremely quiet running.**
- Pole-reversible 3~ induction motor, 2000 W. Overload protection. 2 spindle speeds 20 and 10 rpm, also under full load. **Extremely quiet running.**

Operator-friendly safety foot switch with emergency-stop, 2-step. Foot switch, can be loaded with the full body weight during operation.

Chuck

Proven quick-action hammer chuck, self-tightening. No slipping of pipes. Large space between chuck and centering device ensures secure clamping of long pipes. Rear centering device for alignment of the material. Collets are available for clamping pipes $\varnothing 1/2''$ and bolts $\varnothing 18\text{ mm}$.

Automatic lubrication and cooling

Robust, proven oil pump with high pumping volume. Optimized oil distribution directly onto the threading point through the die head ensures clean threads and long service life of dies, gear and motor.

Universal automatic die head

Only 1 universal automatic die head each for the sizes 1/16–2" and 2 1/2–4" for all threads, including long threads; automatic opening with automatic thread-length-stop for tapered threads. 6 dies 2 1/2–4" ensure a favourable distribution of the cutting force onto the pipe, hence round and clean threads. Fast and easy adjustment of thread size. Simple and fast change of dies through lock-in positioning in die holder.

Dies

The proven, indestructible REMS quality dies with precise cutting geometry ensure an excellent start-cutting performance, easy threading and clean threads. Dies in a high-quality special-grade steel, fully tempered and hardened, for extremely long die life.

Pipe cutter

Self centering. Robust body made of forged steel. Ergonomic, wide handle for powerful infeed of spindle. Specially hardened cutter wheel in tough-hard REMS die-steel ensures long service life.

Inner pipe deburrer

Robust, easy-to-handle deburring device for adjustable deburring positioning. Specially hardened and designed deburring blade ensures easy deburring and extremely long service life. Two cutting edges for optimum chip flow, specially for small diameters.

Tool sets

For 2 1/2–4" and 1/2–2" one complete tool set each adapted to the work range with universal die head, pipe cutter, inner-pipe-deburring device, pressing lever, dies.



German Quality Product



Choice of 3 powerful motors.



Thread-cutting oil

REMS Sanitol and REMS Spezial (page 49). Specially developed for threading. High cooling and lubricating effect. Essential for clean threads and longer service life of dies, tools and machines.

Nipple-threading

Efficient with automatic internal clamping REMS Nippelfix ½–4" or with manual internal clamping REMS Nippelspanner ¾–2" (page 48).

REMS roll grooving attachment

Robust, compact roll grooving attachment with oil hydraulic in-feed for pipe grooving of grooved coupling systems DN 25–300, 1–12" (page 50).

Supply format

REMS Magnum. Threading machine for pipe threads (1/16) ½–4", 16–63 mm, bolt threads (6) 18–60 mm, ½–2". With maintenance-free gear, safety foot switch with emergency-stop, self-tightening quick-action hammer chuck, rear centering device, automatic lubrication and cooling. With tool sets 1/16–2" and/or 2 1/2–4", each consisting of universal automatic die head for all threads, also long threads; automatic opening, with automatic thread-length-stop for tapered threads, dies for pipe threads, tapered, ISO 7-1, EN 10226 (DIN 2999, BSPT) R right-hand, pipe cutter, inner pipe deburrer, pressing lever. Tool support. Choice of 3 motors. Version L-T with removable large oil basin and chip tray. Version T with integrated, even larger oil basin and chip tray. For workbench, stand, collapsible wheel stand or wheel stand with material shelf. In a carton.

Description	Version/Equipment	Art.-No.
4000 L-T	Universal motor 230 V or 110 V, 50–60 Hz, 1700 W. 23 rpm.	
	Equipment R ½–2	380447
	Equipment R 2 1/2–4	380441
	Equipment R ½–4	380444
4010 L-T	Pole-reversible capacitor motor 230 V, 50 Hz, 2100 W. 20/10 rpm, also under full load. Extremely quiet running.	
	Equipment R ½–2	380448
	Equipment R 2 1/2–4	380442
	Equipment R ½–4	380445
4020 L-T	Pole-reversible 3~ induction motor 400 V, 50 Hz, 2000 W. 20/10 rpm, also under full load. Extremely quiet running.	
	Equipment R 2 1/2–4	380443
	Equipment R ½–4	380446
4000 T*	Universal motor 230 V or 110 V, 50–60 Hz, 1700 W. 23 rpm.	
	Equipment R 2 1/2–4	380426
	Equipment R ½–4	380429
4010 T*	Pole-reversible capacitor motor 230 V, 50 Hz, 2100 W. 20/10 rpm, also under full load. Extremely quiet running.	
	Equipment R 2 1/2–4	380427
	Equipment R ½–4	380430
4020 T*	Pole-reversible 3~ induction motor 400 V, 50 Hz, 2000 W. 20/10 rpm, also under full load. Extremely quiet running.	
	Equipment R 2 1/2–4	380428
	Equipment R ½–4	380431

Other voltages and NPT versions on request.

*T versions with REMS roll grooving device for roll grooving can only be used up to DN 200, 8".

Accessories

Description	Art.-No.
Stand	344105
Wheel stand with material shelf	344100
Collapsible wheel stand	344150
Dies see page 40.	
Tool set R ½–2" complete with universal automatic die head 1/16–2", dies for pipe threads, tapered, ISO 7-1, EN 10226 (DIN 2999, BSPT) R ½–¾" and R 1–2" right-hand, pipe cutter, inner pipe deburrer, pressing lever.	340100
Universal automatic die head 1/16–2" and others	341000
Universal automatic die head 2 1/2–4"	381000
Changeover valve , for reversing flow direction of the coolant-lubricant pump for cutting left-handed threads with REMS Magnum 2010, 2020, 3010, 3020, 4010 and 4020	342080
REMS cutter wheel St 1/8–4", s 8	341614
REMS cutter wheel St 1–4", s 12	381622
Thread-cutting oil see page 49.	
Nipple holder see page 48.	
REMS Herkules material supports , see page 107.	
REMS roll grooving attachment for pipe grooving, see page 50.	347000



REMS dies (set)

The proven REMS quality dies with precise cutting geometry ensure an excellent start-cutting performance, easy threading and clean threads. Dies in a high-quality special-grade steel, fully tempered and hardened, for materials < 500 N/mm² (MPa) for extremely long die life.

Dies for other threads (e.g. BSW) on request. HSS dies for materials that are difficult to cut ≥ 500 N/mm² (MPa) 50 % surcharge.

¹⁾ Some dies only available in HSS.

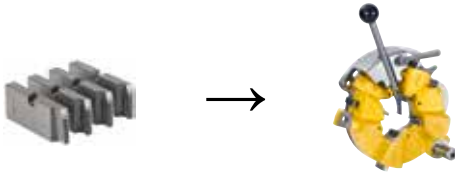

For universal automatic die head 1/16 – 2"

Thread type	Size	Art.-No.
Pipe threads R tapered, right-hand ISO 7-1, EN 10226 (DIN 2999, BSPT)	R 1/16 – 1/8 HSS ¹⁾	341401
	R 1/4 – 3/8	341402
	R 1/2 – 3/4	341403
	R 1 – 2	341404
Pipe threads G parallel, right-hand ISO 228-1 (DIN 259, BSPP)	G 1/16 – 1/8	341406
	G 1/4 – 3/8	341407
	G 1/2 – 3/4	341408
	G 1 – 2	341409
Pipe threads NPT tapered, right-hand Taper Pipe Thread ASME B1.20.1	NPT 1/16 – 1/8 HSS ¹⁾	341411
	NPT 1/4 – 3/8	341412
	NPT 1/2 – 3/4	341413
	NPT 1 – 2	341414
Pipe threads NPSM parallel, right-hand Straight Pipe Thread ASME B1.20.1	NPSM 1/8	341416
	NPSM 1/4 – 3/8	341417
	NPSM 1/2 – 3/4 HSS ¹⁾	341418
	NPSM 1 – 2 HSS ¹⁾	341419
Conduit threads Pg DIN 40430	Pg 7	341466
	Pg 9	341467
	Pg 11	341468
	Pg 13.5	341469
	Pg 16	341470
	Pg 21	341471
	Pg 29	341472
	Pg 36	341473
	Pg 42	341474
	Pg 48	341475
Conduit threads M EN 60423	M 16 × 1.5	341493
	M 20 × 1.5	341494
	M 25 × 1.5	341495
	M 32 × 1.5	341496
	M 40 × 1.5	341497
	M 50 × 1.5	341498
	M 63 × 1.5	341499
Metric bolt threads M ISO 261 (DIN 13)	M 6	341426
	M 8	341427
	M 10	341428
	M 12	341429
	M 14	341430
	M 16	341431
	M 18	341432
	M 20	341433
	M 22	341434
	M 24	341435
	M 27	341436
	M 30	341437
	M 33	341438
	M 36	341439
	M 39	341440
	M 42	341441
	M 45	341442
	M 48	341443
	M 52	341444
	M 56 HSS ¹⁾	341445
M 60 HSS ¹⁾	341446	
Bolt threads UNC Unified Inch Screw Thread ASME B1.1	UNC 1/4 – 20 HSS ¹⁾	341476
	UNC 5/16 – 18	341477
	UNC 3/8 – 16 HSS ¹⁾	341478
	UNC 7/16 – 14	341479
	UNC 1/2 – 13 HSS ¹⁾	341480
	UNC 9/16 – 12	341481
	UNC 5/8 – 11 HSS ¹⁾	341482
	UNC 3/4 – 10 HSS ¹⁾	341483
	UNC 7/8 – 9 HSS ¹⁾	341484
	UNC 1 – 8 HSS ¹⁾	341485
	UNC 1 1/8 – 7	341486
	UNC 1 1/4 – 7 HSS ¹⁾	341487
	UNC 1 3/8 – 6	341488
	UNC 1 1/2 – 6 HSS ¹⁾	341489
	UNC 1 3/4 – 5	341490
UNC 2 – 4.5	341491	

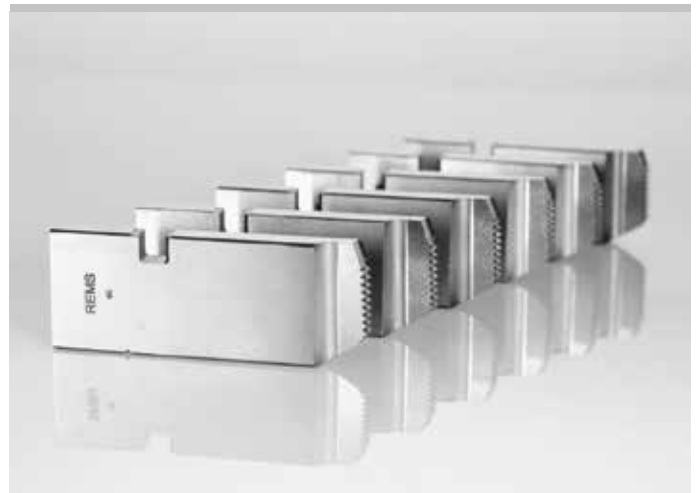

German Quality Product

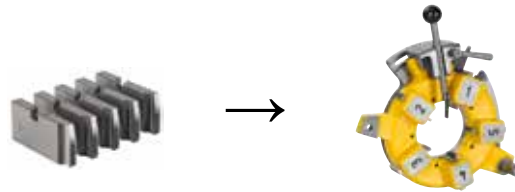

For universal automatic die head 2 1/2 – 3"

Thread type	Size	Art.-No.
Pipe threads R tapered, right-hand ISO 7-1, EN 10226 (DIN 2999, BSPT)	R 2 1/2 – 3	381430
Pipe threads G parallel, right-hand ISO 228-1 (DIN 259, BSPP)	G 2 1/2 – 3 HSS ¹⁾	381431
Pipe threads NPT tapered, right-hand Taper Pipe Thread ASME B1.20.1	NPT 2 1/2 – 3 HSS ¹⁾	381432
Pipe threads NPSM parallel, right-hand Straight Pipe Thread ASME B1.20.1	NPSM 2 1/2 – 3 HSS ¹⁾	381433

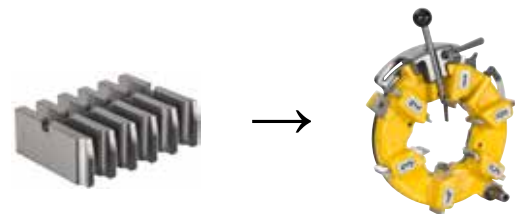

For universal automatic die head 2 1/2 – 4"

Thread type	Size	Art.-No.
Pipe threads R tapered, right-hand ISO 7-1, EN 10226 (DIN 2999, BSPT)	R 2 1/2 – 4	381401
Pipe threads G parallel, right-hand ISO 228-1 (DIN 259, BSPP)	G 2 1/2 – 4 HSS ¹⁾	381405
Pipe threads NPT tapered, right-hand Taper Pipe Thread ASME B1.20.1	NPT 2 1/2 – 4 HSS ¹⁾	381410
Pipe threads NPSM parallel, right-hand Straight Pipe Thread ASME B1.20.1	NPSM 2 1/2 – 4 HSS ¹⁾	381415



REMS
Unimat 77

REMS
Unimat 75

Semi-automatic high-performance machine for efficient cutting of bolt and pipe threads. For industry, metalworking, installation.

Bolt threads	6 – 72 mm 1/4 – 2 3/4"	
Pipe threads	1/16 – 2 1/2", 16 – 63 mm	
Tolerance class corresponding to ISO 261 (DIN 13)	"medium" (6 g)	
Thread length	≤ Ø 30 mm	unlimited
	≤ Ø 72 mm	≤ 200 mm
Chamfering	Range	7 – 62 mm
	Chamfered Ø	≥ 7 mm
	Maximum chamfer	7 mm
	Chamfer angle	45°
Peeling	Range	7 – 62 mm
	Peeled Ø	≥ 7 mm

Thread types see page 44.

REMS Unimat 75 – high efficiency. Tangential-chaser-threading-system. Large threading range. Fast working, short resetting time. For single and series production. Low hourly rate for the machine. Simple operation. Relieves expensive turning machines and specialists.

Operating principle

Stationary material – rotating die head.

Design

Compact, rugged design for continuous use. Die head with regrindable tangential chasers in self centering holder system. After start-cutting with feed lever and rack mechanism self feeding action of die head (no guide thread). Welded, sturdy machine stand with large oil compartment and removeable chip drawer.

Drive

Indestructible planetary gear with annulus gear for long threads up to Ø 30 mm. Proven and powerful pole-reversible three-phase motor, specially designed for threading, with hollow shaft, 2000/2300 W. Overload protection. Reverse switch for cutting right and left-hand threads. High operating speed, 2 spindle speeds 70 and 35 rpm.

Clamping device

Self-centering universal vice for the complete range with specially toothed and hardened clamping jaws. Choice of manual or hydraulic clamping with operation by foot switch (working pressure 6 bar).

Special clamping jaws

For drawn material, stud bolts, hex screws and pipe nipples, as accessory.

Automatic lubrication and cooling

Robust, proven oil pump with high pumping volume. Ample oil volume ensures longer service life of chasers, gear and motor.

Universal automatic die head

Only **one** universal automatic die head for all threads. Fine adjustment of thread diameter with spindle and scale. Die head closes automatically and opens automatically when the required thread length is reached. After starting the thread via feed lever and rack the chaser-system initiates an automatic feed-forward of the die head. All threads can be cut in a single pass. Copying unit for tapered threads. Instead of changing the dies, additional quick-change die heads ensure shorter resetting time.

Chasers

The proven regrindable REMS tangential chasers with precise cutting geometry ensure an excellent start-cutting performance and clean threads. Tool steel chasers made of special hardened steel for material < 500 N/mm² (MPa). HSS chasers for hard-to-machine material ≥ 500 N/mm² (MPa). The chasers sit in a special holder system. Chasers and holders together form a threading set.

Thread cutting on rebar

Special chaser dies M with additional, ground cut for cutting threads on rebar in a single pass. Driven by REMS Unimat 75 with oil-hydraulic/pneumatic vice, for high clamping pressure.



German Quality Product

Machining examples



Info



Thread-cutting oil

REMS Sanitol and REMS Spezial (page 49). Specially developed for threading. High cooling and lubricating effect. Essential for clean threads and longer service life of dies, tools and machines.

Nipple-threading

Efficient with special clamping jaws $\frac{1}{16}$ – $1\frac{1}{4}$ " or with the automatic internal clamping REMS Nippelfix $\frac{1}{2}$ – $2\frac{1}{2}$ " or with the manual internal clamping REMS Nippelspanner $\frac{3}{8}$ – 2 " (page 48).



Supply format

REMS Unimat 75 Basic. Semi-automatic threading machine for bolt threads 6–72 mm, $\frac{1}{4}$ – $2\frac{3}{4}$ ", pipe threads $\frac{1}{16}$ – $2\frac{1}{2}$ ", 16–63 mm. Machine on stand. Pole-reversible 3~ induction motor with hollow shaft, 400 V, 50 Hz, 2000/2300 W, right and left-hand rotation. Die head speed 70 and 35 rpm. Self-centering universal chuck for the complete clamping range, choice of manual or oil-hydraulic/pneumatic operation. Automatic lubrication and cooling. 1 universal automatic die head for all threads, opens and closes automatically. Without threading sets, without closing lever. Electric locking system of safety cover. Adjustment gauge. Wrench. In transport case.

Description	Version	Art.-No.
REMS Unimat 75 Basic mS	manual clamping device	750003
REMS Unimat 75 Basic pS	oil-hydraulic/pneumatic vice clamping device	750004

Other voltages on request.

Accessories

Description	Art.-No.
Chasers and holders (threading sets) and chasers see page 44.	
Universal automatic die head , without threading sets, without closing lever	751000
Closing lever for closing and opening the chasers	
R for taper pipe threads, right-hand	751040
R-L for taper pipe threads, left-hand	751050
G for cylindrical pipe threads, right-hand	751060
G-L for cylindrical pipe threads, left-hand	751070
M for all bolt threads, right-hand	751080
M-L for all bolt threads, left-hand	751090
Chamfering/peeling die head 45°, Ø 7–62 mm , with chamfering/peeling chasers 45°, Ø 7–62 mm, HSS, with holder	751100
Chamfering/peeling die head 45°, Ø 7–62 mm , without threading sets	751102
Chamfering/peeling chasers 45°, Ø 7–46 mm , HSS, with holder	751096
Chamfering/peeling chasers 45°, Ø 40–62 mm , HSS, with holder	751098
Chamfering/peeling chasers 45°, Ø 7–62 mm , pack of 4, with holder	751097
Special clamping jaws, pair , for drawn material, stud bolts and hex screws. Workpiece length protrude from vice without thread, minimum 15 mm, Ø 6–42 mm	753240
Thread-cutting oil see page 49.	
Nipple holder see page 48.	
REMS Herkules material supports , see page 107.	





German Quality Product



German Quality Product

Chasers and holders (threading set)

The proven regrindable REMS tangential chasers with precise cutting geometry ensure an excellent start-cutting performance and clean threads. Tool steel chasers made of special hardened steel for material < 500 N/mm² (MPa). HSS chasers for hard-to-machine material ≥ 500 N/mm² (MPa). The chasers sit in a special holder system. Chasers and holders together form a threading set.

Thread type	Size	Art.-No.
Pipe threads R tapered, right-hand ISO 7-1, EN 10226 (DIN 2999, BSPT)	R 1/16 - 1/8	759250
	R 1/4 - 3/8	759251
	R 1/2 - 3/4	759252
	R 1 - 2	759253
	R 2 1/2	759254
Pipe threads G parallel, right-hand ISO 228-1 (DIN 259, BSPP)	G 1/16 - 1/8	759255
	G 1/4 - 3/8 HSS ¹⁾	759256
	G 1/2 - 3/4 HSS ¹⁾	759257
	G 1 - 2 HSS ¹⁾	759258
	G 2 1/2 HSS ¹⁾	759259
Pipe threads NPT tapered, right-hand Taper Pipe Thread ASME B1. 20.1	NPT 1/16 - 1/8	759360
	NPT 1/4 - 3/8 HSS ¹⁾	759361
	NPT 1/2 - 3/4 HSS ¹⁾	759362
	NPT 1 - 2 HSS ¹⁾	759363
Pipe threads NPSM parallel, right-hand Straight Pipe Thread ASME B1. 20.1	NPSM 1/16 - 1/8	759365
	NPSM 1/4 - 3/8	759366
	NPSM 1/2 - 3/4 HSS ¹⁾	759367
	NPSM 1 - 2 HSS ¹⁾	759368
Conduit threads Pg DIN 40430	Pg 7	759260
	Pg 9 - 16	759261
	Pg 21 - 48	759262
Conduit threads M EN 60423	M 16 - 20 x 1.5	759263
	M 25 - 32 x 1.5	759264
	M 40 - 50 x 1.5	759265
	M 63 x 1.5 HSS ¹⁾	759330
Threads M for rebar ISO 261 (DIN 13)	M 14 - 16 HSS	759274
	M 18 - 22 HSS	759275
	M 24 - 27 HSS	759276
	M 30 - 33 HSS	759277
	M 36 - 39 HSS	759278
	M 42 - 45 HSS	759279
Metric bolt threads M ISO 261 (DIN 13)	M 6 HSS ¹⁾	759270
	M 8	759271
	M 10	759272
	M 12	759273
	M 14 - 16	759274
	M 18 - 22	759275
	M 24 - 27	759276
	M 30 - 33	759277
	M 36 - 39	759278
	M 42 - 45	759279
	M 48 - 52 HSS ¹⁾	759280
	M 56 - 60 HSS ¹⁾	759281
	M 64 - 72 HSS ¹⁾	759282
Bolt threads UNC Unified Inch Screw Thread ASME B1.1	UNC 1/4 - 20	759370
	UNC 5/16 - 18	759371
	UNC 3/8 - 16	759372
	UNC 7/16 - 14	759373
	UNC 1/2 - 13	759374
	UNC 9/16 - 12	759375
	UNC 5/8 - 11	759376
	UNC 3/4 - 10	759377
	UNC 7/8 - 9	759378
	UNC 1 - 8 HSS ¹⁾	759379
	UNC 1 1/8 - 7	759380
	UNC 1 3/8 - 6	759381
	UNC 1 3/4 - 5	759382
	UNC 2 - 2 1/4 - 4.5	759383
	UNC 2 1/2 - 2 3/4 - 4	759384

Dies for other threads (e.g. bicycle threads, fine threads, BSW) and HSS chaser dies for materials above 500 N/mm² (MPa) that are difficult to cut on request. Dies with HSS chaser dies with 50% surcharge on chaser dies. ¹⁾ Some chasers only available in HSS. Threading sets for left-hand threads 50% extra charge on chasers.

Chasers (set)

The proven regrindable REMS tangential chasers with precise cutting geometry ensure an excellent start-cutting performance and clean threads. Tool steel chasers made of special hardened steel for material < 500 N/mm² (MPa). HSS chasers for hard-to-machine material ≥ 500 N/mm² (MPa).

Thread type	Size	Art.-No.
Pipe threads R tapered, right-hand ISO 7-1, EN 10226 (DIN 2999, BSPT)	R 1/16 - 1/8	751501
	R 1/4 - 3/8	751502
	R 1/2 - 3/4	751503
	R 1 - 2 1/2	751504
Pipe threads G parallel, right-hand ISO 228-1 (DIN 259, BSPP)	G 1/16 - 1/8 HSS ¹⁾	751505
	G 1/4 - 3/8	751506
	G 1/2 - 3/4 HSS ¹⁾	751507
	G 1 - 2 1/2 HSS ¹⁾	751508
Pipe threads NPT tapered, right-hand Taper Pipe Thread ASME B1. 20.1	NPT 1/16 - 1/8	751544
	NPT 1/4 - 3/8 HSS ¹⁾	751545
	NPT 1/2 - 3/4 HSS ¹⁾	751546
	NPT 1 - 2 HSS ¹⁾	751547
Pipe threads NPSM parallel, right-hand Straight Pipe Thread ASME B1. 20.1	NPSM 1/16 - 1/8	751549
	NPSM 1/4 - 3/8	751550
	NPSM 1/2 - 3/4 HSS ¹⁾	751551
	NPSM 1 - 2	751552
Conduit threads Pg DIN 40430	Pg 7	751509
	Pg 9 - 16	751510
	Pg 21 - 48	751511
Conduit threads M EN 60423	M 16 - 63 x 1.5 (M 10)	751518
Threads M for rebar ISO 261 (DIN 13)	M 14 - 16 HSS	751520
	M 18 - 22 HSS	751521
	M 24 - 27 HSS	751522
	M 30 - 33 HSS	751523
	M 36 - 39 HSS	751524
	M 42 - 45 HSS	751525
Metric bolt threads M ISO 261 (DIN 13)	M 6	751516
	M 8	751517
	M 10 (M 16 - 63 x 1.5)	751518
	M 12	751519
	M 14 - 16	751520
	M 18 - 22	751521
	M 24 - 27	751522
	M 30 - 33	751523
	M 36 - 39	751524
	M 42 - 45	751525
	M 48 - 52	751526
	M 56 - 60	751527
	M 64 - 72	751528
Bolt threads UNC Unified Inch Screw Thread ASME B1.1	UNC 1/4 - 20	751557
	UNC 5/16 - 18	751558
	UNC 3/8 - 16	751559
	UNC 7/16 - 14	751560
	UNC 1/2 - 13	751561
	UNC 9/16 - 12	751562
	UNC 5/8 - 11	751563
	UNC 3/4 - 10	751564
	UNC 7/8 - 9	751565
	UNC 1 - 8 HSS ¹⁾	751566
	UNC 1 1/8 - 7	751567
	UNC 1 3/8 - 6	751568
	UNC 1 3/4 - 5	751569
UNC 2 - 2 1/4 - 4.5	751570	
UNC 2 1/2 - 2 3/4 - 4	751571	

Chaser dies for other threads (e.g. bicycle threads, fine threads, BSW) and HSS chaser dies for materials above 500 N/mm² (MPa) that are difficult to cut on request. HSS chaser dies with 50% surcharge. ¹⁾ Some chasers only available in HSS. Chasers for left-hand threads 50% extra charge.

Thread tables

Taper Pipe Threads

Whitworth Pipe Thread ISO 7-1, EN 10226 (DIN 2999, BSPT) External thread taper 1:16 Flank angle 55°		
Nominal Size R BSPT	Outside Ø of thread mm	T.P.I.
1/16	7.723	28
1/8	9.728	28
1/4	13.157	19
3/8	16.662	19
1/2	20.955	14
3/4	26.441	14
1	33.249	11
1 1/4	41.910	11
1 1/2	47.803	11
2	59.614	11
2 1/2	75.184	11
3	87.884	11
4	113.030	11

Standard Taper Pipe Thread NPT, ASME B 1.20.1 External thread taper 1:16 Flank angle 60°		
Nominal Size NPT	Outside Ø of thread mm	T.P.I.
1/16	7.938	27
1/8	10.287	27
1/4	13.716	18
3/8	17.145	18
1/2	21.336	14
3/4	26.670	14
1	33.401	11.5
1 1/4	42.164	11.5
1 1/2	48.260	11.5
2	60.325	11.5
2 1/2	73.025	8
3	88.900	8
3 1/2	101.600	8
4	114.300	8

Whitworth Pipe Thread ISO 228-1 (DIN 259, BSPP) External thread parallel Flank angle 55°		
Nominal Size G BSPP	Outside Ø of thread mm	T.P.I.
1/16	7.723	28
1/8	9.728	28
1/4	13.157	19
3/8	16.662	19
1/2	20.955	14
3/4	26.441	14
1	33.249	11
1 1/4	41.910	11
1 1/2	47.803	11
2	59.614	11
2 1/2	75.184	11
3	87.884	11
3 1/2	100.330	11
4	113.030	11

Straight Pipe Thread for Fixtures NPSM, ASME B 1.20.1 External thread parallel Flank angle 60°		
Nominal Size NPSM	Outside Ø of thread mm	T.P.I.
1/8	10.083	27
1/4	13.360	18
3/8	16.815	18
1/2	20.904	14
3/4	26.264	14
1	32.842	11.5
1 1/4	41.605	11.5
1 1/2	47.676	11.5
2	59.715	11.5
2 1/2	72.161	8
3	88.062	8
3 1/2	100.787	8
4	113.436	8

Metric Bolt Thread

Metric ISO Thread ISO 261 (DIN 13) External thread Flank angle 60°		
Nominal Size M	Outside Ø of thread mm	Pitch mm
6	5.974	1
8	7.972	1.25
10	9.968	1.5
12	11.966	1.75
14	13.962	2
16	15.962	2
18	17.958	2.5
20	19.958	2.5
22	21.958	2.5
24	23.952	3
27	26.952	3
30	29.947	3.5
33	32.947	3.5
36	35.940	4
39	38.940	4
42	41.937	4.5
45	44.937	4.5
48	47.929	5
52	51.929	5
56	55.925	5.5
60	59.925	5.5
64	63.920	6
68	67.920	6
72	71.920	6

American and British Bolt Threads

Unified Inch Screw Thread UNC, ASME B 1.1 External thread Flank angle 60°		
Nominal Size UNC	Outside Ø of thread mm	T.P.I.
1/4	6.322	20
5/16	7.907	18
3/8	9.491	16
7/16	11.076	14
1/2	12.661	13
9/16	14.246	12
5/8	15.834	11
3/4	19.004	10
7/8	22.176	9
1	25.349	8
1 1/8	28.519	7
1 1/4	31.694	7
1 3/8	34.864	6
1 1/2	38.039	6
1 3/4	44.381	5
2	50.726	4.5
2 1/4	57.076	4.5
2 1/2	63.421	4
2 3/4	69.768	4

British Standard Parallel Screw Thread of Whitworth Form B.S.W. BS 84 (obsolete): External thread Flank angle 55°		
Nominal Size BSW	Outside Ø of thread mm	T.P.I.
1/4	6.350	20
5/16	7.937	18
3/8	9.525	16
7/16	11.112	14
1/2	12.700	12
5/8	15.875	11
3/4	19.050	10
7/8	22.225	9
1	25.400	8
1 1/8	28.575	7
1 1/4	31.750	7
1 1/2	38.100	6
1 3/4	44.450	5
2	50.800	4.5
2 1/4	57.150	4
2 1/2	63.500	4
2 3/4	69.850	3.5

Threads for Electric Conduit

Conduit Thread DIN 40 430 External thread parallel Flank angle 80°		
Nominal Size Pg	Outside Ø of thread mm	T.P.I.
7	12.5	20
9	15.2	18
11	18.6	18
13.5	20.4	18
16	22.5	18
21	28.3	16
29	37	16
36	47	16
42	54	16
48	59.3	16

Conduit Thread EN 60423 External thread parallel Flank angle 60°		
Nominal Size M	Outside Ø of thread mm	Pitch mm
16	15.968	1.5
20	19.968	1.5
25	24.968	1.5
32	31.968	1.5
40	39.968	1.5
50	49.968	1.5
63	62.968	1.5

Outside diameter of thread is always the maximum diameter, for taper pipe threads this is measured at the scale line.

Semi-automatic high-performance machine for efficient cutting of pipe threads. For industry, metalworking, installation.

Pipe threads	¼ – 4"
Thread length	≤ 120 mm

REMS Unimat 77 – pipe threads up to 4".

Tangential-chaser-threading-system.

Fast working, short resetting time.

For single and series production.

Operating principle

Stationary material – rotating die head.

Design

Compact, rugged design for continuous use. Die head with regrindable tangential chasers in self centering holder system. After start-cutting with feed lever and rack mechanism self feeding action of die head (no guide thread). Welded, sturdy machine stand with large oil compartment and removeable chip drawer.

Drive

Robust worm gear and 2-stage spur gear. Proven and powerful pole-reversible three-phase motor, specially designed for threading. 2000/2300 W. Overload protection. Reverse switch for cutting right and left-hand threads. 4 spindle speeds 50, 25, 16, 8 rpm.

Clamping device

Self-centering universal vice for the complete range of pipe with specially toothed and hardened clamping jaws (¼ – ¾", 1 – 4"). Choice of manual or hydraulic clamping with operation by foot switch (working pressure 6 bar).

Automatic lubrication and cooling

Robust, proven oil pump with high pumping volume. Ample oil volume ensures longer life of chasers, gear and motor.

Universal automatic die head

Only **one** universal automatic die head for all threads. Fine adjustment of thread diameter with spindle and scale. Die head closes automatically and opens automatically when the required thread length is reached. After starting the thread via feed lever and rack the chaser-system initiates an automatic feed-forward of the die head. All threads can be cut in a single pass. Copying unit for tapered threads. Instead of changing the dies, additional quick-change die heads ensure shorter resetting time.

Chasers

The proven regrindable REMS tangential chasers with precise cutting geometry ensure an excellent start-cutting performance and clean threads. Tool steel chasers made of special hardened steel for material < 500 N/mm² (MPa). HSS chasers for hard-to-machine material ≥ 500 N/mm² (MPa). The chasers sit in a special holder system. Chasers and holders together form a threading set.

Thread-cutting oil

REMS Sanitol and REMS Spezial (page 49). Specially developed for threading. High cooling and lubricating effect. Essential for clean threads and longer service life of dies, tools and machines.

Nipple-threading

Efficient with the automatic internal clamping REMS Nippelfix ½ – 4" or with the manual internal clamping REMS Nippelspanner ¾ – 2" (page 48).



German Quality Product

Machining examples



Info





Supply format

REMS Unimat 77 Basic. Semi-automatic threading machine for pipe threads ¼ – 4". Machine on stand. Pole-reversible 3~ induction motor, 400 V, 50 Hz, 2000/2300 W, right and left-hand rotation. Die head speed 50, 25, 16, 8 rpm. Universal vice with clamping jaws 1 – 4", choice of manual or hydraulic/pneumatic operation. Automatic lubrication. 1 universal automatic die head for all threads, opens and closes automatically. Without threading sets, without closing lever. Electrical locking system of safety cover. Adjustment gauge. Wrench. In transport case.

Description	Version	Art.-No.
REMS Unimat 77 Basic mS	manual clamping device	770003
REMS Unimat 77 Basic pS	Oil-hydraulic/pneumatic vice clamping device	770004

Other voltages on request.

Accessories

Chasers and holders (threading set)

Thread type	Size	Art.-No.
Pipe threads R tapered, right-hand ISO 7-1 (EN 10226, DIN 2999, BSPT)	R ¼ – ¾	771110
	R ½ – ¾	771120
	R 1 – 2	771130
	R 2½ – 4	771140
Pipe threads G parallel, right-hand ISO 228-1 (DIN 259, BSPP)	G ¼ – ¾	771160
	G ½ – ¾ HSS ¹⁾	771170
	G 1 – 2 HSS ¹⁾	771180
	G 2½ – 4 HSS ¹⁾	771190
Pipe threads NPT tapered, right-hand Taper Pipe Thread ASME B1.20.1	NPT ¼ – ¾	771210
	NPT ½ – ¾ HSS ¹⁾	771220
	NPT 1 – 2 HSS ¹⁾	771230
	NPT 2½ – 4 HSS ¹⁾	771240
Pipe threads NPSM parallel, right-hand Straight Pipe Thread ASME B1.20.1	NPSM ¼ – ¾	771260
	NPSM ½ – ¾ HSS ¹⁾	771270
	NPSM 1 – 2	771280

Chasers (set)

Thread type	Size	Art.-No.
Pipe threads R tapered, right-hand ISO 7-1 (EN 10226, DIN 2999, BSPT)	R ¼ – ¾	751502
	R ½ – ¾	751503
	R 1 – 4	771136
Pipe threads G parallel, right-hand ISO 228-1 (DIN 259, BSPP)	G ¼ – ¾ HSS ¹⁾	751506
	G ½ – ¾ HSS ¹⁾	751507
	G 1 – 4 HSS ¹⁾	771186
Pipe threads NPT tapered, right-hand Taper Pipe Thread ASME B1.20.1	NPT ¼ – ¾ HSS ¹⁾	751545
	NPT ½ – ¾ HSS ¹⁾	751546
	NPT 1 – 2 HSS ¹⁾	751547
	NPT 2½ – 4 HSS ¹⁾	771246
Pipe threads NPSM parallel, right-hand Straight Pipe Thread ASME B1.20.1	NPSM ¼ – ¾	751550
	NPSM ½ – ¾ HSS ¹⁾	751551
	NPSM 1 – 2	751552

Dies and chaser dies for other threads and HSS chaser dies for materials above 500 N/mm² (MPa) that are difficult to cut on request. Dies and HSS chaser dies with 50% surcharge on chaser dies. ¹⁾Some threading sets and chasers only available in HSS. Threading sets and chasers for left-hand threads 50% extra charge.

Description	Art.-No.
Universal automatic die head, without threading sets, without closing lever	771000
Closing lever for closing and opening the chasers	
R for taper pipe threads, right-hand	751040
R-L for taper pipe threads, left-hand	751050
G for cylindrical pipe threads, right-hand	751060
G-L for cylindrical pipe threads, left-hand	751070
Clamping jaws ¼ – ¾" (pack of 2)	773060

Thread-cutting oil see page 49.

Nipple holder see page 48.

REMS Herkules material supports, see page 107.

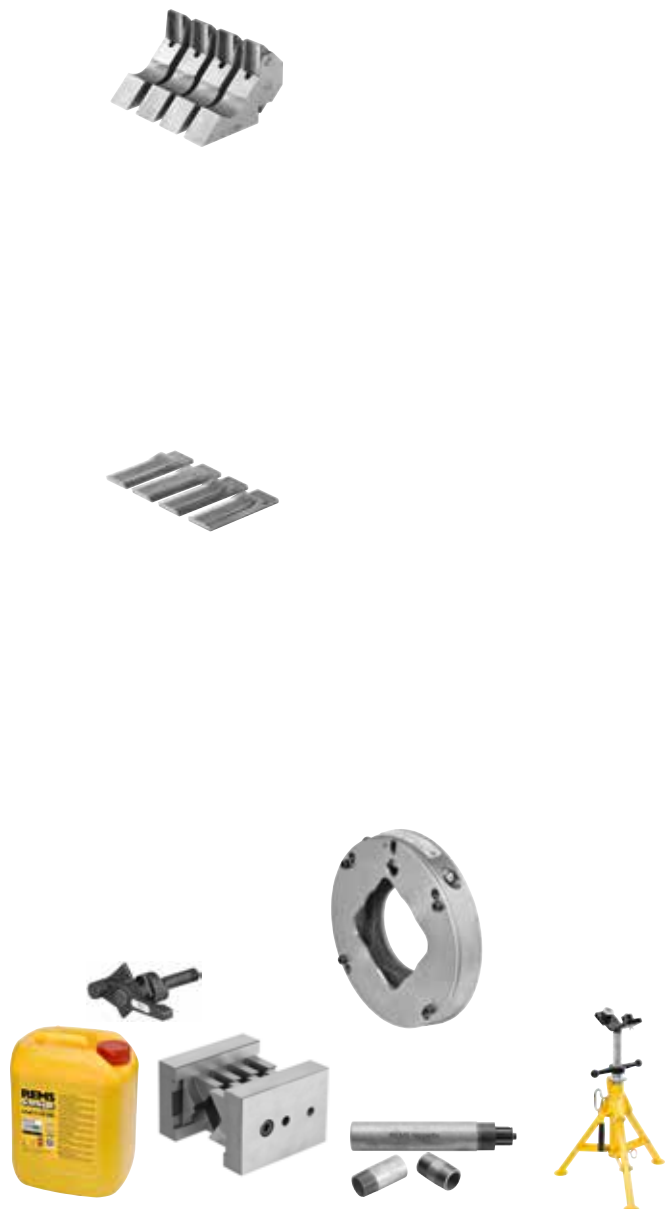

REMS Nippelspanner

Accessories for threading machines and hand die stocks of all types and makes

Manual pipe nipple chuck for internal clamping of short pipe pieces. For universal use.

Nipples and double nipples in standard and special lengths 3/8 – 2"

REMS Nippelspanner – efficient nipple-threading. Any length. Anywhere.

To be used universally for threading machines and for hand die stocks of all types and makes. For opening and non-opening die heads. Ideal accessory for REMS Amigo E, REMS Amigo, REMS Amigo 2, REMS Amigo 2 Compact, REMS Amigo 22V, REMS eva and other makes.

Ideal tool for using up short pipe pieces. Saves time and money.

Chucking and centering of pipe pieces by expanding of specially hardened spring steel segments.

Internal clamping, so no thread required for clamping.

Supply format

REMS Nippelspanner. Manual pipe nipple chuck for internal clamping of short pipe pieces.

Description	Size	Art.-No.
REMS Nippelspanner	3/8"	110000
	1/2"	110100
	3/4"	110200
	1"	110300
	1 1/4"	110400
	1 1/2"	110500
	2"	110600

Supply format

REMS Nippelspanner Set. Manual pipe nipple chuck for internal clamping of short pieces of pipe. In sturdy steel case.

Description	Art.-No.
Set 1/2 + 3/4 + 1 + 1 1/4"	110620
Set 1/2 + 3/4 + 1 + 1 1/4 + 1 1/2 + 2"	110621



German Quality Product



REMS Nippelfix

Accessories for threading machines with opening die head

Automatic pipe nipple chuck for internal clamping of short pipe pieces.

Nipples and double nipples in standard and special lengths 1/2 – 4"

REMS Nippelfix – efficient nipple-threading up to 4". Any length. Anywhere. Automatic internal clamping. Super fast and simple.

For threading machines with opening die head: Pipe turning machines, machines with rotating die head, threading devices.

Ideal tool for using up short pipe pieces. Saves time and money.

Automatic quick-chuck and centering of pipe piece. No tools.

Automatic release after completion of nipple. Production of nipples possible without taking the Nippelfix out of the clamping device.

Internal clamping, so no thread required for clamping.

Specially hardened and ground clamping jaws for fast and safe clamping.

Supply format

REMS Nippelfix. Automatic pipe nipple chuck for internal clamping of short pipe pieces.

Description	Size	Art.-No.
REMS Nippelfix	1/2"	111000
	3/4"	111100
	1"	111200
	1 1/4"	111300
	1 1/2"	111400
	2"	111500
	2 1/2"	111700
	3"	111800
	4"	111900

Supply format

REMS Nippelfix Set. Automatic pipe nipple chuck for internal clamping of short pieces of pipe. In sturdy steel case.

Description	Art.-No.
Set 1/2 + 3/4 + 1 + 1 1/4"	111620
Set 1/2 + 3/4 + 1 + 1 1/4 + 1 1/2 + 2"	111621



German Quality Product



REMS Spezial

Thread-cutting oil

High-alloyed mineral oil based thread-cutting oil.
For all materials.

For drinking water supplies, comply with local regulations! Mineral oil based thread cutting materials are not permitted for drinking water pipes in AUT, CHE, DEU, DNK and FRA for example.

REMS Spezial – high-alloyed mineral based thread-cutting oil, can be washed out with water. High lubricating and cooling effect.

Specially developed for threading. High lubricating and cooling effect. Essential for clean threads, long service life of dies, tools and machines. Can be washed out with water, approved by experts. Also well suited as a cooling lubricant for sawing metals. REMS Spezial spray without CFC's, so ozone-harmless. REMS Spezial squirt bottle without propellants. Refillable.



German Quality Product

Supply format

REMS Spezial. High-alloyed mineral based thread-cutting oil.

Description	Packing	Art.-No.
REMS Spezial	5 l can	140100
	10 l can	140101
	50 l barrel	140103
	600 ml spray	140105
	500 ml squirt bottle	140106

REMS Sanitol

Thread-cutting oil

Synthetic, mineral oil-free thread-cutting oil.
Specially for drinking water supplies. For all materials.

REMS Sanitol – mineral oil-free, ethanol-free. Completely water soluble. High lubricating and cooling effect.

Developed especially for drinking water pipes but also excellently suitable for universal thread cutting. High lubricating and cooling effect. Essential for clean threads, long service life of dies, tools and machines.

Completely water soluble. Mineral oil-free, ethanol-free. Therefore no negative influence on the drinking water in terms of appearance, smell and taste.

Red in colour for flushing control. Perfect corrosion protector.

Viscosity at -10°C: ≤ 250 mPa s (cP). Pumpable to -28°C.

Also well suited as a cooling lubricant for sawing metals.

REMS Sanitol spray without CFC's, so ozone-harmless.

REMS Sanitol squirt bottle without propellants. Refillable.



German Quality Product

Supply format

REMS Sanitol. Synthetic, mineral oil free thread-cutting oil specially for drinking water supplies and for universal use.

Description	Packing	Art.-No.
REMS Sanitol	5 l can	140110
	50 l barrel	140113
	600 ml spray	140115
	500 ml squirt bottle	140116



DW-0201 AS2032



W1.303



7808-649

REMS roll grooving attachment

Roll grooving attachment

Robust, compact roll grooving attachment with oil hydraulic forward feed for grooving pipes of pipe coupling systems. For installation, sprinkler lines, commercial heating, industry and mining. For job site and workshop.

Steel pipes DN 25 – 300
1 – 12"
s ≤ 7.2 mm

Stainless steel pipes, copper, aluminium, PVC pipes

REMS roll grooving attachment – compact – universal. Oil hydraulic pressure cylinder for powerful in-feed of pressure roller.

Design

Compact, job site-proven. Robust metal housing for tough use. Handy, easy to transport, only 26 kg. Oil hydraulic pressure cylinder for powerful in-feed of pressure roller. Pressure build-up with hydraulic hand pump. Individually adjustable groove-depth-stop with fine adjustment, for automatic limitation of groove depth. Built-in ring gauge for automatic groove-depth-stop.

Grooving rollers

The proven REMS grooving rollers with perfectly size-adjusted pressure rollers and counterpressure rollers with well gripping axial knurls guarantee a secure rotation of the pipe and precise grooving. Grooving rollers machined from hardened special steel ensure extremely long service life. 3 pairs of groove rollers (pressure roller, counter-pressure roller) for the whole working range DN 25 – 300, 1 – 12", easy change. Grooving rollers Cu (pressure roller, counterpressure roller) for copper pipe 54 – 159 mm. Groove rollers INOX (pressure roller made of stainless steel, counter-pressure roller made of toughened, specially hardened steel, nickel-plated) for stainless steel pipes 1 – 1½", 2 – 6" and 8 – 12". Grooving rollers for aluminium, PVC pipes on request.

Drive

Only one roll grooving device for REMS Amigo, REMS Amigo 2, REMS Amigo 2 Compact, REMS Tornado and REMS Magnum. Fast, simple assembly. 3-face drive shaft of roll grooving attachment for secure clamping and optimum power transmission. Roll grooving attachments for threading machines of other makes, adjusted to support arm distance, diameter of support arm and spindle axis of the corresponding drive machine, on request.



German Quality Product



Info



Supply format

REMS roll grooving attachment. Roll grooving attachment for grooving pipes of pipe coupling systems DN 25 – 300, 1 – 12". Roll grooving attachment, hydraulic hand pump, built-in ring gauge for automatic groove-depth-stop, 1 pair of groove rollers (pressure roller, counter-pressure roller) 2 – 6", Allen key. For REMS Amigo, REMS Amigo 2, REMS Amigo 2 Compact, REMS Tornado and REMS Magnum or for other thread cutting machine makes. In a carton.

Description	fit onto	Art.-No.
REMS roll grooving attachment	REMS Amigo/ Amigo 2 Compact ¹⁾ REMS Amigo 2 ¹⁾ REMS Tornado ²⁾ REMS Magnum ²⁾	347000
Roll grooving attachment R 300	Ridgid 300	347001

¹⁾ Conversion kit Amigo/Amigo 2/Amigo 2 Compact (Art. No. 347007) required.

Can be used for roll grooving devices manufactured from 2014 onwards.

²⁾ Can only be used for roll grooving up to DN 200, 8" on T versions.

Roll grooving attachments for other makes on request.

Accessories

Description	Art.-No.
Grooving rollers 1 – 1½" (pair), for steel pipes	347030
Grooving rollers INOX 1 – 1½" (pair), for stainless steel pipes	347053
Grooving rollers 2 – 6" (pair), for steel pipes	347035
Grooving rollers INOX 2 – 6" (pair), for stainless steel pipes	347046
Grooving rollers 8 – 12" (set), for steel pipes	347040
Grooving rollers INOX 8 – 12" (pair), for stainless steel pipes	347047
Grooving rollers Cu 54 – 159 (pair) for Cu pipes	347034
Conversion kit Amigo / Amigo 2 / Amigo 2 Compact / Amigo 22V	347007

REMS Herkules material supports, see page 107.



Powerful roll grooving machine for fast, economical grooving of pipes for pipe coupling systems. For installation, sprinkler lines, commercial heating, industry and mining. For job site and workshop.

Steel pipes DN 25 – 300
1 – 12"
s ≤ 7.2 mm

Stainless steel pipes, copper, aluminium, PVC pipes

**REMS Collum – electrical roll grooving up to 12".
Fast and economical feed of the pressure roller
with oil-hydraulic pressure cylinder.**

Design

Robust, compact construction suitable for building sites. Favourable dimensions, favourable weight, roll grooving device with drive machine only 31 kg. For work bench. Stand or wheel stand as an accessory, for easy transport, optimum working height and stable positioning.

Drive

Fast and powerful, e.g. roll grooving of 6" steel pipe with REMS Collum in just 52 s. Sturdy, compact gear, maintenance-free. Robust, powerful 1200 W universal motor (REMS Collum and REMS Collum 2 Compact) or 1700 W universal motor (REMS Collum 2) for intensive use at large dimensions. Safety switch. Foot switch with coupling for ergonomic working as an accessory.

Roll grooving attachment

Compact, job site-proven. Robust metal housing for tough use. Handy, easy to transport, only 26 kg. Oil hydraulic pressure cylinder for powerful in-feed of pressure roller. Pressure build-up with hydraulic hand pump. Built-in ring gauge for automatic groove-depth-stop.

Grooving rollers

The proven REMS grooving rollers with perfectly size-adjusted pressure rollers and counterpressure rollers with well gripping axial knurls guarantee a secure rotation of the pipe and precise grooving. Grooving rollers machined from hardened special steel ensure extremely long service life. 3 pairs of groove rollers (pressure roller, counter-pressure roller) for the whole working range DN 25 – 300, 1 – 12", easy change. Grooving rollers Cu (pressure roller, counterpressure roller) for copper pipe 54 – 159 mm. Groove rollers INOX (pressure roller made of stainless steel, counter-pressure roller made of toughened, specially hardened steel, nickel-plated) for stainless steel pipes 1 – 1½", 2 – 6" and 8 – 12". Grooving rollers for aluminium, PVC pipes on request.

Material support

Extra sturdy REMS Herkules XL 12" material support for roll grooving of pipes up to 12" (page 107).



German Quality Product



Info



Wheel stand (Accessory)

Herkules 3B (Accessory)

Supply format

REMS Collum. Roll grooving attachment for grooving pipes of pipe coupling systems DN 25 – 300, 1 – 12". Roll grooving attachment, hydraulic hand pump, built-in ring gauge for automatic groove-depth-stop, 1 pair of groove rollers (pressure roller, counter-pressure roller) 2 – 6", Allen key. Choice of 3 drive units, with maintenance-free gear, powerful universal motor, safety switch. For workbench, stand or wheel stand. In a carton.

Description	Version	Art.-No.
Collum	Universal motor 230 V, 50 – 60 Hz, 1200 W, overload protection. 29 min ⁻¹	347006
Collum 2	Universal motor 230 V, 50 – 60 Hz, 1700 W. 28 min ⁻¹	347008
Collum 2 Compact	Universal motor 230 V, 50 – 60 Hz, 1200 W, overload protection. 26 min ⁻¹	347009

Other voltages on request.

Accessories

Description	Art.-No.
Stand	849315
Wheel stand	849310
Foot switch with coupling	347010

REMS Herkules material supports, see page 107.

Grooving rollers and other accessories, see page 50.



Powerful, mobile, cordless roll grooving machine for fast, economical grooving of pipes for pipe coupling systems. For installation, sprinkler lines, commercial heating, industry and mining. For job site and workshop. Li-Ion 22V Technology. For battery and corded operation.

Steel pipes	DN 25 – 300 1 – 12" s ≤ 7.2 mm
-------------	--------------------------------------

Stainless steel pipes, copper, aluminium, PVC pipes

REMS Collum 22 V – electrical roll grooving up to 12".
Mobile, fast, economical. Feed of the pressure roller with oil-hydraulic pressure cylinder. Li-Ion 21.6 V, 9.0 Ah battery, for approx. 23 DN 100/4" grooves with one battery charge*.

Design

Compact, robust, building site-compatible, mobile. Convenient dimensions, comfortable weight, cordless roll grooving machine with drive unit just 34 kg. Practical D-shaped handle with soft grip. Machine status check with overload protection of the drive unit against too high currents, with overheating protection by motor temperature monitoring (NTC), with electronic battery charging status check by a 2-coloured green/red LED. For work bench. Stand or wheel stand as an accessory, for easy transport, optimum working height and stable positioning.

Drive

Powerful and fast, e.g. roll grooving of 4" steel pipe in just 77 s. Solid, maintenance-free gear. Powerful battery motor 21.6 V, with high power reserve, 500 W output, for intensive use with large dimensions. High grooving speed 27 – 20 rpm. Safety tip switch.

Battery or mains operation

Li-Ion 22V Technology. Highly resistant Li-Ion 21.6 V batteries with 9.0 Ah capacity for long service life. Light and powerful, for approx. 23 DN 100/4" grooves with one battery charge*. Graduated charging status check by coloured LEDs. Operating temperature range –10 to +60 °C. No memory effect for maximum battery power. Rapid charger 100 – 240 V, 90 W. Rapid charger 100 – 240 V, 290 W, for shorter charging times, as accessory. Voltage supply 220 – 240 V/21.6 V, 40 A output, for mains operation instead of Li-Ion battery 21.6 V, as accessory.

Roll grooving attachment

Compact, job site-proven. Robust metal housing for tough use. Handy, easy to transport, only 26 kg. Oil hydraulic pressure cylinder for powerful in-feed of pressure roller. Pressure build-up with hydraulic hand pump. Built-in ring gauge for automatic groove-depth-stop.

Grooving rollers

The proven REMS grooving rollers with perfectly size-adjusted pressure rollers and counterpressure rollers with well gripping axial knurls guarantee a secure rotation of the pipe and precise grooving. Grooving rollers machined from hardened special steel ensure extremely long service life. 3 pairs of groove rollers (pressure roller, counter-pressure roller) for the whole working range DN 25 – 300, 1 – 12", easy change. Grooving rollers Cu (pressure roller, counterpressure roller) for copper pipe 54 – 159 mm. Groove rollers INOX (pressure roller made of stainless steel, counter-pressure roller made of toughened, specially hardened steel, nickel-plated) for stainless steel pipes 1 – 1½", 2 – 6" and 8 – 12". Grooving rollers for aluminium, PVC pipes on request.

Material support

Extra sturdy REMS Herkules XL 12" material support for roll grooving of pipes up to 12" (page 107).



German Quality Product



Info





Wheel stand (Accessory)

Herkules 3B (Accessory)



Stand (Accessory)

Herkules XL 12" (Accessory)



Supply format

REMS Collum 22V. Cordless roll grooving machine for grooving pipes for DN 25–300, 1–12" pipe coupling systems. Roll grooving attachment, hydraulic hand pump, built-in ring gauge for automatic groove-depth-stop, 1 pair of groove rollers (pressure roller, counter-pressure roller) 2–6", Allen key. Drive unit with maintenance-free gear, powerful battery motor 21.6V, 500 W. Safety switch. Right and left-hand rotation, machine status check with overload protection, temperature monitoring, battery charging status check. Universal support. Li-Ion 21.6V, 9.0Ah battery, 100–240V, 50–60 Hz, 90W rapid charger. For workbench, stand or wheel stand. In a carton.

	Art.-No.
	347005

Other voltages on request.

Accessories

Description	Art.-No.
REMS Amigo 22V drive unit, without battery	530004
Battery Li-Ion 21.6V, 9.0Ah	571583
Rapid charger 100–240V, 50–60 Hz, 90W	571585
Rapid charger 100–240V, 50–60 Hz, 290W	571587
Voltage supply 220–240V/21.6V, 50–60 Hz, 40A, for mains operation instead of battery Li-Ion 21.6V	571578
Stand	849315
Wheel stand	849310

REMS Herkules material supports, see page 107.

Grooving rollers and other accessories, see page 50.

REMS Lumen 2800 22V, cordless LED flood light, see page 111



* Ambient temperature approx. 20°C.

Robust, compact high performance machine with roll grooving attachment for pipe grooving of pipe coupling systems. For installation, sprinkler lines, commercial heating lines, industry and mining.
For job site and workshop.

Steel pipes	DN 25 – 300 1 – 12" s ≤ 7.2 mm
-------------	--------------------------------------

Stainless steel pipes, copper, aluminium, PVC pipes

Pipe threads 1/8" – 2", 16 – 63 mm, bolt threads 6 – 60 mm, 1/4" – 2", with conversion kit.

REMS Magnum RG – the compact up to 12". Immensely powerful and extremely fast. Feed of the pressure roller with oil-hydraulic pressure cylinder.

Design

Robust, compact, job site-proven design. Favorable size and weight, e.g. REMS Magnum 2000 RG-T only 68 kg. Tool support. For workbench. Stand, collapsible wheel stand or wheel stand with material shelf, as an accessory, for easy transport, optimum working height and stable positioning.

Drive

Immensely powerful and fast, e.g. roll grooving of 6" steel pipe with REMS Magnum 2010 RG-T in just 40 s. Completely maintenance-free gear which runs in a sealed oil bath. Choice of 3 powerful motors (see REMS Magnum page 34). Operator-friendly safety foot switch with emergency-stop, 2-step, can be loaded with the full body weight during operation.

Roll grooving attachment

Compact, job site-proven. Robust metal housing for tough use. Handy, easy to transport, only 26 kg. Oil hydraulic pressure cylinder for powerful in-feed of pressure roller. Pressure build-up with hydraulic hand pump. Built-in ring gauge for automatic groove-depth-stop.

Grooving rollers

The proven REMS grooving rollers with perfectly size-adjusted pressure rollers and counterpressure rollers with well gripping axial knurls guarantee a secure rotation of the pipe and precise grooving. Grooving rollers machined from hardened special steel ensure extremely long service life. 3 pairs of groove rollers (pressure roller, counter-pressure roller) for the whole working range DN 25 – 300, 1 – 12", easy change. Grooving rollers Cu (pressure roller, counterpressure roller) for copper pipe 54 – 159 mm. Groove rollers INOX (pressure roller made of stainless steel, counter-pressure roller made of toughened, specially hardened steel, nickel-plated) for stainless steel pipes 1 – 1 1/2", 2 – 6" and 8 – 12". Grooving rollers for aluminium, PVC pipes on request.

Conversion kit for threading

Tool set 1/4" – 2" complete with universal automatic die head, dies for pipe threads, tapered, ISO 7-1 (DIN 2999, BSPT) R 1/2" – 3/4" and R 1 – 2" right-hand, pipe cutter, inner pipe deburrer, pressing lever, pump for automatic oiling, oil basin, chip tray.

Material support

Extra sturdy REMS Herkules XL 12" material support for roll grooving of pipes up to 12" (page 107).



German Quality Product



Info



Stand
(Accessory)



Wheel stand (Accessory)

Herkules 3B (Accessory)

Supply format

REMS Magnum RG. Roll grooving machine for pipe grooving of pipe coupling systems DN 25–300, 1–12". With maintenance-free gear, safety foot switch with emergency-stop, self-tightening quick-action hammer chuck, rear centering device, automatic lubrication and cooling, tool support. Choice of 3 motors. Roll grooving attachment, hydraulic hand pump, built-in ring gauge with automatic groove-depth-stop, 1 set of grooving rollers (pressure roller, counterpressure roller) 2–6", hexagon key. For workbench, stand, collapsible wheel stand or wheel stand with material shelf. In a carton.

Description	Version	Art.-No.
2000 RG-T	Universal motor 230 V or 110 V, 50–60 Hz, 1700 W. 53 rpm.	340230
2010 RG-T	Pole-reversible capacitor motor 230 V, 50 Hz, 2100 W. 52/26 rpm, also under full load. Extremely quiet running.	340231
2020 RG-T	Pole-reversible 3~ induction motor 400 V, 50 Hz, 2000 W. 52/26 rpm, also under full load. Extremely quiet running.	340232

Other voltages on request.

Accessories

Description	Art.-No.
Stand	344105
Wheel stand with material support	344100
Collapsible wheel stand	344150
REMS Herkules material supports, see page 107.	
Grooving rollers and other accessories, see page 50.	
Conversion kit Magnum RG-T to L-T for threading.	340110











Collapsible wheel stand (Accessory)





Sawing

	Universal electric reciprocating saws	60
	Cordless universal reciprocating saw	62
	Electric reciprocating pipe saws	64
	Pneumatic reciprocating pipe saw	66
	Cordless pipe reciprocating saw	68
	Saw blades for reciprocating saws	70
	Circular pipe sawing machine	72
	Universal circular metal sawing machine	73



Aggressive orbital action by vertical hacking motion of saw blade provides forceful, fast forward feed, excellent chip flow and long service life of saw blades.

Fixed orbital action, running in needle bearings, ensures long-lasting and forceful sawing also during extreme load conditions, e.g. sawing of steel pipe. Adjustable mechanisms with a great variety of parts and a reduced system stability do not withstand the high in-feed pressure and the heavy-duty requirements of forceful cutting of steel pipes, particularly when a guide support with leverage is being used.



Sturdy, square lift rod in special solid steel, mounted precisely in needle bearings towards the force direction and along the complete stroke length, for distortion-free, precise cutting also during tough use and by applying multiple sawing force, e.g. using a guide support with leverage. For extremely long service life.

Special high sliding silicone gasket protects gear against water and dust.



ANC

Super stable, water and dust resistant, maintenance-free oscillating gear enables a simultaneous generation of saw and orbital stroke of lift rod and saw blade. Allround needle bearing mounted crank drive (ANC) reduces friction, heat generation, wear. Thus long service life also at extreme sawing.

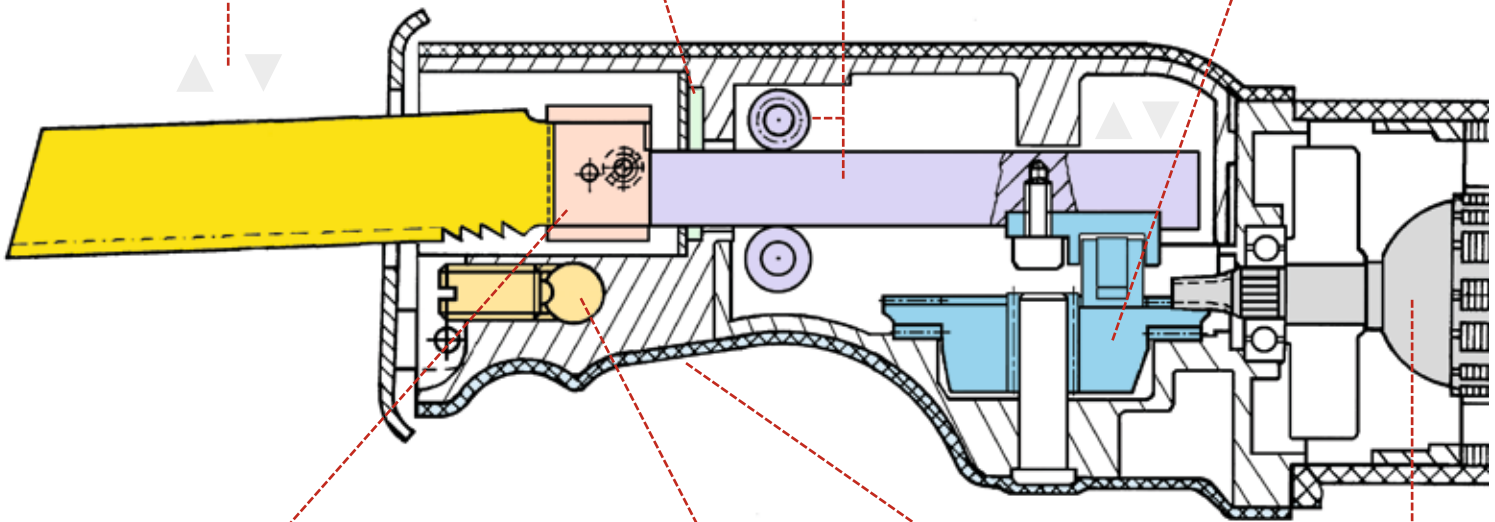

Universal saw blade clamp for mounting all saw blades – with universal or double tang – without changing or turning the saw blade thrust piece.



Guide support for 400 % additional sawing force for fast, effortless sawing. Also for effortless demolition work.

V/bar
Drive motors
230 V, 110 V, 48 V,
22 V, 6 bar

Ergonomically shaped front housing grip with slip resistant protection cover, for forceful feed forward while sawing free-hand.



Vario-Electronic

Electronic stepless speed control of drive unit for sensitive start-sawing and for stroke selection during sawing according to the material. The stroke speed is controlled continuously by variable pressure on the touch switch from 0 to 2,800 rpm (REMS Puma VE), 0 to 2,400 rpm (REMS Cat VE, REMS Tiger VE) or 0 to 1,900 rpm (REMS Cat 22V VE, REMS Tiger 22V VE) (accelerator switch).



Ideal speed

Deliberately fixed speed. Therefore optimum cutting speed for maximum protection of motor and gear and maximum service life of saw blades.

The ideal cutting speed of 2,400 rpm has been determined by extensive sawing tests with steel pipe which lead to optimum performance in combination with the aggressive, fixed orbital action, guide support and REMS special saw blade.



Power-transferring guide support

For assembly and dismantling. Guide support with five-fold force transmitting leverage allows effortless, fast, right angled sawing anywhere on site, without a vice. Ideal handling, easy and rapid to operate, positioned with one hand only for chucking and sawing. No loose swinging chain and cumbersome handling as with chain vice. No danger of jamming by limitation of swing angle. 400% additional sawing force for effortless, super fast sawing during assembly and dismantling, e.g. 2" steel pipe in only 8 s. Straight machine handle for optimum forward feed.



Speed-Regulation

Stepless electronic speed control of drive unit for selecting the speed according to the material. Ideal for sawing stainless steel pipe, cast pipe and for sawing boilers, tanks, bath tubs etc. The speed is continuously adjustable between 700 and 2,200 rpm on the dial. The electronic speed control which is being used keeps the selected speed constant, also under load, including speed generator, control electronics, residual current limitation for sensitive start-sawing, motor temperature control of field wires with PTC resistance (Positive Temperature Coefficient) and stall protection of gear and motor.



Weight

High sawing efficiency at low weight by innovative, proven technology and perfect tuning of all components. For effortless, fatigue-free sawing and easy handling.



Power

All power data stated to be understood as the rated power input. The drive motors of REMS reciprocating saws have a very high efficiency of approx. 65% thanks to an outstanding technology and quality. Therefore the user has a high power output available which is useful particularly for sawing difficult-to-cut materials, e.g. steel pipe. High power output can only be used fully by levered sawing, e.g. with the REMS guide support.



Drive Motors

Depending on model universal motors of voltages of 230 V, 110 V, 48 V, battery motors 22 V or pneumatic motors for 6 bar operating pressures are used. All drive motors are extremely powerful, fulfill highest quality demands and come with large power reserves, for long service life.



Saw blade holder with quick-change system

Practical saw blade holder with quick-change system for fast saw blade changing without tools. For holding single tang saw blades.



Continuously adjustable support shoe

Swivel support shoe for safe guiding of the saw on the material to be sawn. Support shoe continuously adjustable in longitudinal direction by 40 mm for better utilisation of partially blunted saw blades and for setting the plunge-in depth of the saw blade in the material.



Anti-vibration system

Special drive technology with mass compensation and vibration damping handles. For low vibration, effortless sawing.



Saw blade can be inserted turned 180°.

Saw blade can be inserted with the teeth facing down or turned 180° facing up for cuts in confined spaces with difficult access.

Powerful power tool for universal free-hand sawing. Only 3.8 kg. Ideal for assembly, disassembly, repair.

Many materials, e.g. wood, wood with nails, pallets, metal, even stainless steel, cast iron, breeze blocks, plaster boards, pumice stone, brick

REMS Puma VE – the powerful universal saw with anti-vibration system. Quick saw blade change without tools. Adjustable support shoe.

Universal use

Can be used anywhere, free hand, over head, in tight corners, flush with the wall. Extremely versatile and powerful. For all sawing work on the building site and for rescue and emergency operations. Also for plunge-cut sawing.

Design

Powerful, suitable for building sites. Handy, easy grip shape. Only 3.8 kg. Ergonomically designed front housing grip with non-slip, heat insulating protective jacket with soft grip, for powerful sawing thrust. Practical D-shaped handle with vibration damping soft grip. Drive rod runs in an enclosed drive housing for safe work. Large saw blade stroke, 30 mm, for better cut clearance. Fast stroke speed up to 2,800 rpm for fast sawing thrust and effective sawing. Robust crank drive, maintenance-free. High sliding special seal. Powerful, high capacity universal motor with large power reserve, 1,300 W, safety switch. 4 m long connecting lead. Safety switch.

Anti-vibration system

Special drive technology with mass compensation and vibration damping handles. For low vibration, effortless sawing.

Vario-Electronic

Continuous electronic stroke speed control for gentle start of sawing and selection of a stroke speed suitable for the material. The stroke speed can be continuously controlled by variable pressure on the safety switch from 0 to 2,800 rpm (accelerator switch).

Saw blade holder with quick-change system

Practical saw blade holder with quick-change system for fast saw blade changing without tools. For holding single tang saw blades. Saw blade can be inserted with the teeth facing down or turned 180° facing up for cuts in confined spaces with difficult access.

REMS saw blades

Full range of REMS saw blades for free-hand sawing of different materials (page 71).

Continuously adjustable support shoe

Swivel support shoe for safe guiding of the saw on the material to be sawn. Support shoe continuously adjustable in longitudinal direction by 40 mm for better utilisation of partially blunted saw blades and for setting the plunge-in depth of the saw blade in the material. For economical working.

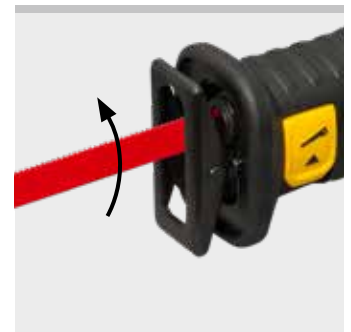

Info

Supply format

REMS Puma VE Set. Electric universal reciprocating saw with Vario-Electronic (VE) for free-hand sawing, with anti-vibration system. Drive machine with D-shaped handle with soft grip, maintenance-free crank drive, powerful 230 V, 50–60 Hz, 1,300 W universal motor, safety switch, connecting cable 4 m. Continuous electronic stroke speed control (accelerator switch) 0 to 2,800 rpm. 30 mm stroke. Saw blade holder with quick-change system Adjustable support shoe. Hexagon key, 1 REMS saw blade 210-1.8/2.5. In sturdy steel case.

	Art.-No.	
	560023	

Other voltages on request.

Accessories

Description	Art.-No.	
REMS Puma VE drive unit	560003	
REMS saw blades see page 71.		
Steel case	566051	

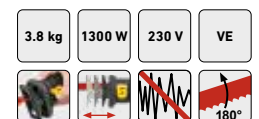

REMS Cat VE

Universal electric reciprocating saw

Powerful, robust, handy power tool for universal free-hand sawing. Only 3.0 kg. Ideal for assembly, dismantling, repair.

Many materials, e.g. wood, wood with nails, pallets, metal, even stainless steel, cast iron, breeze blocks, plaster boards, pumice stone, brick

Especially also for steel pipes

REMS Cat VE – saws anything, anywhere.

Extremely versatile and powerful.

Robust and handy.

Universal use

Ready for use anywhere, free-hand, overhead, in confined areas, flush to wall. Extremely versatile and efficient. Especially also for sawing metal pipes, sawing up boilers, tanks, bath tubs. For rescue and emergency operations. Also for plunge-cut sawing.

Design

Robust, job site-proven. Slender, handy design. Super light, only 3.0 kg. Ergonomically shaped front housing grip with slip resistant, heat insulating protection cover with soft grip, for forceful feed forward. Proven D-shaped handle. Swivel support shoe for safe guiding of the saw on the material to be sawn. High sliding silicone gasket protects gear against water and dust. Powerful universal motor with ample reserve capacity, 1050 W. Safety tip switch.

Sturdy, square lift rod

In special solid steel, mounted precisely in needle bearings towards the force direction and along the complete stroke length, for distortion-free, precise cutting also during tough use. For extremely long service life. Drive rod runs in an enclosed housing for safe work.

Oscillating drive with ANC

Super stable, water and dust resistant, maintenance-free oscillating drive for simultaneous generation of sawing stroke and orbital action of lift rod and saw blade. Allround needle bearing mounted crank drive (ANC) reduces friction, heat generation, wear. For long service life of drive also at extreme sawing.

Aggressive orbital action

Aggressive orbital action by vertical hacking motion of saw blade provides forceful, fast forward feed, excellent chip flow and long service life of saw blades. Fixed orbital action, running in needle bearings, ensures long-lasting and forceful sawing also during extreme load conditions, e.g. sawing of steel pipe.

Vario-Electronic

Electronic stepless speed control of drive unit for sensitive start sawing and for speed selection during sawing. The speed is controlled by pressing the tip switch steplessly from 0 to 2,400 rpm (acceleration switch).

Universal saw blade clamp

All saw blades – with universal or double tang – can be clamped without changing or turning the saw blade thrust piece.

REMS universal saw blade

Only 1 REMS universal saw blade (page 70) for all sawing work instead of many different saw blades. Double tang for free-hand sawing and sawing with guide holder.

REMS saw blades

Full range of REMS saw blades for free-hand sawing of different materials (page 71).



ANC

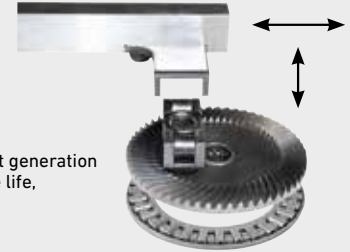

- reduced friction and wear
- substantially reduced heat generation
- for extremely long service life, also during tough use



German Quality Product



Info

Supply format

REMS Cat VE Set. Electric universal reciprocating saw with Vario-Electronic (VE) for free-hand sawing. Drive unit with D-shaped handle, maintenance-free, water and dust resistant oscillating drive with allround needle bearing mounted crank drive (ANC), aggressive orbital action, powerful universal motor 230 V or 110 V, 50–60 Hz, 1050 W, safety tip switch. Electronic stepless speed control (acceleration switch) 0 to 2,400 rpm. Universal saw blade clamp. Hexagon key. 1 REMS universal saw blade 150-1.8/2.5. In sturdy steel case.

	Art.-No.
	560040

Other voltages on request.

Accessories

Description	Art.-No.
REMS Cat VE drive unit	560004
REMS saw blades see page 70 – 71.	
Steel case	566005



REMS Cat 22V VE

Cordless universal reciprocating saw

Powerful, mobile, handy power tool for universal free-hand sawing. Only 3.1 kg. Ideal for assembly, dismantling, repair. Li-Ion 22V Technology. For battery and corded operation.

Many materials, e.g. wood, wood with nails, pallets, metal, even stainless steel, cast iron, breeze blocks, plaster boards, pumice stone, brick

Especially also for steel pipes

REMS Cat 22V VE – saws anything, anywhere. Mobile, handy, light. Li-Ion 21.6V, 5.0 Ah battery, for approx. 75 1" steel pipe cuts with one battery charge*.

Universal use

Ready for use anywhere, free-hand, overhead, in confined areas, flush to wall. Mains independent. Extremely versatile and efficient, particularly for metal. Saws metal pipes, boilers, tanks, bath tubs, window frames, etc., for rescue and disaster service operations. Also for plunge-cut sawing.

Design

Robust, job site-proven. Mobile, handy, light. Drive unit with battery pack weighs only 3.1 kg. Slim form. Ergonomically shaped front housing grip with slip resistant, heat insulating protection cover with soft grip, for forceful feed forward. Practical D-shaped handle with soft grip. Swivel support shoe for safe guiding of the saw on the material to be sawn. High sliding silicone gasket protects gear against water and dust. Powerful 21.6 V battery motor with ample reserve capacity, 500 W output. Safety tip switch. Machine status check with overload protection of the drive unit against too high currents, with overheating protection by motor temperature monitoring (NTC), with electronic battery charging status check with charging level indication by a 2-coloured green/red LED.

Sturdy, square lift rod

In special solid steel, mounted precisely in needle bearings towards the force direction and along the complete stroke length, for distortion-free, precise cutting also during tough use. For extremely long service life.

Oscillating drive with ANC

Super stable, water and dust resistant, maintenance-free oscillating drive for simultaneous generation of sawing stroke and orbital action of lift rod and saw blade. Allround needle bearing mounted crank drive (ANC) reduces friction, heat generation, wear. For long service life of drive also at extreme sawing.

Vario-Electronic

Electronic stepless speed control of drive unit for sensitive start sawing and for speed selection during sawing. The speed is controlled by pressing the tip switch steplessly from 0 to 1,900 rpm (acceleration switch).

Aggressive orbital action

Aggressive orbital action by vertical hacking motion of saw blade provides forceful, fast forward feed, excellent chip flow and long service life of saw blades. Fixed orbital action, running in needle bearings, ensures long-lasting and forceful sawing also during extreme load conditions, e.g. sawing of steel pipe.

Battery or mains operation

Li-Ion 22V Technology. Highly resistant Li-Ion 21.6V battery with 4.4, 5.0 or 9.0 Ah capacity, for long service life. Light and powerful. Li-Ion 21.6V, 4.4 Ah battery, for approx. 66 1" steel pipe cuts, 5.0 Ah battery, for approx. 75 1" steel pipe cuts, 9.0 Ah for approx. 140 1" steel pipe cuts with one battery charge*. Graduated charging status check by coloured LEDs. Operating temperature range – 10 to + 60 °C. No memory effect for maximum battery power. Rapid charger 100–240V, 90W. Rapid charger 100–240V, 290W, for shorter charging times, as accessory. Voltage supply 220–240V/21.6V, 40 A output, for mains operation instead of Li-Ion battery 21.6 V, as accessory.

Universal saw blade clamp

All saw blades – with universal or double tang – can be clamped without changing or turning the saw blade thrust piece.

REMS universal saw blade

Only 1 REMS universal saw blade (page 70) for all sawing work instead of many different saw blades. Double tang for free-hand sawing and sawing with guide holder.

REMS saw blades

Full range of REMS saw blades for free-hand sawing of different materials (page 71).



German Quality Product



Supply format

REMS Cat 22V VE Set. Battery driven universal reciprocating saw with Vario-Electronic (VE) for free-hand sawing. Drive unit with D-shaped handle, maintenance-free, water and dust resistant oscillating drive with allround needle bearing mounted crank drive (ANC), aggressive orbital action, powerful 21.6 V battery motor, safety tip switch. Electronic stepless speed control (acceleration switch) 0 to 1,900 rpm. Machine status check with overload protection, temperature monitoring, battery charging status check. Li-Ion 21.6V, 5.0Ah battery, 100–240V, 50–60 Hz, 90W rapid charger. Universal saw blade clamp. Hexagon key. 1 pcs REMS universal saw blade 150-1.8/2.5. In sturdy steel case.

	Art.-No.
	560052

Other voltages on request.

Accessories

Description	Art.-No.
REMS saw blades see page 70–71.	
REMS Cat 22V VE drive unit, without battery	560010
Battery Li-Ion 21.6V, 4.4 Ah	571574
Battery Li-Ion 21.6V, 5.0 Ah	571581
Battery Li-Ion 21.6V, 9.0 Ah	571583
Rapid charger 100–240V, 50–60 Hz, 90W	571585
Rapid charger 100–240V, 50–60 Hz, 290W	571587
Voltage supply 220–240V/21.6V, 50–60 Hz, 40A, for mains operation instead of battery Li-Ion 21.6V	571578
Steel case with inlay	566030
REMS Lumen 2800 22V, cordless LED flood light, see page 111	



* Ambient temperature approx. 20°C.

Powerful, robust, handy power tool with force-transmitting guide holder for effortless, fast, right-angled sawing everywhere on site, without a vice. Also for universal free-hand sawing. Only 3.0 kg. Ideal for assembly, dismantling, repair.

Ideal for steel pipes and others.

Many materials, e.g. wood, wood with nails, pallets, metal, even stainless steel, cast iron, breeze blocks, plaster boards, pumice stone, brick

For materials that are difficult to cut, e.g. stainless steel pipes, hard cast iron, use the REMS Tiger SR with electronic stroke speed control.

REMS Tiger – the saw for the pipe fitter.

Saws effortlessly, fast, right angle.

Robust and handy.

Power-transferring guide support

400% additional sawing force for effortless, super fast sawing, e.g. 2" steel pipe in only 8 s. For assembly and dismantling. Guide support with five-fold force transmitting leverage allows effortless, fast, right angled sawing anywhere on site, without a vice. Ideal handling, easy and rapid to operate, positioned with one hand only for chucking and sawing. No loose swinging chain and cumbersome handling as with chain vice. No danger of jamming by limitation of swing angle. For optimum in-feed with guide support a straight machine handle is advantageous.

Right angle sawing

Right angle cut thanks to REMS guide support and REMS special saw blade. Essential for subsequent operations in pipe installation.

REMS special saw blade

REMS special saw blade (page 70), extra thick, rigid and unbendable, double tang, absolutely essential for right-angled sawing and fast disassembly of steel pipes with force-transmitting guide holder.

REMS universal saw blade

Only 1 REMS universal saw blade (page 70) for all sawing work instead of many different saw blades. Double tang for free-hand sawing and sawing with guide holder.

REMS saw blades

Full range of REMS saw blades for free-hand sawing of different materials (page 71).

Universal saw blade clamp

All saw blades – with universal or double tang – can be clamped without changing or turning the saw blade thrust piece.

Design

Robust, job site-proven. Slender, handy design. Super light, only 3.0 kg. Can be used anywhere. Ergonomically shaped front housing grip with slip resistant protection cover for forceful feed forward during free-hand sawing. Choice of practical D-shaped handle, advantageous during free-hand sawing, or straight machine handle, advantageous during sawing with guide support. Swivel support shoe for safe guiding of the saw on the material to be sawn. High sliding silicone gasket protects gear against water and dust. Powerful universal motor with ample reserve capacity, 1050 W respectively 1400 W (REMS Tiger SR). Safety tip switch. Choice of drive unit with fixed, ideal speed, electronic speed control (Vario-Electronic) or electronic speed regulation. Overload protection (REMS Tiger) protects motor, gear and saw blade. The electronic tachometer speed controller (REMS Tiger SR) used for control keeps the preselected number of strokes constant even under load and includes tachogenerator, electronic control, start-up current limiter for soft start-up, overheating protection by temperature monitoring of the field winding of the motor with PTC resistance (Positive Temperature Coefficient) and blocking protection for gearbox and motor.

Sturdy, square lift rod

In special solid steel, mounted precisely in needle bearings towards the force direction and along the complete stroke length, for distortion-free, precise cutting also during tough use. For extremely long service life. Drive rod runs in an enclosed housing for safe work.

Oscillating drive with ANC

Super stable, water and dust resistant, maintenance-free oscillating drive for simultaneous generation of sawing stroke and orbital action of lift rod and saw blade. Allround needle bearing mounted crank drive (ANC) reduces friction, heat generation, wear. For long service life of drive also at extreme sawing.

Aggressive orbital action

Aggressive orbital action by vertical hacking motion of saw blade provides forceful, fast forward feed, excellent chip flow and long service life of saw blades. Fixed orbital action, running in needle bearings, ensures long-lasting and forceful sawing also during extreme load conditions, e.g. sawing of steel pipe. Adjustable mechanisms with a great variety of parts and a reduced system stability do not withstand the high feed forward pressure and the heavy-duty requirements of forceful cutting of steel pipes, particularly when a guide support with leverage is being used.

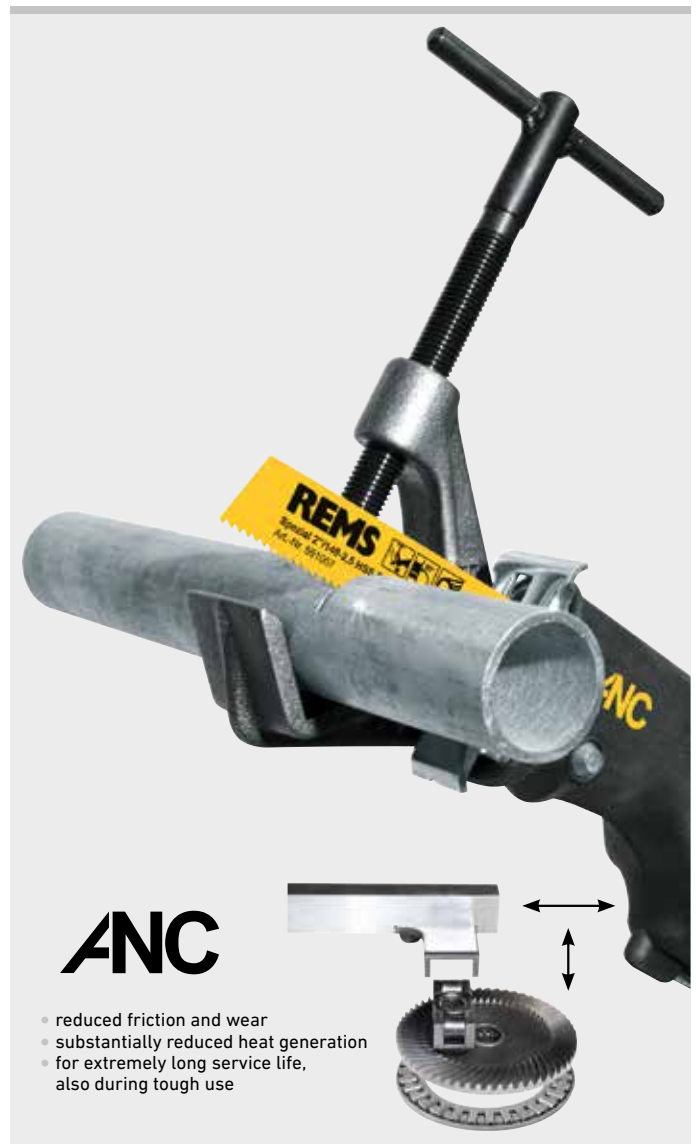

German Quality Product



REMS Tiger/VE/SR

Electric reciprocating pipe saws

Ideal speed (REMS Tiger)

Deliberately fixed speed. Therefore optimum cutting speed for maximum protection of motor and gear and maximum service life of saw blades. The ideal cutting speed of 2,400 rpm has been determined by extensive sawing tests with steel pipe which lead to optimum performance in combination with the aggressive, fixed orbital action, guide support and REMS special saw blade.

Vario-Electronic (REMS Tiger VE)

Electronic stepless speed control of drive unit for sensitive start-sawing and for speed selection during sawing according to the material. Also for plunge-cut sawing. The stroke speed can be continuously controlled by variable pressure on the safety switch from 0 to 2,400 rpm (accelerator switch).

Speed Regulation (REMS Tiger SR)

Stepless electronic speed control of drive unit for selecting the stroke according to the material. Ideal for sawing stainless steel pipe, cast pipe and for sawing boilers, tanks, bath tubs etc. Also for plunge-cut sawing. The number of strokes is steplessly adjustable on the dial from 700 to 2,200 rpm.



Anywhere,
without vice!



German Quality Product



Supply format

REMS Tiger Set. Electric reciprocating pipe saw for effortless, fast, right angle sawing with guide support and for free-hand sawing. Drive unit with straight machine handle, maintenance-free, water and dust resistant oscillating drive with allround needle bearing mounted crank drive (ANC), aggressive orbital action, powerful universal motor 230 V or 110 V, 50–60 Hz, 1050 W, safety tip switch. Fixed stroke 2,400 rpm. Overload protection. Universal saw blade clamp. Hexagon key. Guide support 2". 2 pcs. REMS special saw blades 2"/140-3.2. In sturdy steel case.

	Art.-No.
	560020

Other voltages, also 48 V on request.

Supply format

REMS Tiger VE Set. Electric reciprocating pipe saw with Vario-Electronic for effortless, fast, right angle sawing with guide support and for free-hand sawing. Drive unit with D-shape handle, maintenance-free, water and dust resistant oscillating drive with allround needle bearing mounted crank drive (ANC), aggressive orbital action, powerful universal motor 230 V or 110 V, 50–60 Hz, 1050 W, safety tip switch. Electronic stepless speed control (acceleration switch) 0 to 2,400 rpm. Universal saw blade clamp. Hexagon key. Guide support 2". 2 pcs. REMS special saw blades 2"/140-3.2. In sturdy steel case.

	Art.-No.
	560027

Other voltages on request.

Supply format

REMS Tiger SR Set. Electric reciprocating pipe saw with speed regulation (SR) for effortless, fast, right angle sawing with guide support and for free-hand sawing. Drive unit with straight machine handle, maintenance-free, water and dust resistant oscillating drive with allround needle bearing mounted crank drive (ANC), aggressive orbital action, powerful universal motor 230 V or 110 V, 50–60 Hz, 1400 W, safety tip switch. Stepless electronic speed control 700 to 2,200 rpm with sensitive start-sawing, speed generator, temperature control and stall protection. Universal saw blade clamp. Hexagon key. Guide support 2". 2 pcs. REMS special saw blades 2"/140-3.2. In sturdy steel case.

	Art.-No.
	560026

Other voltages on request.

Accessories

Description	Art.-No.
REMS Tiger drive unit	560000
REMS Tiger VE drive unit	560008
REMS Tiger ANC SR drive unit	560001
REMS saw blades see page 70–71.	
Guide support 2" , for pipes \varnothing 1/2–2"	563000
Guide support 4" , for pipes \varnothing 2 1/2–4"	563100
Guide support 6" , for pipes \varnothing 5–6"	563200
Dual purpose holder for sawing and threading, with REMS Tiger and REMS Amigo E, Amigo, Amigo 2	543100
Protective cap for guide support 2" , 4" and 6", for clamping of thin-walled material	563008
Steel case	566051



REMS Tiger pneumatic

Pneumatic reciprocating pipe saw

Powerful, robust, handy compressed air tool with force-transmitting guide holder for effortless, fast, right-angled sawing everywhere on site, without a vice. Also for universal free-hand sawing. Ideal for use in dangerous, e.g. in wet environment. For assembly, dismantling, repair.

Ideal for steel pipes and others.

Many materials, e.g. wood, wood with nails, pallets, metal, even stainless steel, cast iron, breeze blocks, plaster boards, pumice stone, brick

For materials that are difficult to cut, e.g. stainless steel pipes, hard cast iron, use the REMS Tiger SR with electronic stroke speed control.

REMS Tiger pneumatic – for sawing in dangerous environment.

Saws effortless, fast, right-angle. Force transmitting guide support for 400 % more sawing power. Sturdy, square lift rod. Oscillating drive with ANC.

Aggressive orbital action for fast feed forward sawing and long service life of saw blades. Universal saw blade clamp.

Design

Robust, job site-proven. Slender, handy design. Super light, only 3.8 kg. Can be used anywhere. Ergonomically shaped front housing grip with slip resistant, heat insulating protection cover with soft grip, for forceful feed forward during free-hand sawing. Swivel support shoe for safe guiding of the saw on the material to be sawn. High sliding silicone gasket protects gear against water and dust. Powerful pneumatic motor with ample reserve capacity, 1000 W. Stroke speed control (accelerator switch) 0 to 1,700 rpm. Operating pressure 6 bar, air consumption $\leq 1.6 \text{ m}^3/\text{min}$. Safety switch with lock.

Additional description see REMS Tiger, page 64–65.

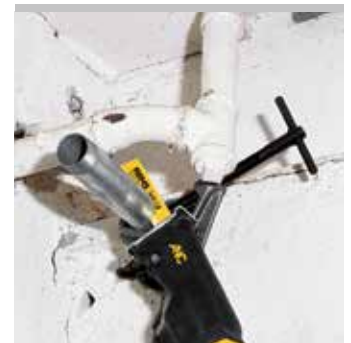

German Quality Product



Info



3.8 kg 1000 W 6 bar



Supply format

REMS Tiger pneumatic Set. Pneumatic reciprocating pipe saw for effortless, fast, right angle sawing with guide support and for free-hand sawing. Drive unit with straight machine handle, maintenance-free, water and dust resistant oscillating drive with allround needle bearing mounted crank drive (ANC), aggressive orbital action, powerful pneumatic 1000 W, operating pressure 6 bar, safety switch with lock. Stroke speed control (accelerator switch) 0 to 1,700 rpm. Air inlet hose, air outlet hose. Universal saw blade clamp. Hexagon key. Guide support 2". 2 pcs. REMS special saw blades 2"/140-3.2. In sturdy steel case.

	Art.-No.
	560022

Accessories

Description	Art.-No.
REMS saw blades see page 70–71.	
REMS Tiger pneumatic drive unit	560002
Guide support 2" , for pipes $\varnothing \frac{1}{8} - 2"$	563000
Guide support 4" , for pipes $\varnothing 2\frac{1}{2} - 4"$	563100
Guide support 6" , for pipes $\varnothing 5 - 6"$	563200
Dual purpose holder for sawing and threading, with REMS Tiger and REMS Amigo E, Amigo, Amigo 2	543100
Protective cap for guide support 2", 4" and 6" , for clamping of thin-walled material	563008
Steel case	566051





REMS

Spezial 2\"/>
Art.-Nr. 501001

ANC

REMS
22V VR

REMS
22V OPEN

REMS
22V

REMS 22V 9.0

REMS 55A 8.0

REMS

REMS

REMS

REMS

REMS

REMS

REMS

REMS

REMS

REMS

Powerful, mobile, handy power tool with force-transmitting guide holder for effortless, fast, right-angled sawing everywhere on site, without a vice. Also for universal free-hand sawing. Only 3.4 kg. Ideal for assembly, dismantling, repair. Li-Ion 22V Technology. For battery and corded operation.

Ideal for steel pipes and others.

Many materials, e.g. wood, wood with nails, pallets, metal, even stainless steel, cast iron, breeze blocks, plaster boards, pumice stone, brick

REMS Tiger 22 V VE – the saw for the pipe fitter.

Saws effortless, fast, right angle. Mobile, handy, light. Li-Ion 21.6V, 9.0 Ah battery, for approx. 80 1" steel pipe cuts with guide holder for approx. 140 1" steel pipe cuts without guide holder with one battery charge*.

Power-transferring guide support

400% additional sawing force for effortless, super fast sawing, e.g. 2" steel pipe in only 11 s. For assembly and dismantling. Guide support with five-fold force transmitting leverage allows effortless, fast, right angled sawing anywhere on site, without a vice. Ideal handling, easy and rapid to operate, positioned with one hand only for chucking and sawing. No loose swinging chain and cumbersome handling as with chain vice. No danger of jamming by limitation of swing angle.

Right angle sawing

Right angle cut thanks to REMS guide support and REMS special saw blade. Essential for subsequent operations in pipe installation.

REMS special saw blade

REMS special saw blade (page 70), extra thick, rigid and unbendable, double tang, absolutely essential for right-angled sawing and fast disassembly of steel pipes with force-transmitting guide holder.

REMS universal saw blade

Only 1 REMS universal saw blade (page 70) for all sawing work instead of many different saw blades. Double tang for free-hand sawing and sawing with guide holder.

REMS saw blades

Full range of REMS saw blades for free-hand sawing of different materials (page 71).

Universal saw blade clamp

All saw blades – with universal or double tang – can be clamped without changing or turning the saw blade thrust piece.

Design

Robust, job site-proven. Mobile, handy, light. Drive unit with battery pack weighs only 3.4 kg. Slim form. Can be used anywhere. Ergonomically shaped front housing grip with slip resistant protection cover for forceful feed forward during free-hand sawing. Practical D-shaped handle with soft grip. Swivel support shoe for safe guiding of the saw on the material to be sawn. High sliding silicone gasket protects gear against water and dust. Powerful 21.6 V battery motor with ample reserve capacity, 500 W output. Safety tip switch. Machine status check with overload protection of the drive unit against too high currents, with overheating protection by motor temperature monitoring (NTC), with electronic battery charging status check with charging level indication by a 2-coloured green/red LED.

Sturdy, square lift rod

In special solid steel, mounted precisely in needle bearings towards the force direction and along the complete stroke length, for distortion-free, precise cutting also during tough use. For extremely long service life. Drive rod runs in an enclosed housing for safe work.

Oscillating drive with ANC

Super stable, water and dust resistant, maintenance-free oscillating drive for simultaneous generation of sawing stroke and orbital action of lift rod and saw blade. Allround needle bearing mounted crank drive (ANC) reduces friction, heat generation, wear. For long service life of drive also at extreme sawing.

Vario-Electronic

Electronic stepless speed control of drive unit for sensitive start sawing and for speed selection during sawing. The speed is controlled by pressing the tip switch steplessly from 0 to 1,900 rpm (acceleration switch).

Aggressive orbital action

Aggressive orbital action by vertical hacking motion of saw blade provides forceful, fast forward feed, excellent chip flow and long service life of saw blades. Fixed orbital action, running in needle bearings, ensures long-lasting and forceful sawing also during extreme load conditions, e.g. sawing of steel pipe.



- reduced friction and wear
- substantially reduced heat generation
- for extremely long service life, also during tough use

German Quality Product



Battery or mains operation

Li-Ion 22V Technology. Highly resistant Li-Ion 21.6V battery with 9.0 Ah capacity, for long service life. Light and powerful, for approx. 80 1" steel pipe cuts with guide holder or approx. 135 1" steel pipe cuts without guide holder with one battery charge*. Graduated charging status check by coloured LEDs. Operating temperature range - 10 to + 60 °C. No memory effect for maximum battery power. Rapid charger 100-240V, 90W. Rapid charger 100-240V, 290W, for shorter charging times, as accessory. Voltage supply 220-240V/21.6V, 40A output, for mains operation instead of Li-Ion battery 21.6 V, as accessory.

Universal saw blade clamp

All saw blades - with universal or double tang - can be clamped without changing or turning the saw blade thrust piece.

Supply format

REMS Tiger 22 V VE Set. Cordless pipe reciprocating saw with Vario Electronics (VE) for effortless, fast, right-angled sawing with guide holder and for free-hand sawing. Drive unit with spade handle, maintenance-free, water and dust proof oscillation drive with all-round needle bearing crank drive (ANC), aggressive orbital stroke, powerful 21.6V, 500 W battery motor, safety switch. Continuous, electronic stroke speed control (accelerator switch) 0 to 1900 rpm. Machine status check with overload protection, temperature monitoring, battery charging status check. Li-Ion 21.6V, 9.0Ah battery, 100-240V, 50-60 Hz, 90W rapid charger. Universal saw blade clamp. Hexagon key. Guide support 2". 2 pcs. REMS special saw blades 2"/140-3.2. In sturdy steel case.

	Art.-No.	
	560053	

Other voltages on request.

Accessories

Description	Art.-No.
REMS Tiger 22 V VE drive unit, without battery	560011
REMS saw blades see page 70 - 71.	
Guide support 2" , for pipes \varnothing 1/2 - 2"	563000
Battery Li-Ion 21.6V, 9.0 Ah	571583
Rapid charger 100-240V, 50-60 Hz, 90W	571585
Rapid charger 100-240V, 50-60 Hz, 290W	571587
Voltage supply 220-240V/21.6V, 50-60 Hz, 40A , for mains operation instead of battery Li-Ion 21.6V	571578
Steel case with inlay	566030
REMS Lumen 2800 22V , cordless LED flood light, see page 111	



* Ambient temperature approx. 20°C.

REMS special saw blades

For REMS Tiger/VE/SR, Tiger pneumatic, Tiger 22V VE and other makes

Special saw blades for right angle sawing and for fast dismantling of steel pipes with power transmitting guide support.

Steel pipes

REMS special saw blades – for right-angled sawing with force-transmitting guide holder, for 400% more sawing power.

Specially developed for REMS Tiger.

Absolutely essential for right angle sawing and for fast dismantling with power transmitting guide support. This produces multiple thrust pressure by a five-fold force-transmitting leverage, for 400% more sawing power. Normal saw blades with single tang do not withstand the high feed pressure during sawing with guide support, they break at the mounting point.

For this reason, extra thick REMS special saw blade, resistant to bending and distortion.

Double tang mounting with exceptionally wide clamping face ensures accurate seating and high stability.

Coarse, corrugated tooth pattern for rapid sawing. Long service life.

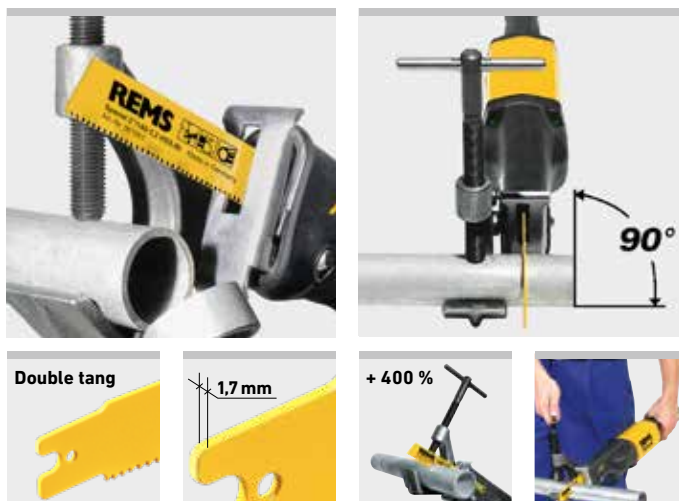

German Quality Product



REMS special saw blades → REMS Tiger, etc.	Ø inches/ Length mm	Tooth pitch mm	Material*	Teeth	Colour			Art.-No.
REMS special saw blade 2"/140-2.5 steel pipes ≤ 2"	2"/140	2.5	HSS-Bi		yellow	5		561007
REMS special saw blade 2"/140-3.2 steel pipes ≤ 2"	2"/140	3.2	HSS-Bi		yellow	5		561001
REMS special saw blade 4"/200-3.2 steel pipes ≤ 4"	4"/200	3.2	HSS-Bi		yellow	5		561002
REMS special saw blade 6"/260-3.2 steel pipes ≤ 6"	6"/260	3.2	HSS-Bi		yellow	5		561008

For hard-to-machine materials, e.g. stainless steel pipes, hard cast iron pipes, use the finer toothed REMS universal saw blade instead of the REMS special saw blade in combination with REMS Tiger SR with electronic speed regulation (page 65).

REMS universal saw blades

For REMS Cat VE, Tiger/VE/SR, Cat 22V VE and other makes

Universal saw blade for free-hand sawing and for sawing with power transmitting guide support. Instead of many different saw blades.

Many materials, e.g. wood, wood with nails, pallets, metal, even stainless steel, cast iron, breeze blocks, plaster boards, pumice stone, brick

Highly flexible, also ideal for sawing flush with the wall.

REMS universal saw blades – for all sawing jobs.

Only 1 universal saw blade instead of many different saw blades for all sawing jobs.

Resilient material, highly flexible, also for flush-to-wall sawing.

Double tang mounting with exceptionally wide clamping face for accurate seating and high stability. Also for sawing with power transmitting guide support. Single tang saw blades are unable to cope with the high thrust pressure when sawing with a guide holder, they break at the clamping point.

Alternating tooth pitch (combi-teeth) for fast, smooth cut, very highly hardened in the teeth area. Straight-set teeth.

Thus outstanding cutting performance and prolonged service life.

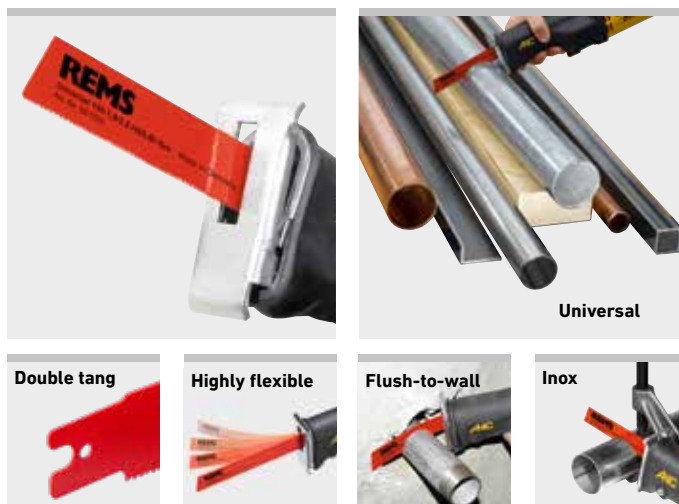

German Quality Product



REMS universal saw blades → REMS Tiger, REMS Cat, etc.	Length mm	Tooth pitch mm	Material*	Teeth	Colour			Art.-No.
REMS universal saw blade 100-1.8/2.5 for all sawing work	100	Combo 1.8/2.5	HSS-Bi flexible		red	5		561006
REMS universal saw blade 150-1.8/2.5 for all sawing work	150	Combo 1.8/2.5	HSS-Bi flexible		red	5		561005
REMS universal saw blade 200-1.8/2.5 for all sawing work	200	Combo 1.8/2.5	HSS-Bi flexible		red	5		561003
REMS universal saw blade 300-1.8/2.5 for all sawing work	300	Combo 1.8/2.5	HSS-Bi flexible		red	5		561004

Also for nail-embedded wood, pallets. For hard-to-machine materials, e.g. stainless steel pipes, hard cast iron pipes, lower speed required, e.g. by using REMS Tiger SR with electronic speed regulation (page 65).





REMS saw blades

For REMS Puma VE, Cat VE, Tiger VE/SR,
Cat 22V VE, Tiger 22V VE and other makes

Saw blades for free-hand sawing for different materials.





















Alternating tooth pitch (combi-teeth) for fast, smooth cut, also when sawing mixed materials (wood/metal).

Flexible saw blades, also for sawing flush with wall.

-  Corrugated teeth for smooth cut with low tooth pitch.
-  Straight-set teeth for aggressive cut with coarse tooth pitch.
-  Straight teeth for saw blades with very wide carbide teeth.
-  Carbide-granulate for materials that are difficult to cut.















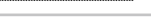

German Quality Product



















REMS saw blades for metal → REMS Puma, REMS Cat, REMS Tiger, etc.	Length mm	Tooth pitch mm	Material*	Teeth	Colour			Art.-No.
REMS saw blade 150-1 sheet metal, metal, also stainless steel, ≥ 1.2 mm	150	1	HSS-Bi flexible		red	5		561105
REMS saw blade 200-1 sheet metal, metal, also stainless steel, ≥ 1.2 mm	200	1	HSS-Bi flexible		red	5		561106
REMS saw blade 90-1.4 , curved blade metal, also stainless steel, ≥ 1.5 mm	90	1.4	HSS-Bi		red	5		561107
REMS saw blade 150-1.4 metal, also stainless steel, ≥ 1.5 mm	150	1.4	HSS-Bi flexible		red	5		561104
REMS saw blade 200-1.4 metal, also stainless steel, ≥ 1.5 mm	200	1.4	HSS-Bi flexible		red	5		561108
REMS saw blade 100-1.8 metal, also stainless steel, ≥ 2 mm	100	1.8	HSS-Bi flexible		red	5		561101
REMS saw blade 150-1.8 metal, also stainless steel, ≥ 2 mm	150	1.8	HSS-Bi flexible		red	5		561103
REMS saw blade 200-1.8 metal, also stainless steel, ≥ 2 mm	200	1.8	HSS-Bi flexible		red	5		561102
REMS saw blade 200-2.5 metal, also stainless steel, ≥ 3 mm	200	2.5	HSS-Bi flexible		red	5		561109
REMS saw blade 280-2.5 metal, also stainless steel, ≥ 3 mm	280	2.5	HSS-Bi flexible		red	5		561112

German Quality Product

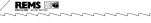

REMS saw blades for wood and metal → REMS Puma, REMS Cat, REMS Tiger, etc.	Length mm	Tooth pitch mm	Material*	Teeth	Colour			Art.-No.
REMS saw blade 210-1.8/2.5 round tip, no sticking pallets, wood, wood with nails, metal ≥ 2.5 mm	210	Combo 1.8/2.5	HSS-Bi flexible		black	5		561113
REMS saw blade 150-2.5 wood, wood with nails, pallets, metal ≥ 3 mm	150	2.5	HSS-Bi flexible		black	5		561110
REMS saw blade 225-2.5 , extra thick, for disassembly wood, wood with nails, metal ≥ 3 mm	225	2.5	HSS-Bi		black	3		561114
REMS saw blade 300-2.5 , extra thick, for disassembly wood, wood with nails, metal ≥ 3 mm	300	2.5	HSS-Bi		black	3		561116
REMS saw blade 300-4.2 wood	300	4.2	WS		black	5		561111
REMS saw blade 225-3.2/5.0 wood, wood with nails	225	Combo 3.2/5.0	HSS-Bi flexible		black	5		561117
REMS saw blade 290-5.0/6.35 green wood	290	Combo 5.0/6.35	WS		black	5		561118
REMS saw blade 150-6.35 wood	150	6.35	WS		black	5		561119



REMS saw blades for different purposes → REMS Puma, REMS Cat, REMS Tiger, etc.	Length mm	Tooth pitch mm	Material*	Teeth	Colour			Art.-No.
REMS saw blade 150-4.2 breeze blocks, plasterboard	150	4.2	WS		white	5		561115
REMS saw blade 225-8.5 breeze blocks, hard wood	225	8.5	HM		white	1		561120
REMS saw blade 300-8.5 breeze blocks, hard wood	300	8.5	HM		white	1		561121
REMS saw blade 400-8.5 breeze blocks, hard wood	400	8.5	HM		white	1		561122
REMS saw blade 235-12 breeze blocks, pumice, brick	235	12	HM		white	1		561123
REMS saw blade 300-12 breeze blocks, pumice, brick	300	12	HM		white	1		561124
REMS saw blade 300-12 , extra high blade breeze blocks, pumice, brick	300	12	HM		white	1		561125
REMS saw blade 200 cast iron etc.	200		HM-G		white	2		561126



* HSS-Bi: bimetal high speed steel WS: tool steel HM: carbide HM-G: carbide-granulate

Compact, portable circular pipe sawing machine for burr-reduced, right angle and rapid sawing. For stainless steel pipes, carbon steel pipes and copper pipes of the press fitting systems etc. Also for cutting thin-walled sections for front-wall installation. For job site and workshop.

Stainless steel pipes, carbon steel pipes, copper pipes and other materials	≤ Ø 76 mm
REMS saw blade	Ø 225 mm

REMS Turbo Cu-INOX – burr-reduced, right angle, rapid. Burr-reduced sawing through double clamping vice. Powerful, e.g. Ø 22 mm in only 4 s. Easy to transport.

Ideal for pressfitting systems

In accordance with requirements:

Dry sawing, so no damage to O-rings from lubricants.

Burr-reduced through double clamping vice.

Optimum cutting speed prevents degradation of pipe material through overheating.

Design

Compact, robust, job site-proven. Small in size, handy, portable, only 17 kg. Easy sawing through favourable leverage effect. Fast saw blade change. Precise sawing. Mark on the saw blade protection cover showing the saw blade cutting line. Connection for driving outer/inner pipe deburrer REMS REG 10–54 E. For workbench, stand or wheel stand as an accessory, for easy transport, optimum working height and stable positioning.

Universal double clamping vice

Robust, easy-running universal double clamping vice for burr-reduced sawing. Both pipe ends remain securely clamped during sawing. Easy, secure clamping also of thin-walled pipes through inclined jaw. Only one strong clamping spindle for both clamping sides ensures even, effortless and secure clamping of the material.

Drive

Robust gear, precisely mounted in roller and needle bearings, maintenance-free. Proven universal motor, 500 W. Powerful, e.g. stainless steel pipe Ø 22 mm in only 4 s. Ideal speed 60 rpm for optimum cutting speed and smooth sawing.

REMS saw blades

Top German quality. REMS circular saw blade HSS 225 × 2 × 32 mm, 220 teeth, for metal, adjusted to the efficiency of REMS Turbo Cu-INOX for sawing stainless steel tubes. Specially fine-toothed, hardened and ground. For easy and exact sawing. Prolonged durability. REMS circular saw blade HSS-E (cobalt alloyed) 225 × 2 × 32 mm, 220 teeth, for metal, for even better durability. Specially fine-toothed, hardened and ground.

Outer/inner pipe deburrer

Outer/inner pipe deburrer REMS REG 10–54 E for pipes Ø 10–54 mm, Ø ½–2 ¼", for electric drive with the REMS Turbo Cu-INOX pipe circular sawing machine and others, see page 101.

Supply format

REMS Turbo Cu-INOX Basic. Circular pipe saw with universal double clamping vice for burr-reduced, right angle, rapid sawing. For stainless steel pipes, carbon steel pipes and copper pipes of the press fitting systems etc. Also for cutting thin-walled sections for front-wall installation. For REMS saw blade Ø 225 mm. With maintenance-free gear, proven universal motor 230 V or 110 V, 50–60 Hz, 500 W. Safety tip switch, saw blade protection cover. Speed 60 rpm. Ring spanner. Hexagon key. Without saw blade. For workbench, stand or wheel stand. In a carton.

	Art.-No.
	849006

Other voltages on request.

Accessories

Description	Art.-No.
REMS circular saw blade HSS for metal, specially for stainless steel pipes, fine-toothing, 225 × 2 × 32 mm, 220 teeth.	849703
REMS circular saw blade HSS-E (cobalt alloyed) circular saw blade HSS-E (cobalt alloyed) toothing, 225 × 2 × 32 mm, 220 teeth. Very long service life.	849706
REMS REG 10–54 E outer/inner pipe deburrer, see page 101	
Stand	849315
Wheel stand	849310
REMS Jumbo , folding workbenches, see page 106.	
REMS Herkules , material supports, see page 107.	



German Quality Product



Info



REMS Turbo K

Universal circular metal sawing machine with automatic cooling lubricant unit

Compact, mobile, universal circular metal sawing machine for installation, metal working and industry. For job site and workshop.

↶	○	□	▭	└	●	■	■
90° ⊕	78	55	70 × 50	50 × 50	40	40	50 × 30
45° ⊕	60	55	60 × 40	50 × 50	40	40	50 × 30

REMS saw blade Ø 225 mm

REMS Turbo K – the most powerful in its class.
Progressive drive, e.g. 2" steel pipe in only 5 s.
Easy to transport.

Design

Compact, robust, job site-proven. Small in size, handy, portable, complete only 22 kg. Automatic cooling lubricant unit. Easy sawing through favourable leverage effect. Fast saw blade change. Precise sawing. For workbench, stand or wheel stand as an accessory, for easy transport, optimum working height and stable positioning.

Universal vice

Robust, easy-running universal vice with strong clamping spindle and large clamping lever for effortless, secure clamping of the material. Standard with clamp insert for thin-walled pipes. Quick setting of bevel angle thanks to clearly laid out scale and clamping lever. Simple, sturdy length stop.

Drive

Robust, maintenance-free gear, precisely mounted in roller and needle bearings. Proven universal motor, 1200 W. Extremely strong and powerful, e.g. 2" steel pipe in only 5 s. Ideal speed 115 rpm for fast and smooth sawing.

REMS saw blades

Top German quality. REMS universal circular saw blade HSS 225 × 2 × 32 mm for metal, 120 teeth, adjusted to the efficiency of REMS Turbo K. Specially toothed, hardened and ground. For easy and exact sawing. REMS universal circular saw blade HSS 225 × 2 × 32 mm, 220 teeth, adjusted for sawing stainless steel. Specially fine-toothed, hardened and ground. For an even better durability, REMS universal circular saw blade HSS-E (cobalt alloyed) 225 × 2 × 32 mm, 220 teeth. Specially fine-toothed, hardened and ground.

Kühlschmierstoffe

REMS Sanitol and REMS Spezial (page 49). High lubricating and cooling effect. Essential for clean cuts, long service life of saw blades and machine.

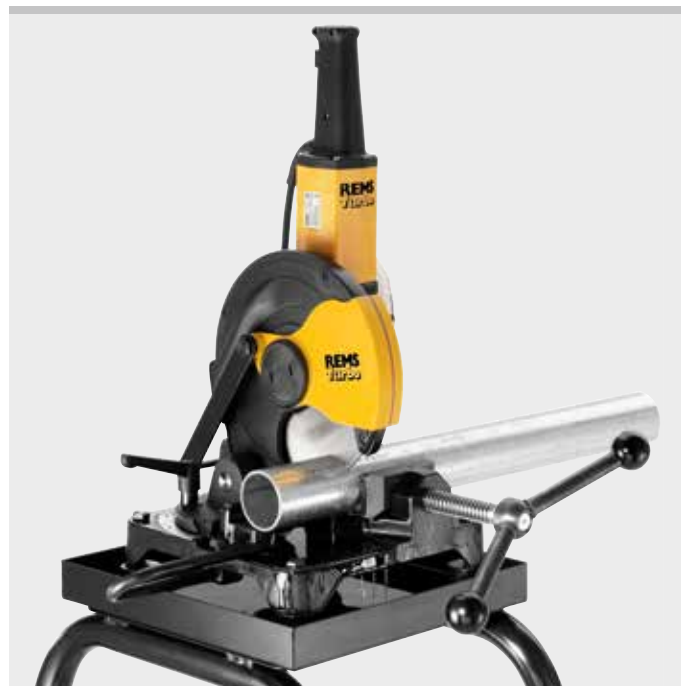

German Quality Product



Info

Supply format

REMS Turbo K Basic. Universal circular metal sawing machine with automatic cooling lubricant unit. For straight cuts and bevel cuts up to 45°. For REMS saw blade Ø 225 mm. Maintenance-free gear. Proven, powerful universal motor 230 V or 110 V, 50–60 Hz, 1200 W. Safety tip switch, saw blade protection cover, length stop. Clamp insert for thin-walled pipes. Speed 115 rpm. Ring spanner. Hexagon key. 1 filling of cooling lubricant REMS Spezial. Without saw blade. For workbench, stand or wheel stand. In a carton.

	Art.-No.
	849007

Other voltages on request.

Accessories

Description	Art.-No.
REMS universal circular saw blade HSS for metal, 225 × 2 × 32 mm, 120 teeth	849700
REMS circular saw blade HSS for metal , fine-toothed, 225 × 2 × 32 mm, 220 teeth	849703
REMS circular saw blade HSS-E (cobalt alloyed) for metal, fine-toothed, 225 × 2 × 32 mm, 220 teeth. Very long service life.	849706
Electronic speed regulator for hard-to-machine materials, e.g. stainless steel pipes, hard cast iron pipes. Fixed, optimum speed.	565051
Cooling lubricants see page 49.	
Stand	849315
Wheel stand	849310
REMS Jumbo , folding workbenches, see page 106.	
REMS Herkules , material supports, see page 107.	





Made in Germany

REMS

Cutting Chamfering Deburring

	Pipe cutters	76
	Cutter wheels	83
	Electric pipe cutter/ Cordless pipe cutter	84
	Pipe cutting machines	86
	Pipe shears	92
	Pipe cutting and pipe chamfering tools	96
	Pipe deburrers	99

Robust quality tools for cutting pipes.
Meets high demands and long service life.

Steel pipes \varnothing 1/8 – 4", \varnothing 10 – 115 mm

REMS RAS St – quality pipe cutters.

Solid body in forged steel.

Robust spindle, long spindle guidance and hardened back pressure rollers provide exact alignment to the pipe and a long service life.

Ergonomic, wide handle provides a powerful in-feed of spindle.

Broad, precise cutter wheel bearing on a hardened, non rotating wheel shaft guarantees a right angle cut.

Specially hardened cutter wheel in approved, tough-hard REMS die-steel quality ensures a long service life.

Cutter wheel protected against touching the back pressure rollers by in-feed limitation.

Only 1 cutter wheel for pipes \varnothing 1/8 – 4" (10 – 115 mm), wall thickness $s \leq 8$ mm, suitable for both pipe cutters. Cutter wheel for pipes \varnothing 1 – 4" to wall thickness $s \leq 12.5$ mm available as accessory.



German Quality Products



Info

Supply format

REMS RAS St. Pipe cutter for steel pipes. With cutter wheel. In a carton.

Description	Pipes \varnothing mm/inch	Wall thickness $s \leq$ mm	Art.-No.
St 1/8 – 2"	1/8 – 2" 10 – 60	8	113000
St 1 1/4 – 4"	1 1/4 – 4" 30 – 115	8	113100

Accessories

Description	$s \leq$ mm	Art.-No.
REMS cutter wheel St 1/8 – 4", s 8 for REMS RAS St 1/8 – 2" and St 1 1/4 – 4"	8	341614
REMS cutter wheel St 1 – 4", s 12 for REMS RAS St 1 1/4 – 4"	12.5	381622



REMS RAS Cu-INOX

Pipe cutters

Robust quality tools for cutting tubes.
Particularly suited for cutting stainless steel tubes.

Copper tubes, thin-walled
stainless steel tubes, thin-walled
steel, aluminium, brass tubes Ø 3 – 120 mm
Ø 1/8 – 4"

REMS RAS Cu-INOX – for places with difficult access.

Small, handy, specially for use in restricted spaces.

Robust design and hardened back pressure rollers provide exact alignment to the tube and a long service life.

Large operating knob in metal for easy in-feed and cutting.

Broad, precise cutter wheel bearing on a hardened, non rotating wheel shaft guarantees a right angle cut.

Specially hardened cutter wheel in approved, tough-hard REMS die-steel quality ensures a long service life. Fast changing of cutter wheel without tools by cutter wheel axle with ball catch. Cutter wheel protected against touching the back pressure rollers by in-feed limitation.

REMS RAS Cu-INOX 3–28 S Mini with needle bearing cutter wheel and needle bearing counter-pressure rollers for very easy cutting.



Supply format

REMS RAS Cu-INOX. Pipe cutter for copper tubes, thin-walled stainless steel tubes, thin-walled steel, aluminium, brass tubes. With cutter wheel. In blister pack.

Description	Pipes Ø mm/inch	Wall thickness s ≤ mm	Art.-No.
Cu-INOX 3–16	3–16 1/8–5/8"	4	113200
Cu-INOX 3–25	3–25 1/8–1"	4	113230
Cu-INOX 3–28 Mini	3–28 1/8–1 1/8"	4	113240
Cu-INOX 3–28 S Mini on needle bearings	3–28 1/8–1 1/8"	4	113241



Info



REMS RAS Cu-INOX – the compact version with telescopic spindle.

Telescopic spindle. Easy, quick adjustment in both directions.

Compact design for tough use.

Sturdy telescopic spindle, long spindle guidance and 4 specially hardened back pressure rollers ensure exact alignment to the tube, easy in-feed, easy cutting and precise, right angle cut.

Ergonomic, handy operating knob in metal for easy work and long service life.

Specially hardened cutter wheel in approved, tough-hard REMS die-steel quality ensures a long service life. Fast changing of cutter wheel without tools by cutter wheel axle with ball catch. Cutter wheel protected against touching the back pressure rollers by in-feed limitation.

REMS RAS Cu-INOX 3–35 S with needle bearing cutting wheel and needle bearing counter-pressure rollers for very easy cutting.

Integrated pipe deburring device, on rotating bearing, adapts to the workpiece edge to be deburred.

Specially hardened and ground universal deburring blade guarantees easy deburring and extremely long life.

Fast, simple blade change.

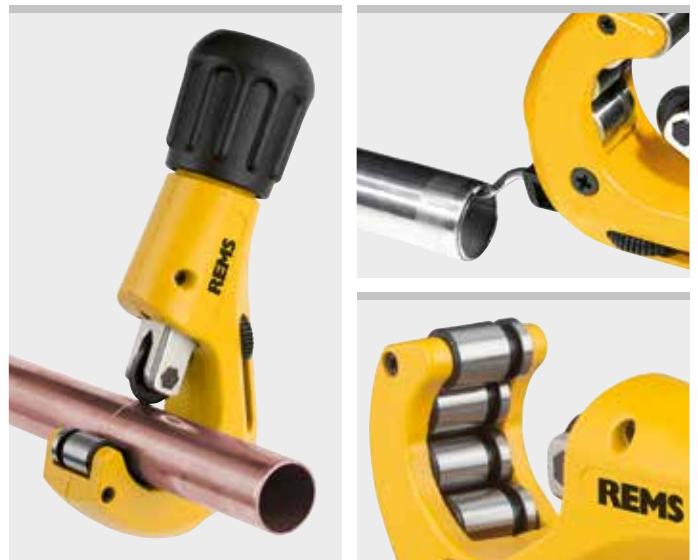

Supply format

REMS RAS Cu-INOX. Pipe cutting machine for copper pipes, thin-walled stainless steel pipes, thin-walled steel-aluminium pipes, brass pipes, with integrated pipe deburring device. With cutter wheel. In blister pack.

Description	Pipes Ø mm/inch	Wall thickness s ≤ mm	Art.-No.
Cu-INOX 3–35	3–35 1/8–1 3/8"	4	113350
Cu-INOX 3–35 S on needle bearings	3–35 1/8–1 3/8"	4	113351
Cu-INOX 3–42	3–42 1/8–1 3/4"	4	113330



REMS RAS Cu-INOX – quality pipe cutter.

Robust, solid design for heavy-duty application.

Sturdy spindle, long spindle guidance and hardened back pressure rollers provide exact alignment to the tube, easy in-feed, easy cutting and precise, right angle cut.

Ergonomic, handy operating knob in metal for easy work and long service life.

Specially hardened cutter wheel in approved, tough-hard REMS die-steel quality ensures a long service life.

Cutter wheel protected against touching the back pressure rollers by in-feed limitation.

REMS RAS Cu-INOX 8 – 64 S with needle bearing cutting wheel and needle bearing counter-pressure rollers for very easy cutting. Quick adjustment of the engagement spindle in both directions.

Only 1 cutter wheel for the complete working capacity \varnothing 3 – 120 mm.



Supply format

REMS RAS Cu-INOX. Pipe cutter for copper tubes, thin-walled stainless steel tubes, thin-walled steel, aluminium, brass tubes. With cutter wheel. In blister pack/in box.

Description	Pipes \varnothing mm/inch	Wall thickness s \leq mm	Art.-No.
Cu-INOX 3 – 28	3 – 28 1/8 – 1 1/8"	4	113300
Cu-INOX 6 – 42	6 – 42 1/4 – 1 5/8"	4	113380
Cu-INOX 6 – 64	6 – 64 1/4 – 2 1/2"	4	113400
Cu-INOX 8 – 64 S on needle bearings, with quick adjustment	8 – 64 3/8 – 2 1/2"	4	113401
Cu-INOX 64 – 120	64 – 120 2 1/2 – 4"	4	113500

Accessories

Description	Wall thickness s \leq mm	Art.-No.
REMS cutter wheel Cu-INOX 3 – 120, s 4	4	113210
REMS cutter wheel Cu-INOX 3 – 120 S, s 4, on needle bearings	4	113213
Universal deburring blade, ground		113360



Robust quality tools for cutting tubes.

Copper tubes Ø 3 – 64 mm
Ø 1/8 – 2 1/2"

REMS RAS Cu – for places with difficult access.

Small, handy, specially for use in restricted spaces.

Robust design and hardened back pressure rollers provide exact alignment to the tube and a long service life.

Large operating knob in metal for easy in-feed and cutting.

Broad, precise cutter wheel bearing on a hardened, non rotating wheel shaft guarantees a right angle cut.

Specially hardened cutter wheel in approved, tough-hard REMS die-steel quality ensures a long service life. Fast changing of cutter wheel without tools by cutter wheel axle with ball catch. Cutter wheel protected against touching the back pressure rollers by in-feed limitation.

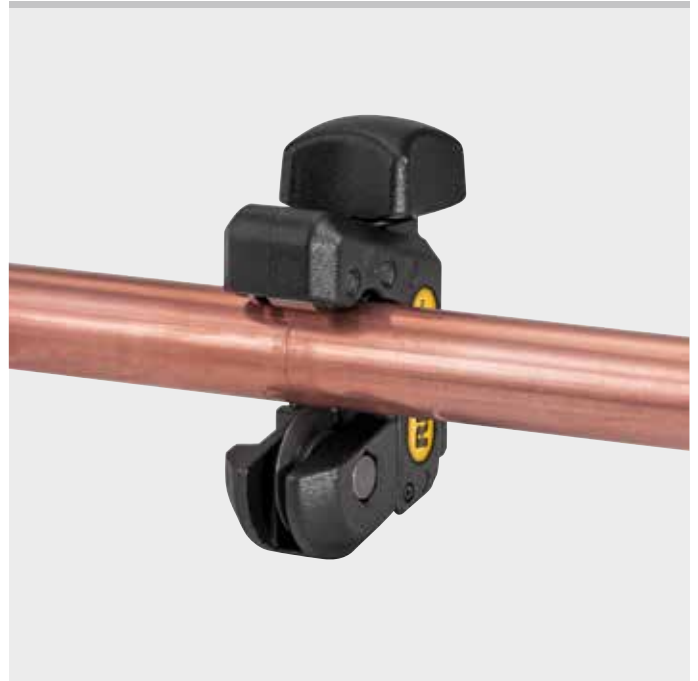

Supply format

REMS RAS Cu. Pipe cutter for copper tubes. With cutter wheel. In blister pack.

Description	Pipes Ø mm/inch	Wall thickness s ≤ mm	Art.-No.
Cu 3 – 16	3 – 16 1/8 – 5/8"	3	113250
Cu 3 – 25	3 – 25 1/8 – 1"	3	113255
Cu 3 – 28	3 – 28 1/8 – 1 1/8"	3	113260

REMS RAS Cu – the compact version with telescopic spindle.

Telescopic spindle. Easy, quick adjustment in both directions.

Compact design for tough use.

Sturdy telescopic spindle, long spindle guidance and 4 specially hardened back pressure rollers ensure exact alignment to the tube, easy in-feed, easy cutting and precise, right angle cut.

Ergonomic, handy operating knob in metal for easy work and long service life.

Specially hardened cutter wheel in approved, tough-hard REMS die-steel quality ensures a long service life. Fast changing of cutter wheel without tools by cutter wheel axle with ball catch. Cutter wheel protected against touching the back pressure rollers by in-feed limitation.

Integrated pipe deburring device, on rotating bearing, adapts to the workpiece edge to be deburred.

Specially hardened and ground universal deburring blade guarantees easy deburring and extremely long life.

Fast, simple blade change.

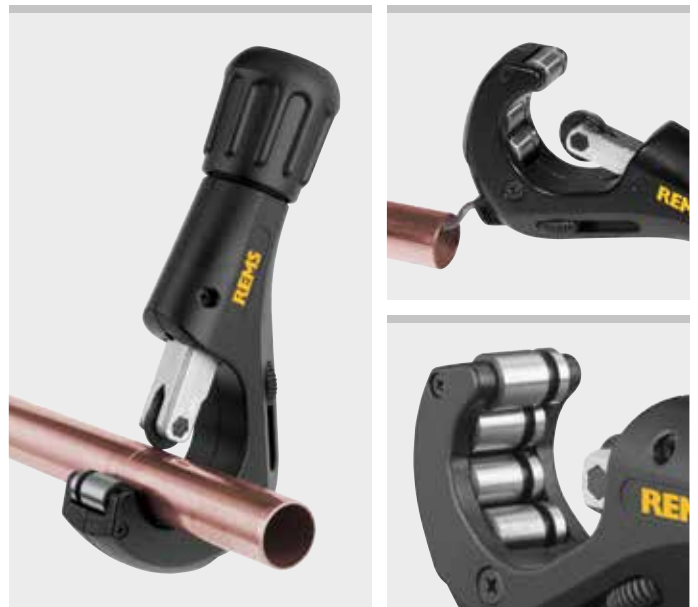

Supply format

REMS RAS Cu. Pipe cutter for copper tubes, with integrated pipe deburring device. With cutter wheel. In blister pack.

Description	Pipes Ø mm/inch	Wall thickness s ≤ mm	Art.-No.
Cu 3 – 35	3 – 35 1/8 – 1 3/8"	3	113340
Cu 3 – 42	3 – 42 1/8 – 1 3/4"	3	113320



REMS RAS Cu

Pipe cutters

REMS RAS Cu – quality pipe cutter. With quick adjustment.

Solid, handy, U-shaped design.

Sturdy spindle, long spindle guidance and hardened back pressure rollers provide exact alignment to the pipe, easy in-feed, easy cutting and precise, right angle cut.

Ergonomic, handy operating knob in metal for easy work and long service life.

Ratchet for quick adjustment in both directions.

Specially hardened cutter wheel in approved, tough-hard REMS die-steel quality ensures a long service life.

Cutter wheel protected against touching the back pressure rollers by in-feed limitation.

Only 1 cutter wheel for the complete working capacity \varnothing 3 – 120 mm.

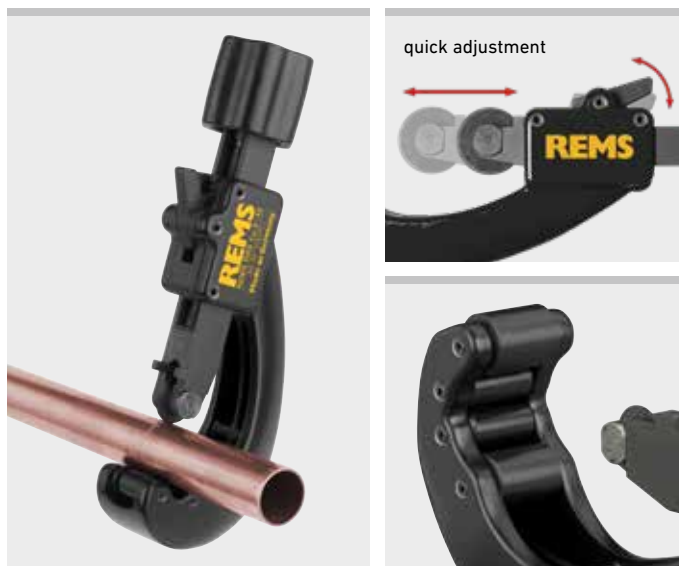

German Quality Products

Supply format

REMS RAS Cu. Pipe cutter for copper tubes. With cutter wheel.
In blister pack/in box.

Description	Pipes \varnothing mm/inch	Wall thickness s \leq mm	Art.-No.
Cu 8 – 42 with quick adjustment	8 – 42 $\frac{3}{8}$ – $1\frac{7}{8}$ "	3	113370
Cu 8 – 64 with quick adjustment	8 – 64 $\frac{3}{8}$ – $2\frac{1}{2}$ "	3	113410

Accessories

Description	Wall thick- ness s \leq mm	Art.-No.
REMS cutter wheel Cu 3 – 120, s 3	3	113225
Universal deburring blade, ground		113360

International
Design Award



REMS RAS P

Pipe cutters

REMS RAS P – the compact version with telescopic spindle.

Telescopic spindle. Easy, quick adjustment in both directions.

Compact design for tough use.

Sturdy telescopic spindle, long spindle guidance and 4 specially hardened back pressure rollers ensure exact alignment to the tube, easy in-feed, easy cutting and precise, right angle cut.

Ergonomic, handy operating knob in metal for easy work and long service life.

Specially hardened cutter wheel in approved, tough-hard REMS die-steel quality ensures a long service life. Fast changing of cutter wheel without tools by cutter wheel axle with ball catch. Cutter wheel protected against touching the back pressure rollers by in-feed limitation.

Integrated pipe deburring device, on rotating bearing, adapts to the workpiece edge to be deburred.

Specially hardened and ground universal deburring blade guarantees easy deburring and extremely long life.

Fast, simple blade change.



Supply format

REMS RAS P. Pipe cutter for plastic pipes and multi-layer composite tubes, with integrated pipe deburring device. With cutter wheel. In blister pack.

Description	Pipes \varnothing mm/inch	Wall thickness s \leq mm	Art.-No.
P 10 – 32 T	10 – 32 $\frac{1}{2}$ – $1\frac{3}{8}$ "	4,5	290001
P 10 – 40 T	10 – 40 $\frac{1}{2}$ – $1\frac{5}{8}$ "	4,5	290002



High performance quality tools for cutting pipes.
With quick adjustment.

Plastic pipes,
multi-layer composite tubes \varnothing 10–315 mm
 \varnothing ½–12"

REMS RAS P – quality pipe cutter. With quick adjustment.

Solid, handy, U-shaped design.

Sturdy spindle, long spindle guidance and hardened back pressure rollers provide exact alignment to the pipe, easy in-feed, easy cutting and precise, right angle cut. Ergonomic, handy operating knob in metal for easy work and long service life.

Ratchet for quick adjustment in both directions.

Specially hardened cutter wheel in approved, tough-hard REMS die-steel quality ensures a long service life.

Cutter wheel protected against touching the back pressure rollers by in-feed limitation.

Cutter wheels for different wall thicknesses (s).

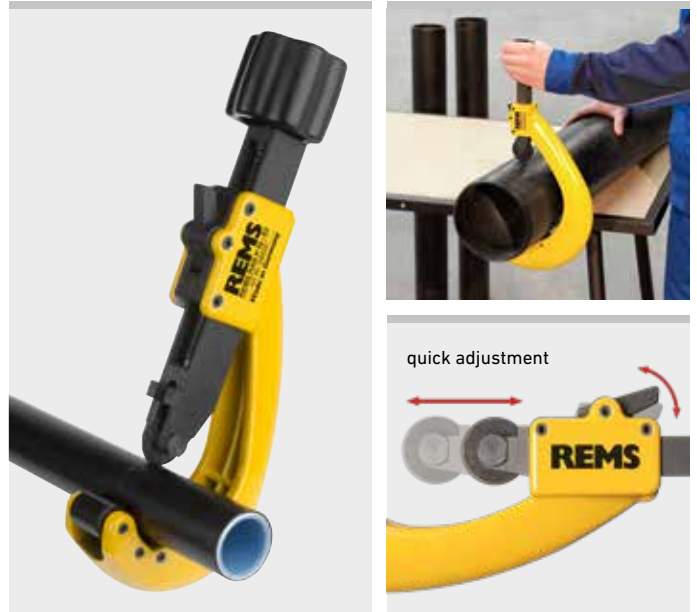

German Quality Products



Info



P 50–110, s11
P 50–110, s16
P 50–110, s19



Supply format

REMS RAS P. Pipe cutter for plastic pipes and multi-layer composite tubes. With cutter wheel. In blister pack/in box.

Description	Pipes \varnothing mm/inch	Wall thickness s ≤ mm	Art.-No.
P 10–40 with quick adjustment	10–40 ½–1½"	7	290050
P 10–63 with quick adjustment	10–63 ½–2"	7	290000
P 50–110, s11 with quick adjustment	50–110 2–4"	11	290100
P 50–110, s16 with quick adjustment	50–110 2–4"	16	290100
P 50–110, s19 with quick adjustment	50–90 2–3"	19	290100
P 110–160 with quick adjustment	110–160 4–6"	16	290200

REMS RAS P – cutting up to \varnothing 315 mm, s ≤ 19 mm.

Fast and inexpensive cutting of large pipes. Quick adjustment.
Separate pipe centering for right angle cutting.

Solid design, double-T-shaped body.

Cutter wheels for different wall thicknesses (s).

Supply format

REMS RAS P. Pipe cutter for plastic pipes and multi-layer composite tubes. With cutter wheel and spare cutter wheel. In sturdy steel case.

Description	Pipes \varnothing mm/inch	Wall thickness s ≤ mm	Art.-No.
P 180–315 with quick adjustment	180–315 7–12"	16	290300



Accessories

Description	s ≤ mm	Art.-No.
REMS cutter wheel P 10–40, s 4,5 for REMS RAS P 10–32 T, 10–40 T	4,5	290023
REMS cutter wheel P 10–63, s 7 for REMS RAS P 10–40, 10–63	7	290016
REMS cutter wheel P 50–315, s 11 for REMS RAS P 50–110, 110–160, 180–315	11	290116
REMS cutter wheel P 50–315, s 16 for REMS RAS P 50–110, 110–160, 180–315	16	290216
REMS cutter wheel P 50–315, s 19 for REMS RAS P 50–110, 110–160, 180–315	19	290316



REMS RAS P/SW 45/L

Pipe cutter/pipe slitter

Robust quality tool with two cutting systems for cutting and slitting plastic corrugated protective pipes.

Cutting	$\varnothing \leq 45 \text{ mm}$ $\varnothing \leq 1\frac{3}{4}''$
Slitting (lengthwise cutting)	ID $\geq \varnothing 14 \text{ mm}$

REMS RAS P/SW 45/L – Cutting and slitting of plastic corrugated protective pipes.

Stable magnesium version, extremely light.

Specially hardened and specially ground blades for cutting and slitting. German quality product.

Four-edged, wedge-shaped blades with a cutting angle of 90°, rotatable 4 times by 90° for four times longer life. Right-angled, burr-free cutting by pipe rest with shaft guide.

Automatic contact pressure when cutting.

Cutting depth limiting of the cutting tools during cutting prevents damage to the inside of the pipe.



Info

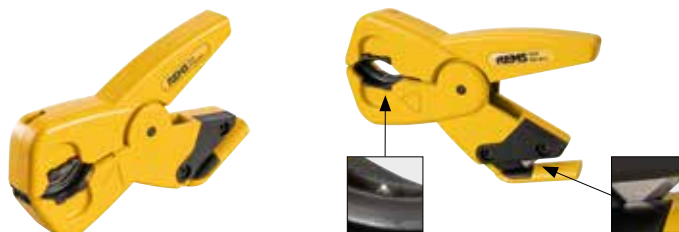

Supply format

REMS RAS P/SW 45/L. Pipe cutter/pipe slitter for plastic corrugated protective pipes. With 3 blades. In blister pack.

Pipes \varnothing mm/inch	Art.-No.
$\leq 45 \text{ mm} / \leq 1\frac{3}{4}''$	113480

Accessories

Description	Art.-No.
Blade P/SW 45/L (pack of 3) for REMS RAS P/SW 45/L	113481



REMS RAS W INOX

Pipe cutter

Highly resistant quality tool for cutting pipes.

Corrugated metal hoses (corrugated pipes) of stainless steel, also jacketed $\text{DN } 10 - 32 (40)$
 $\frac{3}{8} - 1\frac{1}{2}'' (2'')$

REMS RAS W INOX 10–32/40 S – Quality pipe cutter especially for cutting corrugated metal hoses (corrugated pipes) made of stainless steel.

Compact design for tough use.

Easy in-feed, easy cutting and precise, right angle cut.

Sturdy telescopic spindle, long spindle guide, cutting wheel on needle bearing and 2 specially hardened counter pressure rollers on needle bearings. Three high-molecular plastic guide rollers each on both sides, arranged triangularly for straight guidance of the corrugated metal hose (corrugated pipe) during the cutting process.

Ergonomically designed, comfortable rotary handle.

Specially hardened cutter wheel in approved, tough-hard REMS die-steel quality ensures a long service life. Cutter wheel protected against touching the back pressure rollers by in-feed limitation.



e.g.
Armaflex,
BANIDES,
Boagaz,
Chuchu Decayeux,
Clesse,
Eurotis,
FlexiPipe,
Gastite,
Gurtner

German Quality Products



Info



Supply format

REMS RAS W INOX 10–32/40 S. Pipe cutter for corrugated metal hoses (corrugated pipes) of stainless steel, also jacketed. Counter pressure rollers on needle bearings. With cutting wheel, on needle bearing. In blister pack.

Pipes	Art.-No.
$\text{DN } 10 - 32 (40) / \frac{3}{8} - 1\frac{1}{2}'' (2'')$	113450

Accessories

Description	Art.-No.
REMS cutter wheel W INOX 10–32/40 S on needle bearings	113461



REMS cutter wheels

German Quality Products
For REMS pipe cutters and other makes

Specially hardened cutter wheels in approved, tough-hard REMS die steel, ensure a long service life. German Quality Products.

REMS cutter wheels also fit in suitable pipe cutters of other makes, see table with dimensional data.

REMS cutter wheel	Material	Wall thickness	to fit following pipe cutters	Capacity Ø	Art.-No.
St ½–4", s 8	Steel pipes	s ≤ 8 mm	REMS RAS St ½–2" REMS RAS St 1¼–4"	½–2" 1¼–4"	341614
St 1–4", s 12	Steel pipes	s ≤ 12.5 mm	REMS RAS St 1¼–4"	1¼–4"	381622
Cu-INOX 3–120, s 4	Copper tubes, stainless steel tubes	s ≤ 4 mm	REMS RAS Cu-INOX 3–16 REMS RAS Cu-INOX 3–28 REMS RAS Cu-INOX 3–35 REMS RAS Cu-INOX 3–42 REMS RAS Cu-INOX 6–42 REMS RAS Cu-INOX 6–64 REMS RAS Cu-INOX 64–120 REMS RAS Cu 3–35 REMS RAS Cu 3–42	3–16 mm 3–28 mm 3–35 mm 3–42 mm 6–42 mm 6–64 mm 64–120 mm 3–35 mm 3–42 mm	113210
Cu-INOX 3–120 S, s 4, on needle bearings	Copper tubes, stainless steel tubes	s ≤ 4 mm	REMS RAS Cu-INOX 3–28 S REMS RAS Cu-INOX 3–35 S REMS RAS Cu-INOX 8–64 S	3–28 mm 3–35 mm 8–64 mm	113213
Cu-INOX b 3, s 4	Copper tubes, stainless steel tubes	s ≤ 4 mm	See table "Dimensional data for REMS cutter wheels"		113220
Cu 3–120, s 3	Copper tubes	s ≤ 3 mm	REMS RAS Cu-INOX 3–16 REMS RAS Cu-INOX 3–25 REMS RAS Cu-INOX 3–28 REMS RAS Cu-INOX 3–35 REMS RAS Cu-INOX 3–42 REMS RAS Cu-INOX 6–42 REMS RAS Cu-INOX 6–64 REMS RAS Cu-INOX 64–120 REMS RAS Cu 3–16 REMS RAS Cu 3–25 REMS RAS Cu 3–28 REMS RAS Cu 3–35 REMS RAS Cu 3–42 REMS RAS Cu 8–42 REMS RAS Cu 8–64	3–16 mm 3–25 mm 3–28 mm 3–35 mm 3–42 mm 6–42 mm 6–64 mm 64–120 mm 3–16 mm 3–25 mm 3–28 mm 3–35 mm 3–42 mm 8–42 mm 8–64 mm	113225
P 10–40, s 4,5	Plastic pipes, composite tubes	s ≤ 4,5 mm	REMS RAS P 10–32 T REMS RAS P 10–40 T	10–32 mm 10–40 mm	290023
P 10–63, s 7	Plastic pipes, composite tubes	s ≤ 7 mm	REMS RAS P 10–40 REMS RAS P 10–63	10–40 mm 10–63 mm	290016
P 50–315, s 11	Plastic pipes, composite tubes	s ≤ 11 mm	REMS RAS P 50–110 REMS RAS P 110–160 REMS RAS P 180–315	50–110 mm 110–160 mm 180–315 mm	290116
P 50–315, s 16	Plastic pipes, composite tubes	s ≤ 16 mm	REMS RAS P 50–110 REMS RAS P 110–160 REMS RAS P 180–315	50–110 mm 110–160 mm 180–315 mm	290216
P 50–315, s 19	Plastic pipes, composite tubes	s ≤ 19 mm	REMS RAS P 50–110 REMS RAS P 110–160 REMS RAS P 180–315	50–110 mm 110–160 mm 180–315 mm	290316
W INOX 10-32/40 S, on needle bearings	Corrugated metal hoses (corrugated pipes) of stainless steel		REMS RAS W INOX 10-32/40 S	DN 10–32 (40)	113461

German Quality Products

Dimensional data for REMS cutter wheels



REMS cutter wheel	Art.-No.	OD mm	W mm	ID mm
St ½–4", s 8	341614	32.30	18.94	9.04
St 1–4", s 12	381622	41.30	18.94	9.04
Cu-INOX 3–120, s 4	113210	19.70	4.93	5.00
Cu-INOX 3–120 S, s 4	113213	19.70	4.93	5.00
Cu-INOX b 3, s 4	113220	18.70	3.07	4.80
Cu 3–120, s 3	113225	18.70	4.93	5.00
P 10–40, s 4,5	290023	20.50	4.93	5.00
P 10–63, s 7	290016	25.20	5.97	6.00
P 50–315, s 11	290116	35.30	10.95	8.00
P 50–315, s 16	290216	45.30	10.95	8.00
P 50–315, s 19	290316	51.30	10.95	8.00
W INOX 10-32/40 S	113461	26.60	4.93	5.00

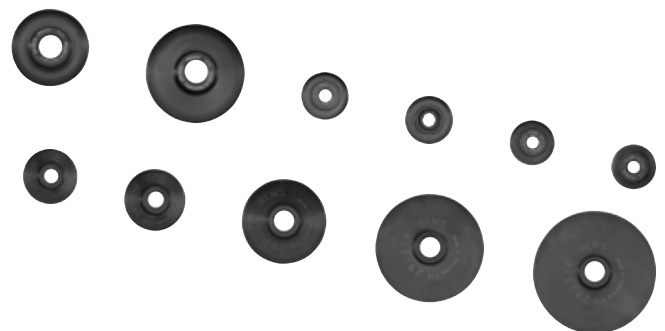

Powerful, handy electric tool for cutting pipe and tubing. For trade and industry. For the building site and the workshop.

Stainless steel pipes of pressfitting systems, carbon steel, copper	Ø 12 – 28 mm Ø 10 – 35 mm
Multilayer composite pipes	Ø 10 – 40 mm

REMS Nano – cutting up to Ø 40 mm.
Ultra-light. Fast. Right angled. Chip-free.
Without outer burr. Dry.

Ideal for pressfitting systems

Right angled cutting, according to requirements

Chip-free, no chips in piping system

No outer burr, no damage to O-ring by outer burr

Dry cutting, no damage to O-rings from lubricants

Fast, prevents degradation of pipe material through overheating.

Design

Mobile, electric pipe cutting machine for fast, right angled cutting without outer burr. Handy and light, only 1.9 kg. Also for fixing to the workbench or in the vice. Strong, torsion-free aluminium structure for right angled cutting. Easy cutting of the pipes by specially designed cutter wheel. Powered cutter wheel for fast cutting. Energy-saving in-feed due to ergonomically designed pressing lever. Cutter wheel protected against touching the back pressure rollers by in-feed limitation.

Pipe support

3 sturdy, specially arranged counter-pressure rollers made of hardened precision steel for low-friction turning and safe guidance of the pipes to be cut in the whole working range Ø 10 – 40 mm and for optimisation of the contact points of the cutting wheel on the pipe to be cut (**Patent EP 2 077 175**). No setting.

Drive

Robust gear precisely mounted in ball and needle bearings, maintenance-free. Proven DC motor 230 V, 130 W. Powerful. e.g. copper pipe Ø 22 mm in only 3 s. Ideal speed 130 rpm for optimum cutting speed of the pipes. Safety switch.

REMS cutter wheels

Top German quality. Cutter wheels specially designed to the performance capability of the REMS Nano and for numerous pipe materials with variable cutting geometries for fast cutting with no outer burr. Specially hardened, from proven, through-hardened REMS die-steel, ensuring long service life.



German Quality Product



Info

Supply format

REMS Nano Basic-Pack. Electric pipe cutting machine for fast, right angled cutting of pipes Ø 10 – 40 mm, without outer burr. For pipes of the press fitting systems made of stainless steel, carbon steel, Ø 12 – 28 mm, copper Ø 10 – 35 mm. Multilayer composite tubes Ø 10 – 40 mm. With maintenance-free gear, proven DC motor 130 V, 50 – 60 Hz, 200 W. Speed 130 rpm. Back pressure rollers made of hardened precision steel. Safety switch. Single open ended wrench size 8. Without cutter wheel. In carrying bag.

	Art.-No.	
	844010	



Accessories

Description	Art.-No.	
REMS cutter wheel Cu-INOX for stainless steel pipes of pressfitting systems, copper, carbon steel	844050	
REMS cutter wheel V for multilayer composite pipes	844051	
Carrying bag	574436	
L-Boxx system case with inlay for REMS Nano/ Nano 11 V, rapid charger, battery, REMS REG 8 – 35, 2 x REMS cutter wheels, metre rule	844045	
REMS Jumbo , folding workbenches, see page 106.		
REMS Herkules , material supports, see page 107.		

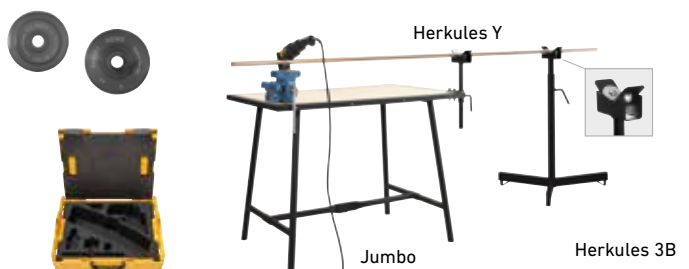

REMS Nano 11 V

Cordless pipe cutter

Powerful, mobile, handy electric tool for cutting pipe and tubing. For trade and industry. For the building site and the workshop.

Stainless steel pipes of pressfitting systems, carbon steel, copper	Ø 12–28 mm Ø 10–35 mm
Multilayer composite pipes	Ø 10–40 mm

REMS Nano 11 V – cutting up to Ø 40 mm. Mobile, handy, ultra-light. Fast. Right angled. Chip-free. Without outer burr. Dry.

Ideal for pressfitting systems

Right angled cutting, according to requirements

Chip-free, no chips in piping system

No outer burr, no damage to O-ring by outer burr

Dry cutting, no damage to O-rings from lubricants

Fast, prevents degradation of pipe material through overheating.

Design

Mobile, battery-powered pipe cutting machine for fast, right angled cutting without outer burr. Handy and light, only 2.1 kg. Also for fixing to the workbench or in the vice. Strong, torsion-free aluminium structure for right angled cutting. Easy cutting of the pipes by specially designed cutter wheel. Powered cutter wheel for fast cutting. Energy-saving in-feed due to ergonomically designed pressing lever. Cutter wheel protected against touching the back pressure rollers by in-feed limitation.

Pipe support

3 sturdy, specially arranged counter-pressure rollers made of hardened precision steel for low-friction turning and safe guidance of the pipes to be cut in the whole working range Ø 10–40 mm and for optimisation of the contact points of the cutting wheel on the pipe to be cut (**Patent EP 2 077 175**). No setting.

Drive

Robust, precision ball and needle bearing gears, maintenance-free. Powerful battery motor 10.8 V, with large power reserve, 270 W output. Super fast, e.g. copper pipe Ø 22 mm in just 3 s. Ideal speed 130 rpm for optimum cutting speed of the pipes. Safety switch.

Li-Ion technology

Battery Li-Ion 10.8 with 2.5 Ah capacity. Light and powerful. High energy density for many cuts. Overheating and overloading protection by temperature monitor (NTC). Rapid charger 220–240 V, 10.8–18 V, 65 W, for short charging times. No memory effect for maximum battery performance.

REMS cutter wheels

Top German quality. Cutter wheels specially designed to the performance capability of the REMS Nano 11 V and for numerous pipe materials with variable cutting geometries for fast cutting with no outer burr. Specially hardened, from proven, through-hardened REMS die-steel, ensuring long service life.



German Quality Product



Info

Supply format

REMS Nano 11 V Basic-Pack. Electric pipe cutting machine for fast, right angled cutting of pipes Ø 10–40 mm, without outer burr. For pipes of the press fitting systems made of stainless steel, carbon steel, Ø 12–28 mm, copper Ø 10–35 mm. Multilayer composite tubes Ø 10–40 mm. With maintenance-free gear, powerful battery motor 10.8 V, 270 W. Speed 130 rpm. Safety switch. Battery Li-Ion 10.8 V, 2.5 Ah, rapid charger 220–240 V, 50–60 Hz, 10.8–18 V, 65 W. Counter pressures rollers made of hardened precision steel. Single open ended wrench size 8. Without cutting wheel. In carrying bag.

	Art.-No.	
	844011	

Accessories

Description	Art.-No.
REMS cutter wheel Cu-INOX for stainless steel pipes of pressfitting systems, copper, carbon steel	844050
REMS cutter wheel V for multilayer composite pipes	844051
Battery Li-Ion 10.8 V, 2.5 Ah	844510
Rapid charger 220–240 V, 50–60 Hz, 10.8–18 V, 65 W	571560
Carrying bag	574436
L-Boxx system case with inlay for REMS Nano/ Nano 11 V, rapid charger, battery, REMS REG 8–35, 2x REMS cutter wheels, metre rule	844045
REMS Jumbo , folding workbenches, see page 106.	
REMS Herkules , material supports, see page 107.	



Light, portable compact machine. Universal for cutting and deburring pipes. For trade and industry. For the building site and the workshop.

Stainless steel pipes of pressfitting systems, carbon steel, copper	Ø 8 – 108 mm
Steel pipes EN 10255 (DIN 2440)	DN 6 – 100 Ø ½ – 4", Ø 10 – 115 mm
Cast iron pipes (SML) EN 877 (DIN 19522)	DN 50 – 100
Plastic pipes SDR 11	
Wall thickness $s \leq 10$ mm	Ø 10 – 110 mm Ø ½ – 4"
Multilayer composite pipes	Ø 10 – 110 mm
REMS Cento RF Set	
Welded drain pipe/down pipe made of stainless steel (EN 1124)	Ø 40 – 110 mm

REMS Cento – Cutting and deburring up to Ø 115 mm. Super fast. Right angled. Chip-free. No outer burr. Dry cutting.

Universal for many pipe types.

Ideal for pressfitting systems

Right angled cutting, according to requirements
Chip-free, no chips in piping system
No outer burr, no damage to O-ring by outer burr
Dry, no damage to the O-ring by coolants-lubricants.
Fast, prevents degradation of pipe material through overheating.

Design

Compact, mobile pipe cutting machine for fast, right angled, cutting with no outer burr. Handy and light, only 16.8 kg. Stable, distortion-free cast construction for right angled cutting. Easy pipe-cutting through specially designed cutter wheel. Powered cutter wheel and linear advance for fast cutting (**Patent EP 1 782 904**). Power saving feed-in through easy to grip, proven advance-lever and needle bearing mounted machine screw spindle. Cutter wheel protected – as movement restricted to before any contact with the rollers. Connection for driving outer/inner pipe deburrer REMS REG 10 – 54 E. For workbench, stand or wheel stand as an accessory, for easy transport, optimum working height and stable positioning. An alternative feed lever is available for operating the drive unit on the floor, see accessories.

Running rollers

4 strong hardened precision tubular steel running rollers on ball bearings for low-friction turning of the pipes Ø 22 – 115 mm, Ø ¾ – 4" to be cut, trapezoidally arranged, replaceable. No setting work required in the whole working range Ø 22 – 115 mm. Stainless tubular steel rollers as accessory. Cutting of pipes Ø 8 – 22 mm by placing two pipe sections Ø 28 x 220 mm on the running rollers. REMS Cento RF with 4 sturdy polyamide rollers mounted on ball bearings, to avoid damage to the pipe surfaces, for low-friction rotation of the welded drain pipes/downpipes of stainless steel (EN 1124) Ø 40 – 110 mm to be cut; pipe guides Ø 75 and 110 mm prevent the pipe from becoming oval shaped.

Drive

Robust gear, precisely mounted in roller and needle bearings, maintenance-free. Proven universal motor, 1200 W. Powerful, e.g. stainless steel pipe Ø 54 mm in just 4 s. Ideal speed 115 rpm for optimum cutting speed of the pipes. Safety foot-switch with emergency stop.

REMS cutter wheels

Top German quality. Cutter wheels specially designed to the performance capability of the REMS Cento and for numerous pipe materials with variable cutting geometries for fast cutting with no outer burr. Specially hardened, from proven, through-hardened REMS die-steel, ensuring long service life.

Pipe support

Pipe support, height adjustable, for pipes Ø 40 – 110 mm, Ø 1½ – 4", with operation of the drive unit with feed lever on the floor. Easy moving of the material in all directions when turning, pulling and pushing by four stainless steel balls mounted in a rust-protected housing. Safe guiding of long pipes by use of several pipe supports.

REMS pipe deburrer

Inner pipe deburrer REMS REG 28 – 108 for pipes Ø 28 – 108 mm, Ø ¾ – 4", with circulating friction element on the deburrer housing (**Patent EP 2 500 122**) for electrical rotary drive by the cutting wheel of the REMS Cento, REMS Cento 22V pipe cutting machine, as an accessory. Outer/inner pipe deburrer REMS REG 10 – 54 E for pipes Ø 10 – 54 mm, Ø ½ – 2½", for electric drive with the REMS Cento, REMS Cento 22V pipe cutting machines, see page 101.

Marking device

Marking device for marking the insertion depth for fittings on pipes, as an accessory.

Patent EP 1 782 904

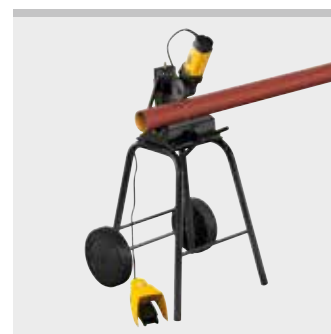
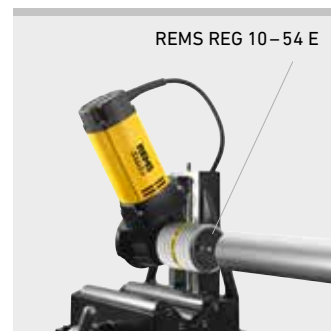

German Quality Product



Info

Supply format

REMS Cento Basic. Pipe cutting machine for fast, right angled, cutting of pipes with no outer burr Ø 8–115 mm. For pipes of the press fitting systems made from stainless steel, carbon steel, copper, Ø 8–108 mm. For steel pipes EN 10255 (DIN 2440) DN 6–100, Ø ½–4", Ø 10–115 mm, cast pipes (SML) EN 877 (DIN 19522) DN 50–100, plastic tubes SDR 11, wall thickness $s \leq 10$ mm, Ø 10–110 mm, Ø ½–4", composite tubes Ø 10–110 mm. With maintenance-free gear, proven universal motor 230 V or 110 V, 50–60 Hz, 1200 W. Speed 115 rpm. Rollers in hardened precision steel pipe for pipes Ø 22–115 mm, Ø ¾–4". Safety foot-switch. Ring spanner. Without cutter wheel. For workbench, stand or wheel stand. In a carton.

	Art.-No.	
	845001	

Other voltages on request.



Supply format

REMS Cento RF Set. Pipe cutting machine especially for fast, right-angled cutting of welded drain pipes/down pipes made of stainless steel (EN 1124) Ø 40–110 mm. As Art. No. 845001, but with rollers made of polyamide and pipe guides Ø 75 and 110 mm. Safety foot switch. Ring spanner. With cutting wheel RF. For workbench, stand or wheel stand. In a carton.

	Art.-No.	
	845003	

Other voltages on request.



Accessories

Description	Art.-No.	
Feed lever with spring plug for operating the drive unit on the floor (for drive units manufactured from 2014 onwards).	845218	
REMS cutter wheel Cu-INOX for stainless steel pipes of pressfitting systems, copper, carbon steel	845050	
REMS cutter wheel Cu specially for pipes of copper pressfitting systems	845053	
REMS cutter wheel St for steel pipes, cast iron pipes (SML)	845052	
REMS cutter wheel V for plastic and multilayer composite pipes, wall thickness $s \leq 10$ mm	845051	
REMS cutting wheel C-SF especially for pipes of the pressfitting systems and push fitting systems made from carbon steel, simultaneously produces a chamfer.	845055	
REMS cutting wheel RF for cutting welded drain pipes/down pipes made of stainless steel (EN 1124) with REMS Cento RF.	845054	
Pipe support 1 , height adjustable, for pipes Ø 40–110 mm, Ø ½–4", with operation of the drive unit with feed lever on the floor	845220	
Hardened, precision tubular steel rollers (pack of 4)	845118	
Stainless tubular steel INOX rollers (pack of 4)	845110	
Polyamide roller (pack of 4)	845131	
Marking device for marking the insertion depth for fittings on pipes. For REMS Cento, REMS Cento 22V.	845530	
REMS REG 10–54 E , outer/inner pipe deburrer, see page 101		
REMS REG 28–108 , inner pipe deburrer for pipes Ø 28–108 mm, Ø ¾–4", for electric rotary drive by the cutting wheel of the REMS Cento, REMS Cento 22V pipe cutting machine (with REMS cutting wheel Art. No. 845050 or 845053).	113840	
Stand	849315	
Wheel stand	849310	
REMS Jumbo , folding workbenches, see page 106.		
REMS Herkules , material supports, see page 107.		



Patent EP 2 500 122

REMS Cento 22V

Cordless pipe cutting machine

Light, mobile compact machine. Universal for cutting and deburring pipes. For trade and industry. For the building site and the workshop. Li-Ion 22V Technology. For battery and corded operation.

Stainless steel pipes of pressfitting systems, carbon steel, copper	Ø 8–108 mm
Steel pipes EN 10255 (DIN 2440)	DN 6–100 Ø ½–4", Ø 10–115 mm
Cast iron pipes (SML) EN 877 (DIN 19522)	DN 50–100
Plastic pipes SDR 11	
Wall thickness $s \leq 10$ mm	Ø 10–110 mm Ø ½–4"
Multilayer composite pipes	Ø 10–110 mm

REMS Cento 22V – Mobile cutting and deburring up to Ø 115 mm. Super fast. Right angled. Chip-free. No outer burr. Dry cutting. Li-Ion 22V Technology. Li-Ion 21.6V, 5.0Ah battery, for approx. 280 stainless steel pipe sections of the Ø 22 mm press fitting systems with one battery charge*.

Universal for many pipe types.

Ideal for pressfitting systems

- Right angled cutting**, according to requirements
- Chip-free**, no chips in piping system
- No outer burr**, no damage to O-ring by outer burr
- Dry**, no damage to the O-ring by coolants-lubricants.
- Fast**, prevents degradation of pipe material through overheating.

Design

Compact, mobile cordless pipe cutting machine for fast, right angled, cutting with no outer burr. Handy and light, drive unit with battery only 17.6 kg. Stable, distortion-free cast construction for right angled cutting. Easy pipe-cutting through specially designed cutter wheel. Powered cutter wheel and linear advance for fast cutting (Patent EP 1 782 904). Power saving feed-in through easy to grip, proven advance-lever and needle bearing mounted machine screw spindle. Cutter wheel protected – as movement restricted to before any contact with the rollers. Practical handle for easy transport. Connection for driving outer/inner pipe deburrer REMS REG 10–54 E. For workbench, stand or wheel stand as an accessory, for easy transport, optimum working height and stable positioning. An alternative feed lever is available for operating the drive unit on the floor, see accessories.

Running rollers

4 strong hardened precision tubular steel running rollers on ball bearings for low-friction turning of the pipes Ø 22–115 mm, Ø ¾–4" to be cut, trapezoidally arranged, replaceable. No setting work required in the whole working range Ø 22–115 mm. Stainless tubular steel rollers as accessory. Cutting of pipes Ø 8–22 mm by placing two pipe sections Ø 28 x 220 mm on the running rollers.

Drive

Robust gear, precisely mounted in roller and needle bearings, maintenance-free. Powerful 21.6 V battery motor, e.g. stainless steel pipe Ø 54 mm in just 7 s. Ideal speed 84 rpm for optimum cutting speed of the pipes. Machine status check with overload protection of the drive unit against too high currents, with overheating protection by motor temperature monitoring (NTC), with electronic battery charging status check with charging level indication by a 2-coloured green/red LED. Safety foot-switch with emergency stop.

Battery or mains operation

Li-Ion 22V Technology. Highly resistant Li-Ion 21.6V battery with 4.4, 5.0 or 9.0 Ah capacity, for long service life. Light and powerful. Li-Ion 21.6V, 4.4Ah battery for approx. 246 stainless steel pipe sections, 5.0Ah battery for approx. 280 stainless steel pipe sections, 9.0Ah for approx. 520 stainless steel pipe sections of the Ø 22mm press fitting systems with one battery charge*. Graduated charging status check by coloured LEDs. Operating temperature range – 10 to + 60 °C. No memory effect for maximum battery power. Rapid charger 100–240V, 90W. Rapid charger 100–240V, 290W, for shorter charging times, as accessory. Voltage supply 220–240V/21.6V, 40A output, for mains operation instead of Li-Ion battery 21.6 V, as accessory.

REMS cutter wheels

Top German quality. Cutter wheels specially designed to the performance capability of the REMS Cento 22V and for numerous pipe materials with variable cutting geometries for fast cutting with no outer burr. Specially hardened, from proven, through-hardened REMS die-steel, ensuring long service life.

Pipe support

Pipe support, height adjustable, for pipes Ø 40–110 mm, Ø 1½–4", with operation of the drive unit with feed lever on the floor. Easy moving of the material in all directions when turning, pulling and pushing by four stainless steel balls mounted in a rust-protected housing. Safe guiding of long pipes by use of several pipe supports.

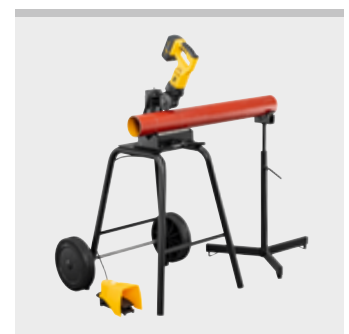
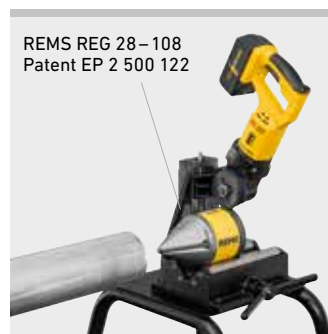
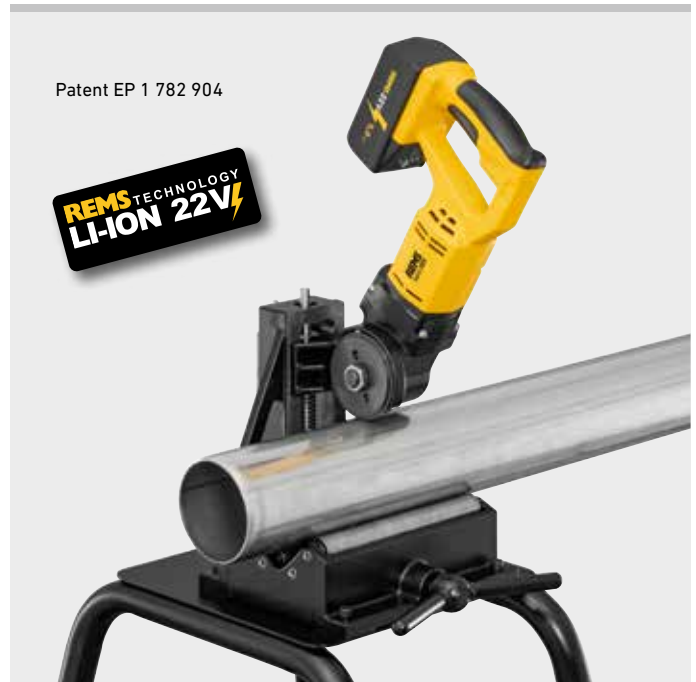

German Quality Product



Info

REMS pipe deburrer

Inner pipe deburrer REMS REG 28–108 for pipes Ø 28–108 mm, Ø ¾–4", with circulating friction element on the deburrer housing (**Patent EP 2 500 122**) for electrical rotary drive by the cutting wheel of the REMS Cento, REMS Cento 22V pipe cutting machine, as an accessory. Outer/inner pipe deburrer REMS REG 10–54 E for pipes Ø 10–54 mm, Ø ½–2½", for electric drive with the REMS Cento, REMS Cento 22V pipe cutting machines, see page 101.

Marking device

Marking device for marking the insertion depth for fittings on pipes, as an accessory.

Supply format

REMS Cento 22V Basic. Cordless pipe cutting machine for fast, right angled, cutting of pipes with no outer burr Ø 8–115 mm. For pipes of the press fitting systems made from stainless steel, carbon steel, copper, Ø 8–108 mm. For steel pipes EN 10255 (DIN 2440) DN 6–100, Ø ½–4", Ø 10–115 mm, cast pipes (SML) EN 877 (DIN 19522) DN 50–100, plastic tubes SDR 11, wall thickness $s \leq 10$ mm, Ø 10–110 mm, Ø ½–4", composite tubes Ø 10–110 mm. With maintenance-free gear, powerful 21.6 V battery motor. Speed 84 rpm. Machine status check with overload protection, temperature monitoring, battery charging status check. Rollers in hardened precision steel pipe for pipes Ø 22–115 mm, Ø ¾–4". Safety foot-switch. Li-Ion 21.6V, 5.0Ah battery, 100–240V, 50–60 Hz, 90W rapid charger. Ring spanner. Without cutter wheel. For workbench, stand or wheel stand. In a carton.

	Art.-No.
	845002

Other voltages on request.

Accessories

Description	Art.-No.
Battery Li-Ion 21.6V, 4.4 Ah	571574
Battery Li-Ion 21.6V, 5.0 Ah	571581
Battery Li-Ion 21.6V, 9.0 Ah	571583
Rapid charger 100–240V, 50–60 Hz, 90W	571585
Rapid charger 100–240V, 50–60 Hz, 290W	571587
Voltage supply 220–240V/21.6V, 50–60 Hz, 40A, for mains operation instead of battery Li-Ion 21.6V	571578
Feed lever with spring plug for operating the drive unit on the floor.	845218
REMS cutter wheel Cu-INOX for stainless steel pipes of pressfitting systems, copper, carbon steel	845050
REMS cutter wheel Cu specially for pipes of copper pressfitting systems	845053
REMS cutter wheel St for steel pipes, cast iron pipes (SML)	845052
REMS cutter wheel V for plastic and multilayer composite pipes, wall thickness $s \leq 10$ mm	845051
REMS cutting wheel C-SF especially for pipes of the pressfitting systems and push fitting systems made from carbon steel, simultaneously produces a chamfer.	845055
Pipe support 1 , height adjustable, for pipes Ø 40–110 mm, Ø 1½–4", with operation of the drive unit with feed lever on the floor	845220
Hardened, precision tubular steel rollers (pack of 4)	845118
Stainless tubular steel INOX rollers (pack of 4)	845110
Marking device for marking the insertion depth for fittings on pipes. For REMS Cento, REMS Cento 22V.	845530
REMS REG 10–54 E , outer/inner pipe deburrer, see page 101	
REMS REG 28–108 , inner pipe deburrer for pipes Ø 28–108 mm, Ø ¾–4", for electric rotary drive by the cutting wheel of the REMS Cento, REMS Cento 22V pipe cutting machine (with REMS cutting wheel Art. No. 845050 or 845053).	113840
Stand	849315
Wheel stand	849310
REMS Jumbo , folding workbenches, see page 106.	
REMS Herkules , material supports, see page 107.	
REMS Lumen 2800 22V , cordless LED flood light, see page 111	

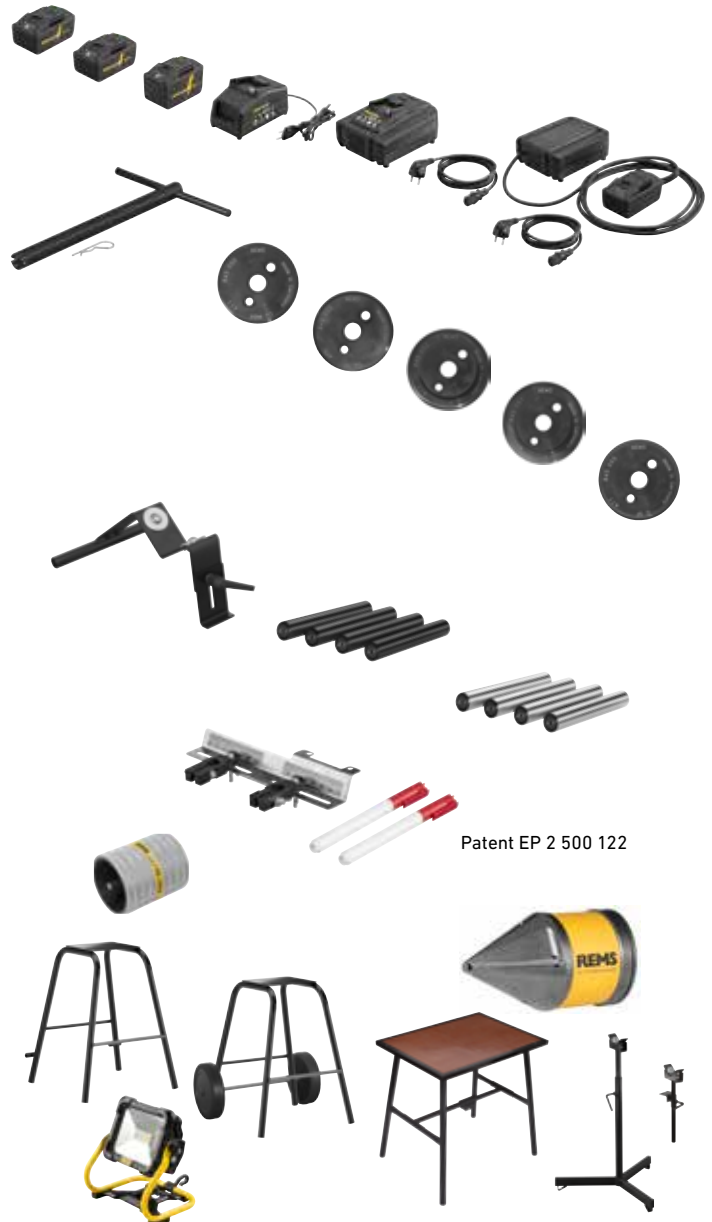

Patent EP 2 500 122

* Ambient temperature approx. 20°C.

Robust, mobile compact machine. Universal for cutting pipes. For trade and industry. For the building site and the workshop.

Stainless steel pipes of pressfitting systems, carbon steel, copper	Ø 54–225 mm
Steel pipes EN 10255 (DIN 2440)	DN 40–150 Ø 1½–6"
Cast iron pipes (SML) EN 877 (DIN 19522)	DN 50–200
Plastic pipes SDR 11	
Wall thickness $s \leq 21$ mm	Ø 40–225 mm
Multilayer composite pipes	Ø 40–110 mm

REMS DueCento – Cutting up to Ø 225 mm.
Right angled. Chip-free. Ready for welding. Fast.
No outer burr. Dry cutting.

Universal for many pipe types.

Right angled cutting, according to requirements

Chip-free, no chips in the pipe system, no dust

Weldable, for muff and butt welds

Fast, without impairment of the pipe material by overheating

Without outside burr, easy insertion into connecting muffs

Dry cutting, without impairment by coolant lubricants

Design

Compact, mobile pipe cutting machine for fast, right angled, cutting with no outer burr. Handy and easily transportable, only 37 kg. Stable, distortion-free cast construction for right angled cutting. Easy pipe-cutting through specially designed cutter wheel. Powered cutter wheel and linear advance for fast cutting (**Patent EP 1 782 904**). Power saving feed-in through easy to grip, proven advance-lever and needle bearing mounted machine screw spindle. Cutter wheel protected – as movement restricted to before any contact with the rollers. Practical chassis with two rubber tyred wheels for easy transport.

Running rollers

4 strong hardened precision tubular steel running rollers on ball bearings for low-friction turning of the pipes to be cut, arranged in convex square for centred thrust pressure of the cutting wheel in the working range Ø 100–225 mm, Ø 4–6", without setting work (**Patent EP 2 740 556**). Roller insert for cutting pipes Ø 40–110 mm, Ø 1½–4", as an accessory.

Drive

Robust gear, precisely mounted in roller and needle bearings, maintenance-free. Proven universal motor, 1200 W. Powerful, e.g. plastic tube PE Ø 225 mm in just 15 s. Ideal speed 115 rpm for optimum cutting speed of the pipes. Safety foot-switch with emergency stop.

REMS cutter wheels

Top German quality. Cutter wheels specially designed to the performance capability of the REMS DueCento and for numerous pipe materials with variable cutting geometries for fast cutting with no outer burr. Specially hardened, from proven, through-hardened REMS die-steel, ensuring long service life.

Pipe supports

Pipe supports, height adjustable, for pipes Ø 40–110 mm, Ø 1½–4" and Ø 100–225 mm, Ø 4–8". Easy moving of the material in all directions when turning, pulling and pushing by four stainless steel balls mounted in a rust-protected housing. Safe guiding of long pipes by use of several pipe supports.

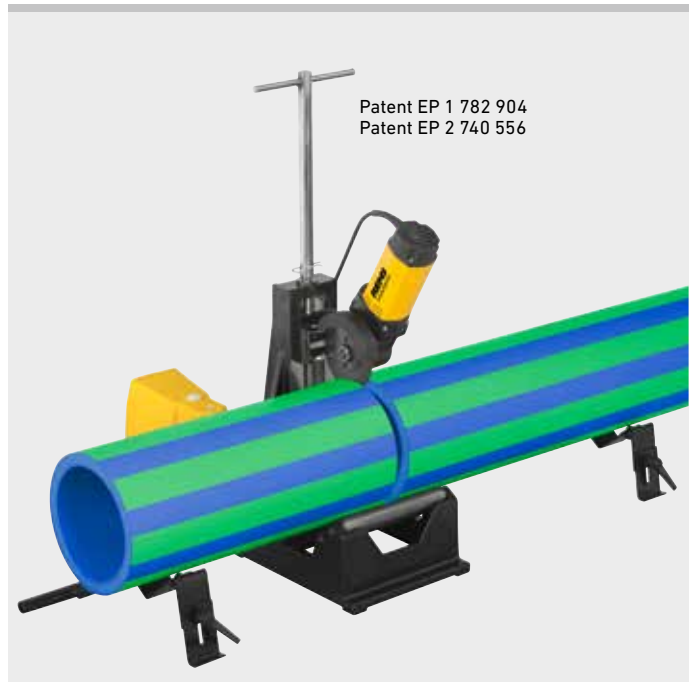

German Quality Product



Info

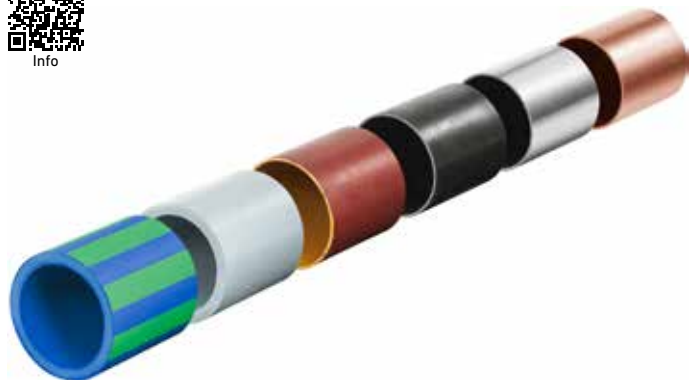

Supply format

REMS DueCento Basic. Pipe cutting machine for fast, right angled cutting of pipes \varnothing 40–225 mm, without outside burr. For pipes of the press fitting systems made from stainless steel, carbon steel, copper, \varnothing 54–225 mm. For steel pipes EN 10255 (DIN 2440) DN 40–150, \varnothing 1½–6", cast pipes (SML) EN 877 (DIN 19522) DN 50–200, plastic tubes SDR 11, wall thickness $s \leq 21$ mm, \varnothing 40–225 mm, \varnothing 1½–8", composite tubes \varnothing 40–110 mm. With maintenance-free gears, proven universal motor 110 / 230 V, 50–60 Hz, 1,200 W. Speed 115 rpm. Hardened, precision tubular steel rollers for pipes \varnothing 100–225 mm, \varnothing 4–6". Safety foot switch. Ring spanner. Without cutter wheel. 2 height adjustable pipe supports 1 for pipes \varnothing 100–225 mm, \varnothing 4–8". In a carton.

	Art.-No.	
	845004	

Other voltages on request.



Accessories

Description	Art.-No.	
REMS cutter wheel Cu-INOX for stainless steel pipes of pressfitting systems, copper, carbon steel	845050	
REMS cutter wheel Cu specially for pipes of copper pressfitting systems	845053	
REMS cutter wheel St for steel pipes, cast iron pipes (SML)	845052	
REMS cutting wheel C-SF especially for pipes of the pressfitting systems and push fitting systems made from carbon steel, simultaneously produces a chamfer.	845055	
REMS cutter wheel V, s 10 for plastic and multilayer composite pipes, wall thickness $s \leq 10$ mm	845051	
REMS cutter wheel P, s 21 for plastic and multilayer composite tubes, wall thickness $s \leq 21$ mm	845057	
Pipe support 1 , height adjustable for pipes \varnothing 100–225 mm, \varnothing 4–8"	845220	
Pipe support 2 , height adjustable, for pipes \varnothing 40–110 mm, \varnothing 1½–4" (roller insert required)	845230	
Roller insert for cutting pipes \varnothing 40–110 mm, \varnothing 1½–4"	845060	

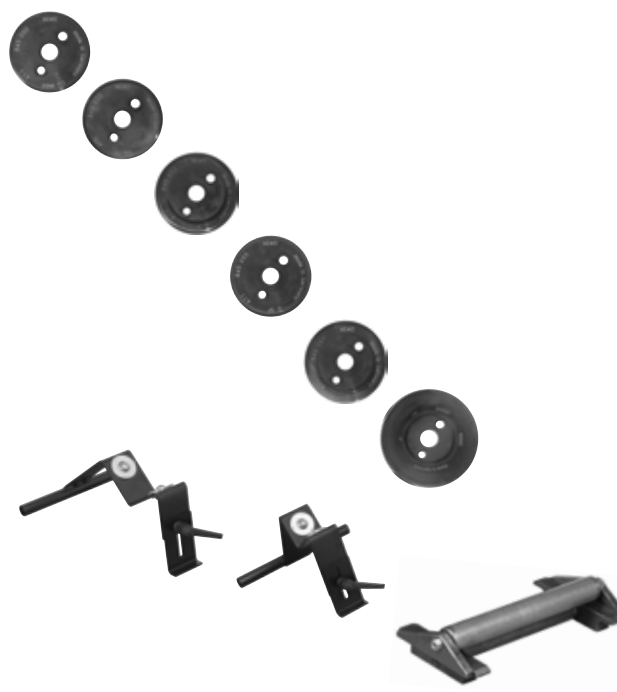

Robust quality tool for clean, fast cutting of pipes in one cut. Stable magnesium version. For one-hand operation.

Flexible plastic hoses,
soft plastic pipes $\leq \varnothing 28 \text{ mm}$
 $\leq \varnothing 1\frac{1}{8} \text{''}$

REMS ROS P flex – Fast cutting in one cut. Ideal for cutting flexible plastic hoses and soft plastic pipes.

Stable magnesium version, extremely light.

Ergonomically designed handles for fast cutting in one cut. For one-hand operation.

Blade drawback by spring-loaded articulated lever.

Specially hardened and specially ground, wedge-shaped blade with cutting angle of 110° , PTFE-coated. Ideal for cutting hoses and soft plastic pipes.

Right-angled, burr-free cutting by pipe rests on both sides and bilaterally clamped blade.

One-hand locking for safe transport and protection of the blade.

Chip-free cutting – no chips left in the pipe.

REMS ROS P flex 28 S with softgrip. Needle bearing-mounted articulated lever for easy cutting in one step.



Supply format

REMS ROS P flex. One-hand pipe shears for flexible plastic hoses and soft plastic pipes. With blade. In blister pack.

Description	Pipes $\leq \varnothing$ mm/inch	Art.-No.
P flex 14	14 $\frac{9}{16} \text{''}$	291400
P flex 22	22 $\frac{7}{8} \text{''}$	291410
P flex 28 S on needle bearings	28 $1\frac{1}{8} \text{''}$	291430

Accessories

Description	Art.-No.
Blade P flex 14 for REMS ROS P flex 14	291401
Blade P flex 22 for REMS ROS P flex 22	291411
Blade P flex 28 for REMS ROS P flex 28 S	291431



REMS ROS P 26/SW 35 S

One-hand pipe shears

Robust quality tool for clean, fast cutting of pipes in one cut. With integrated pipe cutter for protective corrugated tubes. Stable magnesium version. For one-hand operation.

Plastic tubes, composite tubes	≤ Ø 26 mm ≤ Ø 1"
Protective corrugated plastic tubes	Ø 18–35 mm Ø ¾–1⅜"

REMS ROS P 26/SW 35 S – Universal for many materials. Ideal for cutting composite pipes and PEX pipes. Fast cutting in one cut. With integrated pipe cutter for protective plastic corrugated tube.

Stable magnesium version, extremely light.

Ergonomically designed handles with softgrip for fast cutting in one cut. For one-hand operation.

Needle bearing-mounted articulated lever for easy cutting in one step.

Blade drawback by spring-loaded articulated lever.

One-hand locking for safe transport and protection of the blade.

Specially hardened and specially ground, rounded blade for low-wear working, PTFE-coated. 4 counter pressure rollers on needle bearings. For easy swivelling of the pipe shears during the cutting process. Ideal for cutting composite pipes, PEX pipes and similar.

Right-angled, burr-free cutting by extra-wide pipe rests on both sides and bilaterally clamped blade.

Cutting of protective corrugated pipes by 4 cutting tools at the end of the handle.

Three-edged, wedge-shaped cutting tools with a cutting angle of 120°, rotatable 3 times by 120° for three times longer life.

Cutting depth limiting of the cutting tools during cutting of corrugated protective pipes prevents damage to the inside of the pipe.

Chip-free cutting – no chips left in the pipe.

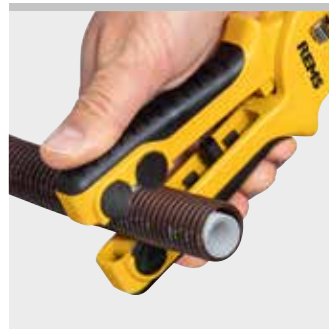
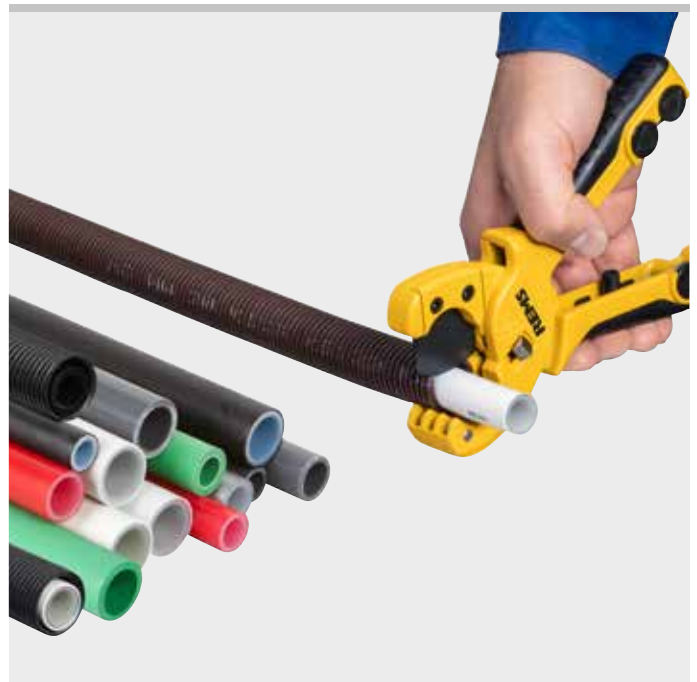

Info

Supply format

REMS ROS P 26/SW 35 S. One-hand pipe shears for plastic and composite pipes with integrated pipe cutter for plastic corrugated protective pipes. 4 counter pressure rollers on needle bearings. With blade and 4 cutting tools. In blister pack.

	Pipes ≤ Ø mm/inch	Art.-No.	
	P 26/1"	291242	
	SW 35/1⅜"		

Accessories

Description	Art.-No.	
Blade P 26/SW 35 for REMS ROS P 26/SW 35 S	291243	
Cutting tool P26/SW 35, pack of 4 for REMS ROS P 26/SW 35 S	291244	



REMS ROS P/PEX

One-hand pipe shears

Robust quality tool for clean, fast cutting of pipes in one cut. Stable magnesium version. For one-hand operation.

Plastic pipes, multilayer composite pipes $\leq \varnothing 26 \text{ mm}$
 $\leq \varnothing 1''$

REMS ROS P 26 – fast cutting in one cut.

Stable magnesium version, extremely light.

Ergonomically designed handles for fast cutting in one cut. For one-hand operation.

Blade drawback by spring-loaded articulated lever.

One-hand locking for safe transport and protection of the blade.

Specially hardened and specially ground blade, PTFE-coated.

Right-angled, burr-free cut by pipe rest on both sides and blade guided on both sides.

Chipless cutting – no chips remaining in pipe.



Info



Supply format

REMS ROS P 26. One-hand pipe shears for plastic and multilayer composite tubes. With blade. In blister pack.

	Pipes $\leq \varnothing$ mm/inch	Art.-No.	
	26		
	1"	291240	

Robust quality tool for clean, fast cutting of pipes in one cut. Stable magnesium version. For one-hand operation.

PEX pipes and similar $\leq \varnothing 28 \text{ mm}$
 $\leq \varnothing 1\frac{1}{8}''$

REMS ROS PEX 28 S – fast cutting in one cut. Ideal for cutting PEX pipes.

Stable magnesium version, extremely light.

Ergonomically designed handles with softgrip for fast cutting in one cut. For one-hand operation.

Needle bearing-mounted articulated lever for easy cutting in one step.

Blade drawback by spring-loaded articulated lever.

One-hand locking for safe transport and protection of the blade.

Specially hardened and specially ground, wedge-shaped blade with cutting angle of 150° for low-wear working, PTFE-coated. Ideal for cutting PEX pipes.

Right-angled, burr-free cut by pipe rest on both sides and blade guided on both sides.

Chipless cutting – no chips remaining in pipe.



Info



Supply format

REMS ROS PEX 28 S. One-hand pipe shears for PEX pipes, on needle bearing. With blade. In blister pack.

	Pipes $\leq \varnothing$ mm/inch	Art.-No.	
	28 / $1\frac{1}{8}''$	291420	

Accessories

Description	Art.-No.	
Blade P 26 for REMS ROS P 26	291241	
Blade PEX 28 for REMS ROS PEX 28 S	291421	



REMS ROS P

One-hand pipe shears with ratchet feed/
pipe shears with ratchet feed

Handy quality tools for clean, fast pipe cuts.
For thin-walled pipes also. Sturdy aluminium/
magnesium version. For single-hand operation.

Plastic pipes, multi-layer composite tubes ≤ Ø 63 mm
≤ Ø 2"

REMS ROS P 35 / ROS P 35 A / ROS P 42 / ROS P 42 PS / ROS P 42 S / ROS P 63 P / ROS P 63 S

Sturdy aluminium version, REMS ROS P 42 S and magnesium (Mg) version
P 63 S, ultra light.

Specially hardened, wedge-shaped blade, also for thin-walled pipes.

For single-hand operation. Effortless working through power transmitting
ratchet feed.

Quick reverse saves time and effort. REMS ROS P 35 A with automatic
quick reverse after completion of cutting.

Right angle, burr-free cut through exact pipe support and guided blade
on both sides.

Chipless cutting – no chips remaining in pipe.



Supply format

REMS ROS P. One-hand pipe shears for plastic pipes and multi-layer composite
tubes. With blade. In blister pack/in box.

Description	Pipes ≤ Ø mm/inch	Art.-No.
P 35	35	
with quick reverse	1 3/8"	291200
P 35 A	35	
with automatic quick reverse	1 3/8"	291220
P 42	42	
with quick reverse	1 5/8"	291250
P 42 PS	42	
with quick reverse	1 5/8"	291000
P 42 S	42	
with quick reverse	1 5/8"	291010
P 63 P	63	
with quick reverse	2"	291270
P 63 S	63	
with quick reverse	2"	291290

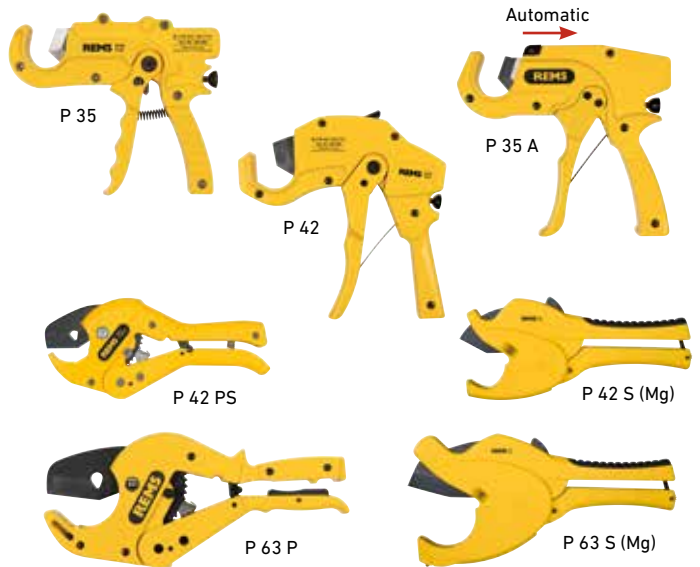

Robust quality tools for clean, fast pipe cuts.
Robust steel version.

Plastic pipes ≤ Ø 75 mm, ≤ Ø 2 1/2"

REMS ROS P 75 P

Robust steel version for rugged conditions and long life, with end stop for
powerful engagement, also ideal for thick-walled plastic pipes.

Rough, non-slip handle for good grip.

Specially hardened and specially ground, wedge-shaped blade with cutting angle
of 150° for low-wear working.

Fast, easy operation through guided ratchet on both sides and fine-toothed
ratchet gear, specially hardened.

Right angle, burr-free cut through two-point pipe support and guided blade
on both sides.

Chipless cutting – no chips remaining in pipe.



Supply format

REMS ROS P 75 P. Pipe shear for plastic pipes. With blade. In a carton.

Description	Pipes ≤ Ø mm/inch	Art.-No.
	75 / 2 1/2"	291101



Accessories

Description	Art.-No.
Blade P 35 for REMS ROS P 35	291201
Blade P 35 A for REMS ROS P 35 A	291221
Blade P 42 for REMS ROS P 42	291251
Blade P 42 PS for REMS ROS P 42 PS	291023
Blade P 42 S for REMS ROS P 42 S	291036
Blade P 63 P for REMS ROS P 63 P	291271
Blade P 63 S for REMS ROS P 63 S	291037
Blade P 75 P for REMS ROS P 75 P	291112

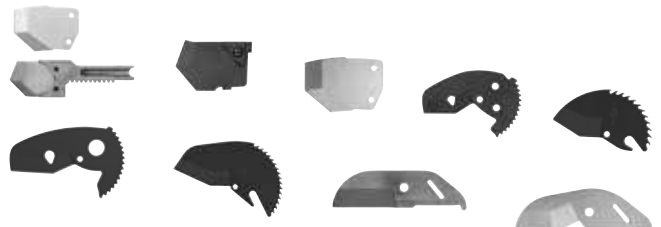

REMS Cut 110 P

Pipe cutting and pipe chamfering tool

Robust quality tool for right-angle, plain cutting and chamfering (15°) in one operation. Can be used anywhere, free-hand, on parallel vice or work bench.

Plastic pipes in
ABS, PB, PE, PE-HD, PE-X,
PP, PVC, PVDF

Ø 40 – 110 mm

REMS Cut 110 P – cutting and chamfering at the same time.

Robust metal design for tough use.

Cutting and chamfering in one operation. While turning the tool shaft, also cutting only possible.

Fast and easy to use, ergonomic clamping grip.

Spring loaded clamp inserts in plastic for concentric clamping of different pipe sizes. Easy to change without tools.

Steplessly adjustable clamping pressure accommodates pipe tolerances.

Cutting and chamfering tool in hard metal with optimum cutter geometry ensures precise cutting and chamfering. Long service life.

Holder for workbench for effortless operation.

Tool set Cu-INOX and clamp inserts for cutting welded rain gutter pipes in copper, titanium zinc, stainless steel, as accessory.



Supply format

REMS Cut 110 P Set. Pipe cutting and pipe chamfering tool for plastic pipes in ABS, PB, PE, PE-HD, PE-X, PP, PVC, PVDF, Ø 40 – 110 mm. Quick clamping device Ø 110 mm with 2 each of clamping inserts Ø 50 and 75 mm. Tool set P with cutting and chamfering blade P, s 11. In sturdy case.

Description	Art.-No.
Set 50 + 75 + 110	290400



Accessories

Description	Pipes Ø mm	Art.-No.
Clamping inserts (pack of 2)	40	290420
	50	290421
	52	290422
	56	290444
	58	290423
	60	290445
	63	290427
	75	290424
	76	290446
	78	290425
	80	290447
	87	290448
	90	290426
100	290449	
Tool set P		
with cutting and chamfering blade P, s 11		290432
Cutting and chamfering blade P, s 11		290430
Cutting and chamfering blade P, s 15.5		290431
Tool set Cu-INOX		
with cutter wheel Cu-INOX 3 – 120, s 4		290433
REMS cutter wheel Cu-INOX 3 – 120, s 4		113210
Holder for work bench		290440
Case		290437

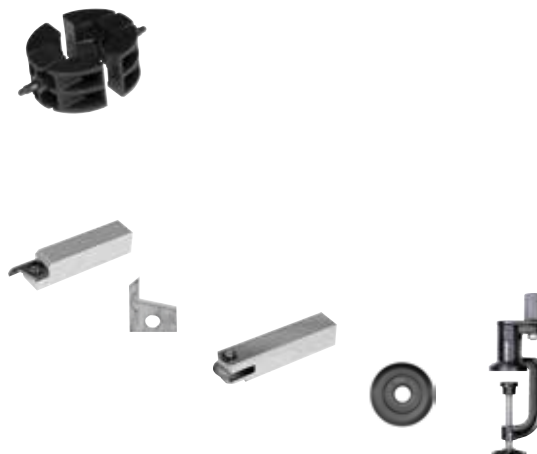

REMS Cut 110 Cu-INOX

Pipe cutting tool

Robust quality tool for right-angle cutting of welded pipe. Can be used anywhere, free-hand, on parallel vice or work bench.

Welded copper drainpipe/downpipe,
Titanium zinc, stainless steel (EN 1124) Ø 50–110 mm

REMS Cut 110 Cu-INOX – Easy cutting of downpipes.

Robust metal design for tough use.

Fast and easy to use, ergonomic clamping grip.

Spring loaded clamp inserts in plastic for concentric clamping of different pipe sizes. Easy to change without tools.

Steplessly adjustable clamping pressure accomodates pipe tolerances.

Cutting and chamfering tool in hard metal with optimum cutter geometry ensures precise cutting and chamfering. Long service life.

Holder for workbench for effortless operation.

Tool set P and clamp inserts for right-angle, plain cutting and chamfering (15°) of plastic pipe, as accessory, see page 96.



Supply format

REMS Cut 110 Cu-INOX Set. Pipe cutter for welded drainpipes/downpipes made of copper, titanium zinc, stainless steel (EN 1124), Ø 50–110 mm. Quick action clamp Ø 110 mm with clamp inserts. Tool set Cu-INOX with cutter wheel Cu-INOX 3–120, s 4. In sturdy case.

Description	Art.-No.
Set 50 + 75 + 110	290412
Set 60 + 80 + 100 + 110	290410
Set 76 + 87 + 100 + 110	290411



Accessories

Description	Art.-No.
Clamp inserts , see page 96.	
Tool set Cu-INOX with cutter wheel Cu-INOX 3–120, s 4	290433
REMS cutter wheel Cu-INOX 3–120, s 4	113210
Holder for work bench	290440



Handy quality tools for simple and fast external chamfering (15°) of pipes.

Plastic pipes \varnothing 16 – 250 mm, \varnothing 3/4 – 10"

Wall thickness \leq PN 16

REMS RAG – chamfering at 15°.

Chamfering at 15° on commonly used plastic pipes.

Also suited for deburring plastic pipes. Ensures easy joining of sleeves to be welded.

Easily adjusted for pipe diameter and wall thickness.

Very fast and easy chamfering due to a particularly favourable cutting geometry of the chamfering blades.

Two adjacent, identical chamfering blades, one of which cuts the chamfer and the other one serves as a support for the pipe during chamfering. If the cutting chamfering blade is worn, it can be exchanged with the support part, for double the service life.

Easy-to-slide V-block with two different bevel angles for good guidance of small pipe sizes. In high-grade, glass-fibre reinforced polyamide.



German Quality Product



Supply format

REMS RAG. Pipe chamfering tool for plastic pipes. With blades. In a carton.

Description	Pipes \leq \varnothing mm/inch	Art.-No.
P 16 – 110	16 – 110 / 3/4 – 4"	292110
P 32 – 250	32 – 250 / 1 1/4 – 10"	292210

Accessories

Description	Art.-No.
Chamfering blades (pack of 2) for REMS RAG P 16–250	292011



REMS REG Universal

Universal deburrer

Universal quality tool for deburring tubes and edges of different materials.

Copper, steel, brass, aluminium, plastic.

REMS REG Universal – the all-purpose deburrer.

Robust metal design for tough use.

Easy handling and good grip thanks to ergonomically designed hexagon handle.

Rotating universal deburrer blade in handle accommodates to the work piece edge to be deburred.

Specially hardened and specially ground universal deburrer blade guarantees easy deburring and long service life.

Fast, simple blade replacement by pulling back the front sliding sleeve.

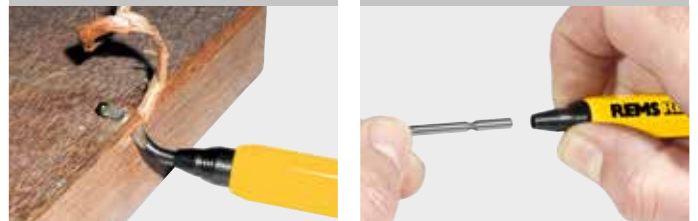

Supply format

REMS REG Universal. Universal deburrer. For copper, steel, brass, aluminium, plastic. On cardboard.

	Art.-No.	
	113910	

Accessories

Description	Art.-No.	
Universal deburring blade, ground	113360	

REMS REG St ¼ – 2"

Inner pipe deburrer

Robust quality tool for inner pipe deburring.

For electric operation.

Steel pipes and other pipes Ø ¼ – 2"

REMS REG St ¼ – 2": effortless electric deburring.

Inner pipe deburrer with octagonal attachment head for operating by means of electric die stocks with octagonal seat, e.g. REMS Amigo E, REMS Amigo, REMS Amigo 2, REMS Amigo 2 Compact.

Specially hardened and designed deburring blade ensures easy deburring and extremely long life. Double edges for optimum chip flow, specially for small sizes.



German Quality Product



Supply format

REMS REG St ¼ – 2". Inner pipe deburrer for electric operation. For steel pipes and other pipes, Ø ¼ – 2". In a carton.

	Art.-No.	
	731700	

REMS REG 3 – 35

Outer-inner tube deburrer

Sturdy manual tool for outer-inner tube deburring.

Copper, brass, aluminium, steel, plastic tubes

Ø 3 – 35 mm
Ø 1/8 – 1 3/8"

REMS REG 3 – 35 – the sharp edge.

Fast, effortless deburring through 3 specially hardened and ground deburring blades.

Robust housing in shock-proof, resistant plastic.



German Quality Product

Supply format

REMS REG 3 – 35. Outer-inner tube deburrer. For copper, brass, aluminium, steel, plastic tubes, Ø 3 – 35 mm, Ø 1/8 – 1 3/8". In blister pack.

	Art.-No.	
	113900	

REMS REG 8 – 35

Outer-inner pipe deburrer

Robust quality tool for removing outer and inner burr from pipes.

Stainless steel pipes, other steel pipes, copper, brass, aluminium, plastic pipes

Ø 8 – 35 mm
Ø 3/8 – 1 3/8"

REMS REG 8 – 35 – the multiple edge up to Ø 35 mm.

Easy, effortless deburring through multiple blades which are specially hardened and ground.

Robust metal design for tough use.



Supply format

REMS REG 8 – 35. Outer-inner pipe and tube deburrer. For stainless steel pipes, other steel pipes, copper, brass, aluminium, plastic pipes, Ø 8 – 35 mm, Ø 3/8 – 1 3/8". In blister pack.

	Art.-No.	
	113825	

REMS REG 10 – 42

Outer-inner pipe deburrer

Robust, solid all-metal tool for outer-inner pipe and tube deburring. For manual or electric operation.

Stainless steel pipes, other steel pipes, copper, brass, aluminium, plastic pipes

Ø 10 – 42 mm
Ø 1/2 – 1 5/8"

REMS REG 10 – 42 – by hand or electric. Specially for stainless steel pipes.

Ideal for pipes of all types. Specially for stainless steel tubes of pressfitting systems.

Easy and fast deburring through an appropriate, solid all-metal tool, equipped with 4 specially hardened and ground deburring blades

Driver for electrical drive by REMS Helix 22V VE cordless drill/screwdriver (page 108) and other power drills/screwdrivers (speed ≤ 300 rpm), as an accessory.



German Quality Product



Supply format

REMS REG 10 – 42. Outer-inner pipe and tube deburrer for manual or electric operation. For stainless steel pipes, other steel pipes, copper, brass, aluminium, plastic pipes, Ø 10 – 42 mm, Ø 1/2 – 1 5/8". Without adapter for electric drive. In blister pack.

	Art.-No.	
	113810	

Accessories

Description	Art.-No.	
Adapter for REMS REG 10 – 42	113815	
REMS Helix 22V VE, cordless drill/screwdriver, see page 108		



REMS REG 10 – 54

Outer-inner pipe deburrer

Robust quality tool for removing outer and inner burr from pipes.

Stainless steel pipes, other steel pipes, copper, brass, aluminium, plastic pipes

Ø 10 – 54 mm
Ø ½ – 2 1/8"

REMS REG 10 – 54 – the multiple edge up to Ø 54 mm.

Easy, effortless deburring through multiple blades which are specially hardened and ground.
Robust metal design for tough use.

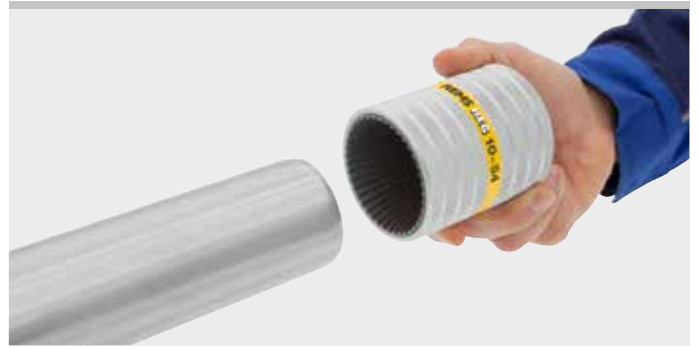

Supply format

REMS REG 10 – 54. Outer-inner pipe and tube deburrer. For stainless steel pipes, other steel pipes, copper, brass, aluminium, plastic pipes, Ø 10 – 54 mm, Ø ½ – 2 1/8". In blister pack.

	Art.-No.	
	113830	

REMS REG 10 – 54 E

Outer-inner pipe deburrer

Robust quality tool for removing outer and inner burr from pipes. For manual operation or electric drive.

Stainless steel pipes, other steel pipes, copper, brass, aluminium, plastic pipes

Ø 10 – 54 mm
Ø ½ – 2 1/8"

REMS REG 10 – 54 E – by hand or electrically. Especially for stainless steel pipes.

Easy, effortless deburring through multiple blades which are specially hardened and ground.

Integrated hexagonal driver for electrical drive by REMS Helix 22V VE cordless drill/screwdriver (page 108) and other power drills/screwdrivers with 1/4" bit holders (speed ≤ 300 rpm), by the REMS Cento or REMS Cento 22V pipe cutting machine (page 86 – 89) and by the REMS Turbo Cu-INOX pipe circular sawing machine (page 72) (**Patent EP 2 058 067**).

Robust metal design for tough use.



Supply format

REMS REG 10 – 54 E. Outer-inner pipe and tube deburrer for manual or electric operation. For stainless steel pipes, other steel pipes, copper, brass, aluminium, plastic pipes, Ø 10 – 54 mm, Ø ½ – 2 1/8". In blister pack.

	Art.-No.	
	113835	

Accessories

Description
REMS Helix 22V VE , cordless drill/screwdriver, see page 108
REMS Cento , pipe cutting machine, see page 86
REMS Cento 22V , cordless pipe cutting machine, see page 88
REMS Turbo Cu-INOX , pipe circular sawing machine, see page 72



Assembling

	Water pump pliers	104
	Pipe workstation Chain pipe vices	105
	Folding workbenches	106
	Material supports	107
	Cordless power drill/screwdriver	108
	Electric LED flood light Cordless LED flood light	110

REMS Catch S

Swedish pattern wrench 'S'

Rugged quality tools for tough use and long service life.
All-steel, drop forged.

Swedish model according to DIN 5234 - Form C.

Pipes ≤ Ø 3"
Nuts, bolts, flat material

REMS Catch S – for professional use.

Swedish model with S-shaped jaws for secure 3-point grip.
Self-locking thus secure gripping and holding even on smooth pipes.
Rugged design in chrome-vanadium steel, all steel, drop forged, tempered, powder-coated. Hardened, highly wear resistant toothing.
Ergonomically shaped handle, slip-proof. Stop prevents jamming.
Adjusting nut cannot be lost. Reinforced sleeve.

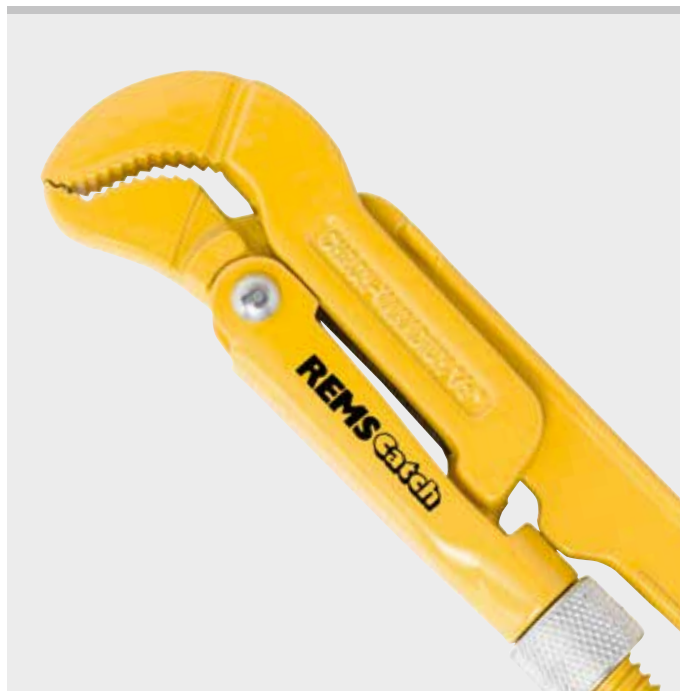

Supply format

REMS Catch S. Swedish pattern wrench 'S'. DIN 5234 – Form C.
In plastic bag.

Description Pipes ≤ Ø inch	Width mm	Art.-No.
S ½"	36	116000
S 1"	47	116005
S 1½"	60	116010
S 2"	78	116015
S 3"	112	116020



REMS Catch W

Water pump pliers

Rugged quality tools for tough use and long service life.
All-steel, drop forged.

According to ISO 8976 with box joint.

Pipes ≤ Ø 1½"
Square, hexagonal joints, flat material

REMS Catch W – for professional use.

Gripping pliers with reinforced, ground, box joint. 7 grip positions.
Self-locking thus secure gripping and holding, even on smooth pipes.
Rugged design in chrome-vanadium steel, all-steel, drop forged, tempered, powder-coated. Hardened, highly wear resistant toothing.
Ergonomically shaped handle, slip-proof. Stop prevents jamming.



Supply format

REMS Catch W. Water pump pliers, 7 grip positions. ISO 8976.
In plastic bag.

Description	Pipes ≤ Ø inch	Art.-No.
W 175	1"	116050
W 240	1¼"	116055
W 300	1½"	116060



REMS Aquila 3B

Portable pipe workstation with chain pipe vice

Sturdy, easy to carry pipe workstation with integrated chain pipe vice on folding tripod stand. With practical shelf plate. For trade and industry. For the building site and the workshop.

Clamping range	Ø 10 – 165 mm Ø 1/8 – 6"
Load capacity	≤ 450 kg

REMS Aquila 3B – portable pipe workstation. Safe clamping of pipes up to 6". Everywhere on site.

Sturdy, torsion-free die-cast structure of the work plate with integrated chain pipe vice, pipe rest, tool holders, 3 benders for bending pipes Ø 10 – 26 mm, Ø 3/8 – 3/4", clamping head.

Specially toothed double clamping jaws, easily changeable, prism-shaped, for safe clamping of the pipes in the whole working range. Specially hardened, for long life.

Clamping chain with strong chain links, easy clamping by quick closure and trapezoidal threaded spindle.

Well accessible working range in front of the chain pipe vice for free swing of even long tools.

Especially suitable for pipe installation, e.g. for cutting, thread cutting, bending, assembly.

Adjustable clamping head for clamping the pipe workstation between the ceiling and the floor, for especially secure standing.

Proven tripod stand for secure standing, folding, for easy erection and transport. Practical shelf plate for tools and work material.

REMS Herkules height adjustable material supports (see page 107).



Info



Supply format

REMS Aquila 3B. Pipe workstation with chain pipe vice for clamping pipes, solid material Ø 10 – 165 mm, Ø 1/8 – 6". Work plate with integrated chain pipe vice with double clamping jaws, pipe rest, tool holders, 3 benders for bending pipes Ø 10 – 26 mm, Ø 3/8 – 3/4", clamping head. Folding tripod stand with shelf plate. Load capacity ≤ 450 kg. In a carton.

	Art.-No.	
	120270	

REMS Aquila WB

Chain pipe vice for workbench

High quality, robust chain pipe vice for fixing to a workbench. Excellent quality for long life. For trade and industry. For the building site and the workshop.

Clamping range	Ø 10 – 165 mm Ø 1/8 – 6"
----------------	-----------------------------

REMS Aquila WB – safe clamping of pipes up to 6".

Sturdy, torsion-free die-cast structure of the base plate with integrated chain pipe vice, pipe rest, bender.

Specially toothed double clamping jaws, easily changeable, prism-shaped, for safe clamping of the pipes in the whole working range. Specially hardened, for long life.

Clamping chain with strong chain links, easy clamping by quick closure and trapezoidal threaded spindle.

Well accessible working range in front of the chain pipe vice for free swing of even long tools.

Especially suitable for pipe installation, e.g. for cutting, thread cutting, bending, assembly.

For fixing to the workbench. Pay attention to load capacity of the workbench.

REMS Herkules height adjustable material supports (see page 107).



German Quality Product



Info



Supply format

REMS Aquila WB. High quality chain pipe vice for clamping pipes, solid material Ø 10 – 165 mm, Ø 1/8 – 6". Base plate with integrated chain pipe vice with double clamping jaws, pipe rest, bending device. For work bench. In a carton.

	Art.-No.	
	120250	

Sturdy, easy to carry folding workbenches for universal use. Worktop in accordance with DIN 68 705. For trade and industry. For the building site and the workshop.

REMS Jumbo E – handy and light.

Work top	Birch-Multiplex, 800 × 600 × 22 mm
Height	800 mm
Weight	23 kg
Load capacity	≤ 300 kg

REMS Jumbo – the indestructible folding workbench.

Handy and light. German quality product.

Work top	Beech-Multiplex, 1100 × 700 × 26 mm
Height	800 mm
Weight	28 kg
Load capacity	≤ 300 kg

REMS Jumbo – assembled and disassembled at lightning speed. With toggle catch. Worktops in accordance with DIN 68 705. Highly resistant up to 300 kg.

Handy and light. REMS Jumbo E only 23 kg, REMS Jumbo only 28 kg.

Worktop made of special Birch-Multiplex plywood (REMS Jumbo E) or Beech-Multiplex plywood (REMS Jumbo), in accordance with DIN 68 705 weather-proof glued, impregnated, vice-proof and tear-proof, flat and torsion-free.

Impact and splinter resistant thanks to steel edge protection. Screws and nuts galvanised,

Especially safe standing by strong tubular steel frame with toggle catch, assembled and disassembled at lightning speed. Easy to carry.

Highly resistant, max. load capacity 300 kg.



German Quality Product



Info



Supply format

REMS Jumbo. Folding workbench with toggle catch. Worktop in accordance with DIN 68 705. Load capacity ≤ 300 kg. In a carton.

Description	Work top	Size mm	Art.-No.
REMS Jumbo E	Birch-Multiplex	800 × 600	120240
REMS Jumbo	Beech-Multiplex	1100 × 700	120200

Vertically adjustable material support with roller guidance for rotating and stationary pipe and solid material. For trade and industry. For the building site and the workshop.

Pipes, solid material \varnothing (1/8) 3/4 – 6", \varnothing (6) 26 – 168 mm
Load capacity ≤ 150 kg

REMS Herkules – the sturdy support.

Easy moving of the material in all directions when turning, pulling and pushing by two stainless steel balls mounted in a rust-protected housing in the range \varnothing 3/4 – 6", \varnothing 26 – 168 mm.

Especially suitable for pipe installation, e.g. for cutting, thread cutting, roll grooving, welding, soldering.

Robust, job site-proven design. Dismantles for transport and stocking.

Optionally on safe standing tripod or with clamping device for workbench.

Height adjustable, REMS Herkules 3B from 690 to 1,180 mm from the floor, REMS Herkules Y from 35 to 580 mm from the workbench surface.

Supply format

REMS Herkules. Vertically adjustable material support for pipes, solid material \varnothing (1/8) 3/4 – 6", \varnothing (6) 26 – 168 mm. Optionally on tripod or with clamping device for workbench. Load capacity ≤ 150 kg. In a carton.

Description	Version	Art.-No.
REMS Herkules 3B	Tripod with protection caps	120120
REMS Herkules Y	Clamping fixture for work bench	120130



German Quality Product



Info

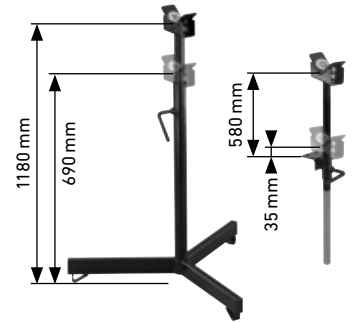

Height adjustable material support with ball guide for rotating and standing tubular and solid material. For trade and industry. For the building site and the workshop.

Pipes, solid material \varnothing (1/8) 1 1/4 – 12", \varnothing (6) 42 – 324 mm
Load capacity ≤ 450 kg

REMS Herkules XL 12" – extra stable for pipes up to 12".

Especially suitable for pipe installation, e.g. for roll grooving, cutting, thread cutting, welding, soldering.

Easy moving of the material in all directions when turning, pulling and pushing by two stainless steel balls mounted in a rust-protected housing in the range \varnothing 1 1/4 – 12", \varnothing 42 – 324 mm.

Robust, job site-proven design. Securely standing tripod, folds up for transport and storage.

Height adjustable from 505 to 915 mm from the floor.

Threaded spindle for simple alignment of the pipe, with fixing device.

Practical handle for easy transport.

Supply format

REMS Herkules XL 12". Height adjustable, fold-up for pipes, solid material \varnothing 1 1/4 – 12", \varnothing 42 – 324 mm. Load capacity ≤ 450 kg. In a carton.

	Art.-No.
	120125

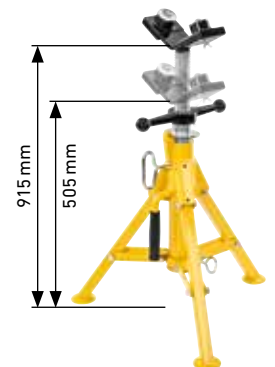

Powerful, mobile, handy power tool for drilling, driving in/loosening screws and deburring pipes. For assembly, disassembly, repair. Li-Ion 22V Technology. For battery and corded operation.

Drilling in steel, stone	≤ Ø 13 mm
Drilling in wood	≤ Ø 32 mm
Drilling with tile drills, e.g. in ceramic, fine clay, granite, marble	≤ Ø 14 mm
Driving in/loosening of screws	≤ Ø 8 mm

REMS Helix 22 V VE – drilling, screw riving and deburring. With powerful, brushless battery motor.

Design

Ultra light, ultra small, ultra handy. Drive machine with battery pack weighs only 1.6 kg. Can therefore be used everywhere, free hand, over head, also in very confined spaces. Optimum weight distribution for one-hand operation. Ergonomically designed housing. Drive machine with keyless quick chuck, clamping range 1.5–13 mm, right and left hand rotation. 2 continuously adjustable speed ranges from 0 to 560 rpm and 0 to 1,900 rpm, 15 torque stages plus drilling stage, hard torque of 50 Nm in both speed ranges, soft torque of 12 Nm in the fast and 30 Nm in the slow speed range for powerful screwdriving. Integrated LED work light for illuminating the work place. Belt clip. For cordless and mains operation. 1 bit with double blade slot/cross-head, 50 mm long. Bit set as accessory.

Drive

Powerful electro-mechanical drive with powerful, brushless battery motor 21.6V, 500W output, robust, 2-step, precision, ball bearing-mounted gear, maintenance-free. Safety switch.

Vario-Electronic

Continuous electronic speed control for gentle start drilling, driving in/loosening of screws and selection of the speed suitable for the material when drilling and driving in/loosening screws. The speed can be continuously controlled by variable pressure on the safety switch from 0 to 560 rpm or 0 to 1,900 rpm (accelerator switch (VE)).

Battery or mains operation

Li-Ion 22V Technology. Highly resistant Li-Ion 21.6V battery with 1.5, 4.4, 5.0 or 9.0Ah capacity, for long service life. Light and powerful. Graduated charging status check by coloured LEDs. Operating temperature range – 10 to + 60 °C. No memory effect for maximum battery power. Rapid charger 100–240V, 90W. Rapid charger 100–240V, 290W, for shorter charging times, as accessory. 220–240V/21.6V, 15A output, voltage supply for mains operation instead of Li-Ion battery 21.6V, as accessory.



Info

Supply format

REMS Helix 22 V VE Set. Cordless power drill/screwdriver with Vario-Electronics (VE) for drilling in steel, stone, $\leq \varnothing 13$ mm, wood $\leq \varnothing 32$ mm and other materials and for driving in/loosening screws $\leq \varnothing 8$ mm. Drive machine with keyless quick chuck, clamping range 1.5 – 13 mm, right and left hand rotation. Electromechanical drive with powerful, brushless battery motor 21.6 V, 500 W, 2-step robust gear. 2 continuously adjustable speed ranges from 0 to 560 rpm and 0 to 1,900 rpm, 15 torque stages plus drilling stage, hard torque of 50 Nm in both speed ranges. Safety switch. Integrated LED work light. Belt clip. Battery Li-Ion 21.6 V, 2.5 Ah, rapid charger 220–240 V or 110 V, 50–60 Hz, 70 W. 1 bit with double blade slot/cross-head, 50 mm long. In carrying bag.

	Art.-No.
	190110

Other voltages on request.



Accessories

Description	Art.-No.
REMS REG 10–42. Outer/inner pipe deburrer for pipes $\varnothing 10–42$ mm, $\varnothing \frac{1}{2}–1\frac{1}{8}$ ", see page 100	
REMS REG 10–54 E. Outer/inner pipe deburrer for pipes $\varnothing 10–54$ mm, $\varnothing \frac{1}{2}–2\frac{1}{8}$ ", see page 101	
REMS tile drilling, $\varnothing 5–14$ mm, see page 318	
REMS Helix 22 V VE drive unit, without battery	190100
Battery Li-Ion 21.6 V, 2.5 Ah	571571
Battery Li-Ion 21.6 V, 4.4 Ah	571574
Battery Li-Ion 21.6 V, 5.0 Ah	571581
Battery Li-Ion 21.6 V, 9.0 Ah	571583
Rapid charger 100–240 V, 50–60 Hz, 90 W	571585
Rapid charger 100–240 V, 50–60 Hz, 290 W	571587
Voltage supply 220–240 V/21.6 V, 50–60 Hz, 15 A, for mains operation instead of battery Li-Ion 21.6 V.	571567
Carrying bag	190053
Bit set, comprising quick-change bit holder, magnetic, with automatic bit lock, 12 bits (4 Torx, 3 cross-head PH, 3 cross-head PZ, 2 slotted), in practical magazine with elastic band for fixing to wrist or to the power tool.	190051
REMS Lumen 2800 22 V, cordless LED flood light, see page 111	



REMS Lumen 5000/7000/10000

Electric LED flood light

Powerful, electric LED flood light with high light intensity. For the building site and the workshop.

REMS Lumen 5000

Light flux 5000 lm

REMS Lumen 7000

Light flux 7000 lm

REMS Lumen 10000

Light flux brightness stage 1 5000 lm

Light flux brightness stage 2 10000 lm

REMS Lumen 5000/7000/10000 – electric lighting. With high light intensity. Handy, light. Continuous swivel.

Universal use

Powerful, mobile, electric LED flood light with high light intensity for universal use on the building site or in the workshop. REMS Lumen 10000 with 2 selectable brightness stages for any application purpose.

Design

Handy, light, electric LED flood light. REMS Lumen 5000 only 1.8 kg, REMS Lumen 7000 only 2.2 kg, REMS Lumen 10000 only 3.0 kg. Impact-resistant aluminium housing, dust-proof, protected against water jets from all directions. LEDs protected by impact-resistant, unbreakable acrylic glass. Flood light housing swivels through 360°, fixable by star grips, for optimum alignment of the light. On/Off switch. Tubular steel frame with rubber feet for a firm stand. Practical, non-slip handle. Practical, sturdy, telescopic tripod stand, only 1.9 kg, for accurate positioning of the LED flood light, adjustable height from 615 to 1,590 mm above floor level, collapsible for easy transport, as an accessory.

LED flood light

Modern, energy-saving LED flood light with high light intensity. Lights immediately without switch-on delay. Brightness of the LEDs in REMS Lumen 10000 selectable in 2 stages. 120° radiation angle for good illumination. Colour temperature 5,000 K. Efficient heat dissipation by high-quality, aluminium, ribbed heat sinks. Overheating regulates the power supply automatically, for continuous operation.

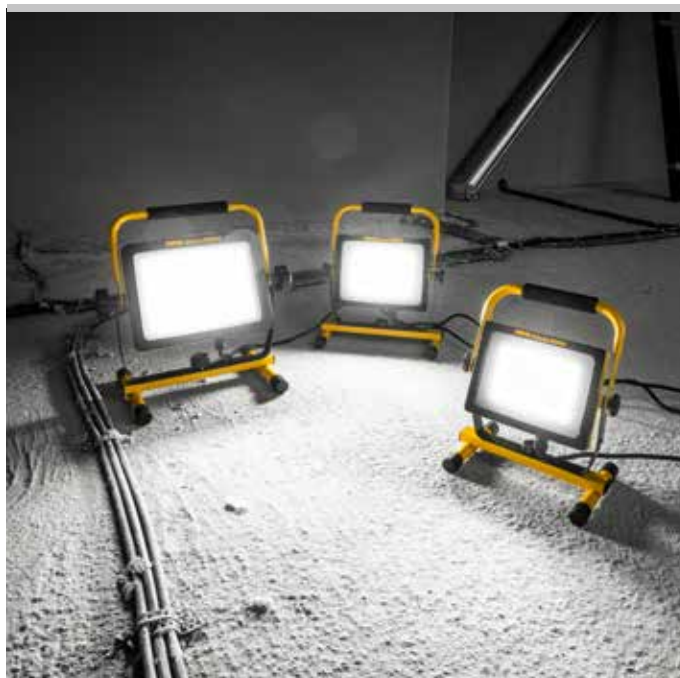

Info



Supply format

REMS Lumen. Electric LED flood light with high light intensity. 230V, 50–60 Hz. 5 m connecting lead. In a carton.

Description	Light flux ≤lm	Power ≤W	Art.-No.
Lumen 5000	5000	50	175220
Lumen 7000	7000	70	175221
Lumen 10000	10000	100	175222

Other voltages on request.

Accessories

Description	Art.-No.
REMS 3B telescopic stand, on a tripod, height-adjustable, collapsible	175230



REMS Lumen 2800 22V

Cordless LED flood light

Powerful, mobile cordless LED flood light with high light intensity. Li-Ion 22V Technology. For battery and corded operation. For the building site and the workshop.

Light flux brightness stage 1	1100 lm
Light flux brightness stage 2	2000 lm
Light flux brightness stage 3	2800 lm

REMS Lumen 2800 22V – lights everywhere. With high light intensity. Mobile, handy, light. For battery and corded operation. Continuous swivel.

Universal use

Powerful, mobile, cordless LED flood light with high light intensity for universal use on the building site or in the workshop. 3 selectable brightness stages, ideal for any application purpose.

Design

Handy, lightweight, cordless LED flood light, only 1.7 kg, with battery only 2.1 kg. Impact-resistant plastic housing. LEDs protected by impact-resistant, unbreakable acrylic glass. Flood light housing swivels through 360°, fixable by wing nuts, for optimum alignment of the light. On/Off switch. Tubular steel frame with plastic plate and pluggable hook, for fastening or hanging the flood light. Practical, non-slip handle. 220–240V, 50–60 Hz, 138 W power supply, for mains operation included. Holder for REMS Li-Ion 21.6 V integrated into the housing for cordless instead of mains operation. In cordless operation with Li-Ion 21.6V, 2.5 Ah, 54 Wh (output). Practical, sturdy, telescopic tripod stand, only 1.9 kg, for accurate positioning of the LED flood light, adjustable height from 615 to 1,590 mm above floor level, collapsible for easy transport, as an accessory.

LED flood light

Modern, energy-saving LED flood light with high light intensity. Lights immediately without switch-on delay. LED brightness selectable in 3 stages. 120° radiation angle for high illumination. Colour temperature 6,500 K. Efficient heat dissipation by high-quality, aluminium, ribbed heat sinks prevents overheating. For continuous operation.

Battery or mains operation

Li-Ion 22V Technology. Highly resistant Li-Ion 21.6V battery with 2.5, 4.4, 5.0 or 9.0Ah capacity, for long service life. Light and powerful. Graduated charging status check by coloured LEDs. Operating temperature range – 10 to + 60 °C. No memory effect for maximum battery power. Rapid charger 100–240V, 90 W. Rapid charger 100–240V, 290W, for shorter charging times, as accessory.



Description	Operating hours h*		
	Stage 1	Stage 2	Stage 3
Battery Li-Ion 21.6V, 2.5Ah	5.4	2.4	1.6
Battery Li-Ion 21.6V, 4.4 Ah	9.6	4.2	2.8
Battery Li-Ion 21.6V, 5.0Ah	10.9	4.8	3.2
Battery Li-Ion 21.6V, 9.0Ah	19.6	8.6	5.7

Supply format

REMS Lumen 2800 22V Set Power-Edition. Cordless LED flood light with high light intensity. For battery and corded operation. Light flux ≤ 2800 lm. Voltage supply 220–240V, 50–60 Hz, 138W. Without battery, without rapid charger. In a carton.

	Art.-No.
	175210

Other voltages on request.

Supply format

REMS Lumen 2800 22V Set. Cordless LED flood light with high light intensity. For battery and corded operation. Light flux ≤ 2800 lm. Battery Li-Ion 21.6V, 2.5 Ah, rapid charger 220–240V or 110 V, 50–60 Hz, 70 W. Voltage supply 220–240V, 50–60 Hz, 138W. In a carton.

	Art.-No.
	175211

Other voltages on request.



Accessories







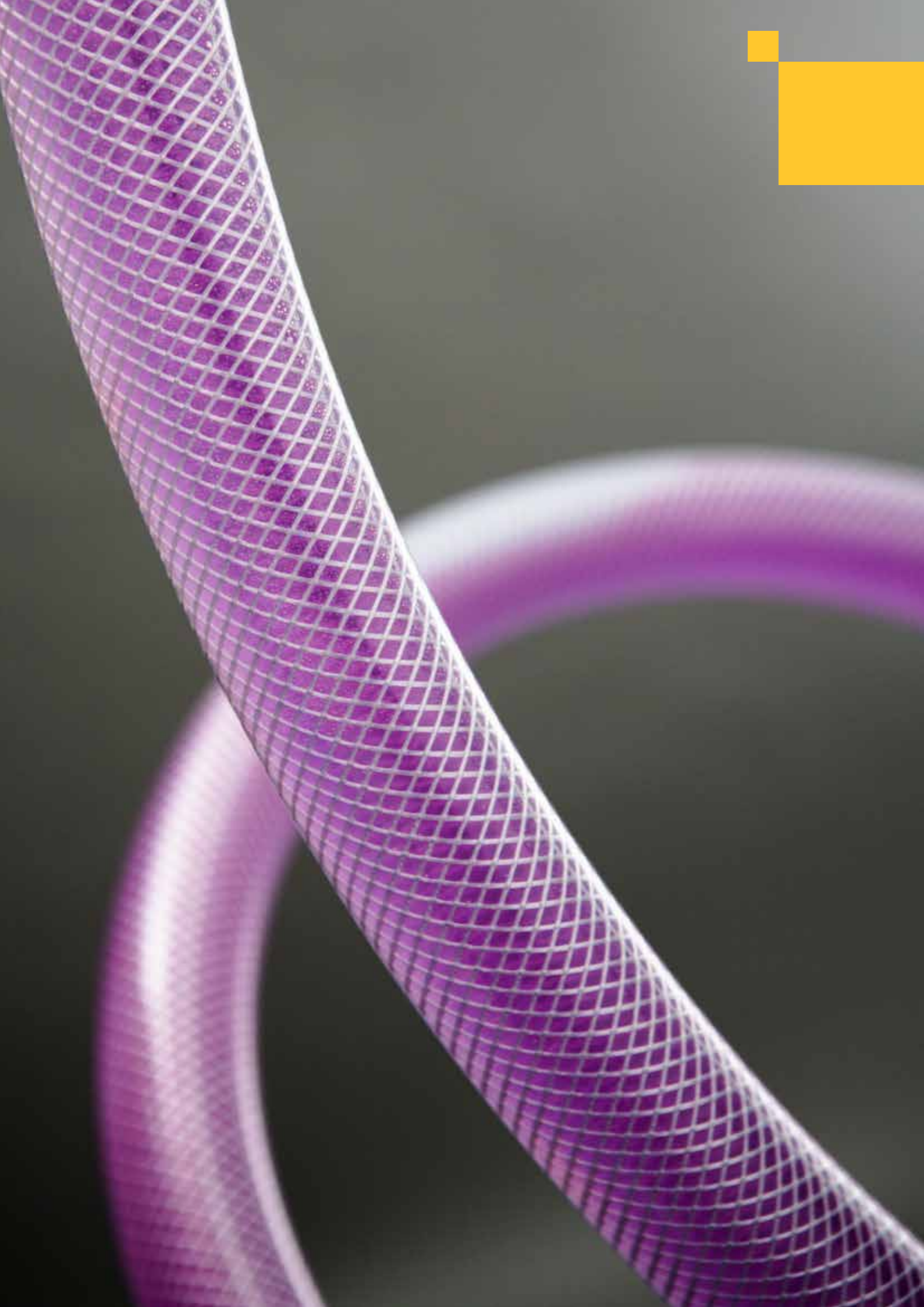

Description	Art.-No.
Battery Li-Ion 21.6V, 2.5 Ah	571571
Battery Li-Ion 21.6V, 4.4 Ah	571574
Battery Li-Ion 21.6V, 5.0 Ah	571581
Battery Li-Ion 21.6V, 9.0 Ah	571583
Rapid charger 100–240V, 50–60 Hz, 90W	571585
Rapid charger 100–240V, 50–60 Hz, 290W	571587
REMS 3B telescopic stand, on a tripod, height-adjustable, collapsible	175230



* Ambient temperature approx. 20°C.



Pressure testing
Cleaning
Disinfecting
Preserving
Flushing
Filling

	Hand pressure testing pump	114
	Electric pressure testing pump	115
	Electric decalcifying pump	116
	Electronic flushing unit with compressor	117
	Electronic flushing and pressure testing unit with compressor	120
	Disinfection unit TW, cleaning and preservation unit H	123
	Machine cleaner	123
	Electric filling and flushing unit	124

Proven, reliable testing pump for pressure and tightness tests of piping systems and receptacles.

Testing and pressure range	≤ 6 MPa/60 bar/870 psi
Water, oil, glycol	
pH-value of liquids	7–12
Temperature of liquids	≤ 60°C
Viscosity of liquids	≤ 1.5 mPa s

REMS Push – reliable pressure hold.

Universal use

For plumbing, heating, solar system and sprinkler installations, for compressed air, steam and cooling systems, oil installations, for boiler and pressure vessel building.

Design

Robust, job-site proven metal design for tough use. REMS Push with corrosion-resistant, powder-coated 12 ltr steel tank. Distortion resistant lever with ergonomic handle, doubles as carrying handle when locked. Wear resistant pressure piston in brass, Ø 30 mm. High-pressure hose with ½"-connection. Fine scale pressure gauge (accessory), p ≤ 1.6 MPa/16 bar/232 psi, for reading a pressure change of 0.01 MPa/0.1 bar/1.45 psi for tightness testing according to DIN 1988, as accessory.

Stainless steel tank

REMS Push INOX with 12 ltr stainless steel tank. For extremely long life.

Functioning

Pressure and tightness test with water or oil. Double valve system for reliable pressure built-up, with rust-proof steel balls. High pumping capacity with long stroke, fine pressure adjustment at short pushes. High pressure hose with fabric ply prevents measurement errors.



Info

Supply format

REMS Push. Hand pressure testing pump with pressure gauge, p ≤ 6 MPa/60 bar/870 psi, for pressure and tightness testing of piping systems and receptacles up to 6 MPa/60 bar/870 psi, Corrosion-resistant, powder-coated 12 ltr steel tank. 1.5 m high-pressure hose with ½"-connection. In a carton.

	Art.-No.
	115000

Supply format

REMS Push INOX. Hand pressure testing pump with pressure gauge, p ≤ 6 MPa/60 bar/870 psi, for pressure and tightness testing of piping systems and receptacles up to 6 MPa/60 bar/870 psi. 12 ltr stainless steel tank. 1.5 m high-pressure hose with ½"-connection. In a carton.

	Art.-No.
	115001



Accessories

Description	Pressure p ≤ MPa/bar/psi	Art.-No.
Connecting piece with pressure gauge and shut off valve	6/60/870	115110
Fine scale pressure gauge	1.6/16/232	115045

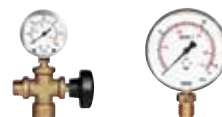

REMS E-Push 2

Electric pressure testing pump

Powerful, electric pressure testing pump for pressure and tightness tests of piping systems and receptacles.	
Testing and pressure range	≤ 6 MPa/60 bar/870 psi
Pumping capacity	6.5 l/min
Water, hydrous solutions, emulsions	
pH-value of liquids	7–10
Temperature of liquids	≤ 60°C
Viscosity of liquids	≤ 1.5 mPa s

REMS E-Push 2 – electric charging and testing. Up to 60 bar. With adjustable pressure limiting. 1300 W. Self sucking.

Universal use

In sanitary, heating, solar and sprinkler installation, for compressed air, steam and cooling systems, oil installations, in boiler and pressurised vessel construction.

Design

Robust, compact, light. Weighs only 10 kg. Easy to carry. Wear reduced high power piston pump. Pressure gauge, damped by filling with glycerine, $p \leq 6 \text{ MPa}/60 \text{ bar}/870 \text{ psi}$. High-pressure hose with fabric ply prevents measurement errors. Suction hose with suction filter. Non-return valve in the suction hose prevents the suction hose from running empty in standstill times; therefore shorter suction times. Suction hose and high pressure hose with $\frac{1}{2}$ "-connection. Connecting piece with pressure gauge, $p \leq 6 \text{ MPa}/60 \text{ bar}/870 \text{ psi}$, and shut off valve for pressure and tightness testing also after removal of the high pressure pump, e.g. theft protection or for use at several testing points, as accessory. Fine scale pressure gauge, $p \leq 1.6 \text{ MPa}/16 \text{ bar}/232 \text{ psi}$, for reading a pressure change of 0.01 MPa/0.1 bar/1.45 psi for tightness testing according to DIN 1988, as accessory.

High power piston pump

Self-sucking high power piston pump running in a sealed oil bath with wear reduced pressure piston in stainless steel. Proven, powerful capacitor motor, 1300 W, very powerful and fast. High pumping capacity of 6.5 l/min. Pressure and tightness testing up to 6 MPa/60 bar/870 psi.

Adjustable pressure limiting

Pressure limiting in 6 stages, 1–6 MPa/10–60 bar/145–870 psi, adjustable to the necessary pressure in the pipe system/tank.



Info



Supply format

REMS E-Push 2. Electric pressure testing pump with pressure gauge, $p \leq 6 \text{ MPa}/60 \text{ bar}/870 \text{ psi}$, for pressure and leak testing of pipe systems and tanks up to 6 MPa/60 bar/870 psi, with adjustable pressure limiting. Pump unit with capacitor motor 230 V, 50 Hz, 1300 W. 1.5 m suction hose with $\frac{1}{2}$ " connection and gaskets, suction filter with non-return valve. 1.5 m high-pressure hose with $\frac{1}{2}$ " connection and gaskets. In a carton.

	Art.-No.	
	115500	

Accessories

Description	Pressure $p \leq \text{MPa}/\text{bar}/\text{psi}$	Art.-No.
Connecting piece with pressure gauge and shut off valve	6/60/870	115110
Fine scale pressure gauge	1.6/16/232	115045

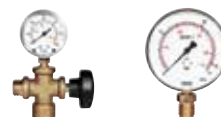

Powerful, electric decalcifying pump for effective decalcifying of pipes and containers, e.g. flow heaters, boilers, hot water tanks, cold water tanks, heat exchangers, heating and cooling systems.

Useful container volume	21 l
Displacement	≤ 30 l/min
Displacement pressure	≤ 0.1 MPa/1.0 bar/15 psi
Transport height	≤ 10 m
Temperature of decalcifying solution	≤ 50°C

REMS Calc-Push – effective electric decalcifying.
High displacement. 3-way lever for reversal of flow direction, with zero setting.

Universal use

For effective decalcifying of pipes and containers, e.g. flow heaters, boilers, hot water tanks, cold water tanks, heat exchangers, heating and cooling systems.

Design

Robust, compact, light, weights just 9.2 kg. Impact-proof plastic container for the decalcifying solution, useful container volume 21 l, with practical screw-on cap for closing the plastic container during transport. Flexible ½", 2.3 m long flexible PVC fabric hoses, with hose screw fittings with Rp ½" female thread and caps. 3-way lever for reversing the flow direction to remove even heavy lime deposits from both sides, with zero setting to interrupt the flow. Easy to carry due to centrally arranged handle with practical hose holders.

Unscrewable pump unit

Compact pump unit, consisting of a centrifugal pump and condenser motor, unscrewable, for easy cleaning of the pump unit and the plastic container after the decalcifying process. Self-sucking centrifugal pump, suitable for different decalcifying solutions of acetic acid, sulphuric acid, citric acid, formic acid, phosphoric acid, sulfamic acid. With proven, powerful condenser motor with quiet running, 165W, on/off switch. High displacement ≤ 30 l/min for effective decalcifying.



Supply format

REMS Calc-Push. Electric decalcifying pump for effective decalcifying of pipes and containers, e.g. flow heaters, boilers, hot water tanks, cold water tanks, heat exchangers, heating and cooling systems. Displacement ≤ 30 l/min, useful container volume 21 l. Pump unit with condenser motor 230V, 50 Hz, 165 W. Displacement pressure ≤ 0.1 MPa/1.0 bar/15 psi. Transport height ≤ 10 m. Flexible ½", 2.3 m long flexible PVC fabric hoses, with hose screw fittings with Rp ½" female thread and caps. 2 double nipples ¾" – ½", 2 double nipples ½" – ¾". In a carton.

	Art.-No.	
	115900	

Other voltages on request.



Powerful, compact, electronic flushing unit with oil-free compressor. For flushing with water or a water/air mixture, disinfection, cleaning, preservation of pipe systems and for operation of pneumatic tools.

Flushing and desilting

Water pressure pipe network $p \leq 1 \text{ MPa}/10 \text{ bar}/145 \text{ psi}$
 Pipe diameter installation $\leq \text{DN } 50, 2''$

Disinfection of drinking water installations

Cleaning and preservation of radiators and area heating systems

Water temperature $5 - 35^\circ\text{C}$

Water flow $\leq 5 \text{ m}^3/\text{h}$

Operation of pneumatic tools

Operating pressure $p \leq 0.8 \text{ MPa}/8 \text{ bar}/116 \text{ psi}$

Suction rate $\leq 230 \text{ NI}/\text{min}$

REMS Multi-Push S – Flushing with water or a water/air mixture. Easy switching of the air supply during the flushing process when desilting. Permanent process monitoring. Logging. USB interface.

Universal use

Only **one** device for flushing with water or a water/air mixture, disinfection, cleaning, preservation of pipe systems, e.g. for desilting, cleaning and preservation of radiators and area heating systems, flushing and disinfection of drinking water installations in accordance with EN 806-4:2010 and for operating pneumatic tools.

Design

Powerful, compact, electronic flushing unit with oil-free compressor. Handy, easily portable, only 32 kg. Measuring and control devices for automatically running the flushing programs and for documenting the results. Safety devices for avoiding contamination of the pipe network by flow-back. Overpressure valve for pressure limiting. 5 μm condensation and particle filters. Large tubular steel frame as a compressed air tank. Two practical handles for easy carrying. Space-saving, folding handle grip for easy movement. Mobile tubular steel frame with two rubber-tyred wheels for easy transport and 2 rubber feet for firm standing. Connecting cable with integrated personal protection switch (PRCD). 2 hooks for winding up the power cable. Captive seals for input and output of the REMS Multi-Push S to avoid contamination during transport and storage. Practical hood for protecting the machine during transport and storage as an accessory.

Compressor

Proven, powerful, oil-free piston compressor with crank drive, with capacitor motor 230 V, 1500 W. Pressure gauge for displaying the air pressure in the compressed air tank. Emergency stop button.

Hoses

Transparent $\text{Ø } 1''$ suction/pressure hose, with fabric inlay, 1.5 m long, with 1" hose screw fittings, with caps, for flushing, disinfection, cleaning, preservation. Captive caps for the inputs and outputs of the hoses to avoid contamination during transport and storage. Connecting hose compressor/water connections, 0.6 m long, with quick coupling DN 7.2 and 1" hose screw fitting, 1" double nipple, for blowing out water remains from REMS Multi-Push S and suction/pressure hoses at the end of work.

Input and control unit

Easy desilting operation by buttons to switch over the air supply during the flushing process. Menu-guided input and menu-guided control for flushing drinking water installations according to EN 806-4:2010 with the possibility for the user to change the factory-set default values for adaptation to the applicable national safety provisions, rules and regulations for the application site. Format selection for date and time and selection of the different units. Input and control unit with 3" display with modern LCD technology, 76 mm screen diagonal, 128 x 64 pixels. Permanent process monitoring during the program sequences. USB port for USB stick or printer. The respective latest version software for the input and control unit is available via USB stick as a download under www.rems.de > Downloads > Software.

Patent EP 2 954 960

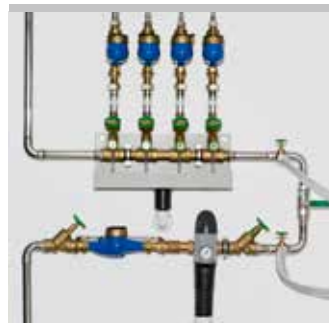

German Quality Product



Info

REMS Multi-Push S

Electronic flushing unit with compressor

Desilting and flushing

Buttons for easy switching of the air supply during the flushing process when desilting radiator and flat heater systems with the following possibilities: (1) without compressed air, (2) intermittent compressed air, (3) constant compressed air.

Flushing according to EN 806-4

Flushing of drinking water installations with water or with a water/air mixture with intermittent compressed air in accordance with EN 806-4:2010 and information leaflet "Flushing, Disinfection and Commissioning of Drinking Water Installations" (August 2014) of the German Central Association for Sanitary, Heating and Air Conditioning (ZVSHK).

Disinfection

REMS V-Jet TW disinfection unit for disinfection of drinking water installations in accordance with EN 806-4:2010 and information leaflet "Flushing, Disinfection and Commissioning of Drinking Water Installations" (August 2014) of the German Central Association for Sanitary, Heating and Air Conditioning (ZVSHK) and other pipe systems, as an accessory. REMS Peroxi Color, consisting of a 1 l bottle of REMS Peroxi dosing solution for disinfection of approx. 100 l line volume and 20 ml bottle of red REMS Color dye for dyeing the dosing solution for filling and wash-out check, pipette for checking the effectiveness of the dosing solution, as an accessory. Feeding of the disinfectant solution without additional dosing pump (Patent EP 2 954 960).

Cleaning and preservation

REMS V-Jet H cleaning and preservation unit for cleaning and preserving radiators and area heating systems, as an accessory. Cleaner, dyed green for filling and wash-out check and corrosion protection, dyed blue for filling check, for approx. 100 l line volume respectively, as an accessory. Feeding of cleaner and corrosion protection without additional dosing pump (Patent EP 2 954 960).

Operation of pneumatic tools

Connection for pneumatic tools up to an air requirement ≤ 230 NI/min, adjustable, for adaptation to the pneumatic tool being used. Pressure gauge for controlling the air pressure supplied by the compressed air tank. Pneumatic hose with quick coupling DN 7.2, as an accessory.

Logging

Results of the flushing programs are saved with date, time and log number in the selected language and can be transferred to USB stick or printer for documentation. Printer as an accessory. Additions to saved data, e.g. customer name, project number, tester, are possible on external devices (e.g. PC, laptop, tablet-PC, Smartphone).



Supply format

REMS Multi-Push S Set. Electronic flushing unit with oil-free compressor. For flushing with water or a water/air mixture, disinfection, cleaning, preservation of pipe systems, e.g. for desilting, cleaning and preservation of radiators and area heating systems, flushing and disinfection of drinking water installations and for operation of pneumatic tools ≤ 230 NI/min. Input and control unit. Piston compressor with crank drive, capacitor motor 230V, 50 Hz, 1,500 W, person circuit breaker (PRCD). Mobile tubular steel frame. Fastenings for water input and output of the REMS Multi-Push S. Two $\varnothing 1$ " suction/pressure hoses, with fabric inlay, 1.5 m long, with 1" hose screw fittings, with caps. Connecting hose compressor/ water connections, 0.6 m long, with quick coupling DN 7.2 and 1" hose screw fitting, 1" double nipple, for blowing out water remains from REMS Multi-Push S and suction/pressure hoses at the end of work. Without disinfection unit, without cleaning and preservation unit. In a carton

Art.-No.
115810

Other voltages on request.



REMS Multi-Push S

Electronic flushing unit with compressor

Description	Art.-No.
Fine filter with fine filter cartridge 90 µm , washable, with large dirt collection vessel	115609
Fine filter cartridge 90 µm , for fine filter with fine filter cartridge 90 µm	043054
Compressed air hose Ø 14 mm , 1.5 m long, with quick couplings DN 7.2 (plug, socket), for connecting pneumatic tools	115621
Ø 1" suction/pressure hose , with fabric inlay, 1.5 m long, with G 1" screw fittings for flushing, disinfection, cleaning, preservation and pressure testing with water.	115633
Double nipple 1" , for connecting 2 suction/pressure hoses and blowing out the suction/pressure hoses	045159
Printer for printing the stored results of the flushing and test programs, 1 roll of paper, USB connecting cable, power supply/charger Ni-Mh 100–240 V, 50–60 Hz, 3 W	115604
Paper roll , pack of 5 for printer	090015
Case with inlays for printer, paper rolls and other accessories	115703
REMS V-Jet TW , disinfection unit for drinking water installations, for feeding dosing solution for disinfection	115602
REMS Peroxi Color , 1 l bottle of REMS Peroxi dosing solution for disinfection of approx. 100 l line volume, 20 ml bottle of red REMS Color dye for dyeing the dosing solution for filling and wash-out check, pipette for checking the effectiveness of the dosing solution.	115605
Test strips H₂O₂ 0–1,000 mg/l , pack of 100, for checking the concentration of the disinfection solution	091072
Test strips H₂O₂ 0–50 mg/l , pack of 100, for checking the complete flushing out of the disinfection solution after disinfection	091073
REMS V-Jet H , cleaning and preservation unit for radiators and area heating systems, for feeding cleaner and corrosion protection.	115612
REMS CleanH 1 l bottle of cleaner for radiators and area heating systems, dyed green for filling and wash-out check, for approx. 100 l line volume.	115607
REMS NoCor 1 l bottle of corrosion protection for preservation of radiators and area heating systems, dyed blue for filling check, for approx. 100 l line volume.	115608
Hood for protecting the machine during transport and storage	115677
XL-Boxx system case for hoses	579600



REMS Multi-Push SL/SLW

Electronic flushing and pressure testing unit with compressor

Powerful, compact, electronic flushing and pressure testing unit with oil-free compressor. For flushing with water or a water/air mixture, disinfection, cleaning, preservation of pipe systems, for pressure testing of pipe systems and vessels with compressed air or water, as a pneumatic pump for controlled filling of all types of vessels with compressed air and for operation of pneumatic tools.

Flushing and desilting

Water pressure pipe network $p \leq 1 \text{ MPa}/10 \text{ bar}/145 \text{ psi}$

Pipe diameter installation $\leq \text{DN } 50, 2''$

Disinfection of drinking water installations

Cleaning and preservation of radiators and area heating systems

Water temperature $5 - 35^\circ\text{C}$

Water flow $\leq 5 \text{ m}^3/\text{h}$

Pressure test

with compressed air $p \leq 0.4 \text{ MPa}/4 \text{ bar}/58 \text{ psi}$

Pressure test with water $p \leq 1.8 \text{ MPa}/18 \text{ bar}/261 \text{ psi}$

Pneumatic pump for controlled filling of all types of vessels with compressed air $p \leq 0.8 \text{ MPa}/8 \text{ bar}/116 \text{ psi}$

Operation of pneumatic tools

Operating pressure $p \leq 0.8 \text{ MPa}/8 \text{ bar}/116 \text{ psi}$

Suction rate $\leq 230 \text{ NI}/\text{min}$

REMS Multi-Push SL/SLW – just one device with more than 10 automatically running flushing and pressure testing programs. Permanent process monitoring. Logging. USB interface.

Universal use

Only **one** device for flushing with water or a water/air mixture, disinfection, cleaning, preservation of pipe systems, for pressure testing of pipe systems and vessels with compressed air or water, e.g. drinking water installations, radiators or area heating systems, for pressure testing of gas installations with compressed air, as a pneumatic pump for controlled filling of all types of vessels with compressed air, e.g. for pumping up expansion vessels or tyres and for operating pneumatic tools. (Patent EP 2 816 231).

Design

Powerful, compact, electronic flushing and pressure testing unit with oil-free compressor. Handy, easily portable, REMS Multi-Push SL only 37 kg, REMS Multi-Push SLW only 39 kg. Measuring and control devices for automatically running the flushing and test programs and for documenting the results. Safety devices for avoiding contamination of the pipe network by flow-back. Overpressure valves for pressure limiting. 5 μm condensation and particle filters. Large tubular steel frame as a compressed air tank. Two practical handles for easy carrying. Space-saving, folding handle grip for easy movement. Mobile tubular steel frame with two rubber-tyred wheels for easy transport and 2 rubber feet for firm standing. Connecting cable with integrated personal protection switch (PRCD). 2 hooks for winding up the power cable. Captive seals for inputs and outputs of the REMS Multi-Push SL/SLW to avoid contamination during transport and storage. Practical hood for protecting the machine during transport and storage as an accessory.

REMS Multi-Push SLW additionally with hydro-pneumatic water pump for generating the necessary water pressure for hydrostatic pressure testing of pipe systems and vessels with water.

Compressor

Proven, powerful, oil-free piston compressor with crank drive, with capacitor motor 230V, 1500W. Pressure gauge for displaying the air pressure in the compressed air tank. Emergency stop button.

Hoses

Transparent $\text{Ø } 1''$ suction/pressure hose, with fabric inlay, 1.5 m long, with 1" hose screw fittings, with caps, for flushing, disinfection, cleaning, preservation and pressure testing with water. High-pressure hose $\text{Ø } \frac{1}{2}''$, with fabric inlay, 1.5 m long, with $\frac{1}{2}''$ hose screw fittings, with caps, for pressure testing with water with REMS Multi-Push SLW. Captive caps for the inputs and outputs of the hoses to avoid contamination during transport and storage. Compressed air hose $\text{Ø } 8 \text{ mm}$, 1.5 m long, with quick coupling DN 5 and $\frac{1}{2}''$ hose screw fitting, for pressure testing with compressed air. Compressed air hose $\text{Ø } 8 \text{ mm}$, 1.5 m long, with quick coupling DN 5 (plug, socket) for gas testing with compressed air. Connecting hose compressor/water connections, 0.6 m long, with quick coupling DN 7.2 and 1" hose screw fitting, 1" double nipple, for blowing out water remains from REMS Multi-Push SL/SLW and suction/pressure hoses at the end of work.

Patent EP 2 816 231
Patent EP 2 954 960

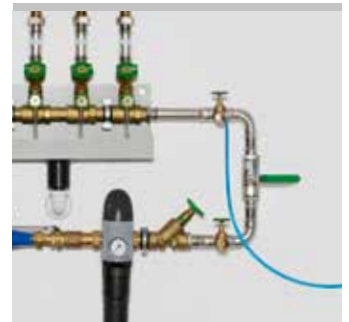
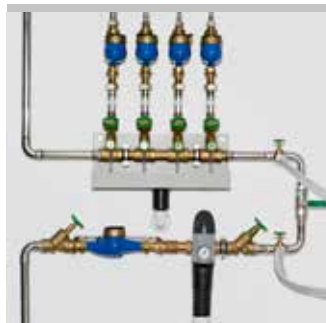

German Quality Product

Input and control unit

More than 10 flushing and test programs in 26 languages. Easy desilting operation by buttons to switch over the air supply during the flushing process. Menu-guided input and menu-guided control for flushing drinking water installations according to EN 806-4:2010 with the possibility for the user to change the factory-set default values for adaptation to the applicable national safety provisions, rules and regulations for the application site. Format selection for date and time and selection of the different units. Input and control unit with 3" display with modern LCD technology, 76 mm screen diagonal, 128 x 64 pixels. Permanent process monitoring during the program sequences. USB port for USB stick or printer. The respective latest version software for the input and control unit is available via USB stick as a download under www.rems.de > Downloads > Software.

Desilting and flushing

Buttons for easy switching of the air supply during the flushing process when desilting radiator and flat heater systems with the following possibilities: (1) without compressed air, (2) intermittent compressed air, (3) constant compressed air.

Flushing according to EN 806-4

Flushing of drinking water installations with water or with a water/air mixture with intermittent compressed air in accordance with EN 806-4:2010 and information leaflet "Flushing, Disinfection and Commissioning of Drinking Water Installations" (August 2014) of the German Central Association for Sanitary, Heating and Air Conditioning (ZVSHK).

Disinfection

REMS V-Jet TW disinfection unit for disinfection of drinking water installations in accordance with EN 806-4:2010 and information leaflet "Flushing, Disinfection and Commissioning of Drinking Water Installations" (August 2014) of the German Central Association for Sanitary, Heating and Air Conditioning (ZVSHK) and other pipe systems, as an accessory. REMS Peroxi Color, consisting of a 1 l bottle of REMS Peroxi dosing solution for disinfection of approx. 100l line volume and 20 ml bottle of red REMS Color dye for dyeing the dosing solution for filling and wash-out check, pipette for checking the effectiveness of the dosing solution (page 123). Feeding of the disinfectant solution without additional dosing pump (Patent EP 2 954 960).

Cleaning and preservation

REMS V-Jet H cleaning and preservation unit for cleaning and preserving radiators and area heating systems, as an accessory. Cleaner, dyed green for filling and wash-out check and corrosion protection, dyed blue for filling check, for approx. 100 l line volume respectively (page 123). Feeding of cleaner and corrosion protection without additional dosing pump (Patent EP 2 954 960 pending).

Pressure testing with compressed air

Leak testing of drinking water installations with compressed air according to information leaflet "Leak Testing of Drinking Water Installations with Compressed Air, Inert Gas or Water" (January 2011) of the German Central Association for Sanitary, Heating and Air Conditioning (ZVSHK), leak testing of gas installations with compressed air according to the technical rule "DVGW-TRGI 2018, Technical Rules for Gas Installations - DVGW Worksheet G 600" of the German Gas and Water Association (DVGW) and leak testing of other pipe systems and vessels with compressed air.

Load testing of drinking water installations with compressed air according to information leaflet "Leak Testing of Drinking Water Installations with Compressed Air, Inert Gas or Water" (January 2011) of the German Central Association for Sanitary, Heating and Air Conditioning (ZVSHK), load testing of gas installations with compressed air according to the technical rule "DVGW-TRGI 2018, Technical Rules for Gas Installations - DVGW Worksheet G 600" of the German Gas and Water Association (DVGW) and load testing of other pipe systems and vessels with compressed air.

Pressure testing with water

REMS Multi-Push SLW with hydro-pneumatic water pump for hydrostatic pressure testing of drinking water installations with water in accordance with EN 806-4:2010, test method A, B or C or test method B, modified in accordance with information leaflet "Leak Testing of Drinking Water Installations with Compressed Air, Inert Gas or Water" (January 2011) of the German Central Association for Sanitary, Heating and Air Conditioning (ZVSHK) and for pressure testing of other pipe systems and vessels.

Pneumatic pump

Pneumatic pump for controlled filling of all types of vessels with compressed air ≤ 0.8 MPa/8 bar/116 psi, with automatic switch-off on reaching the preset air pressure, e.g. for pumping up expansion vessels or tyres.

Operation of pneumatic tools

Connection for pneumatic tools up to an air requirement ≤ 230 NI/min, adjustable, for adaptation to the pneumatic tool being used. Pressure gauge for controlling the air pressure supplied by the compressed air tank. Pneumatic hose with quick coupling DN 7.2, as an accessory.

Logging

Results of the flushing and test programs are saved with date, time and log number in the selected language and can be transferred to USB stick or printer for documentation. Printer as an accessory. Additions to saved data, e.g. customer name, project number, tester, are possible on external devices (e.g. PC, laptop, tablet-PC, Smartphone).



REMS Multi-Push SL/SLW

Electronic flushing and pressure testing unit with compressor

Supply format

REMS Multi-Push SL Set. Electronic flushing and pressure testing unit with oil-free compressor. For flushing with water or a water/air mixture, disinfection, cleaning, preservation of pipe systems, e.g. for desilting, cleaning and preservation of radiators and area heating systems, flushing and disinfection of drinking water installations, for pressure testing of pipe systems and vessels with compressed air, as a pneumatic pump for controlled filling of all types of vessels with compressed air $p \leq 0.8 \text{ MPa}/8 \text{ bar}/116 \text{ psi}$, and for operation of pneumatic tools $\leq 230 \text{ NI}/\text{min}$. Input and control unit. Piston compressor with crank drive, capacitor motor 230V, 50 Hz, 1,500 W, person circuit breaker (PRCD). Mobile tubular steel frame. Fastenings for water inputs and outputs of the REMS Multi-Push. Two $\varnothing 1''$ suction/pressure hoses, with fabric inlay, 1.5 m long, with 1'' hose screw fittings, with caps. One $\varnothing 8 \text{ mm}$ compressed air hose, 1.5 m long, with quick coupling DN 5 and G $\frac{1}{2}''$ hose screw fitting, for pressure testing with compressed air. Connecting hose compressor/water connections, 0.6 m long, with quick coupling DN 7.2 and 1'' hose screw fitting, 1'' double nipple, for blowing out water remains from REMS Multi-Push and suction/pressure hoses at the end of work. Without disinfection unit, without cleaning and preservation unit. In a carton

	Art.-No.
	115610

Other voltages on request.



Info



Supply format

REMS Multi-Push SLW Set. Same as REMS Multi-Push SL Set, Art. No. 115610, additionally with hydro-pneumatic water pump for hydrostatic pressure testing of drinking water installations with water in accordance with EN 806-4:2010, test method A, B or C or test method B and for pressure testing of other pipe systems and vessels. One high-pressure hose $\varnothing \frac{1}{2}''$, 1.5 m long, with $\frac{1}{2}''$ hose screw fittings, with caps. In a carton.

	Art.-No.
	115611

Other voltages on request.



Info



Accessories

Description	Art.-No.
Fine filter with fine filter cartridge 90 μm , washable, with large dirt collection vessel	115609
Fine filter cartridge 90 μm , for fine filter with fine filter cartridge 90 μm	043054
Pressure gauge, $p \leq 6 \text{ MPa}/60 \text{ bar}/870 \text{ psi}$, for pressure and leak testing of pipe systems and vessels up to 6 MPa/60 bar/870 psi.	115140
Fine scaled pressure gauge, $p \leq 1.6 \text{ MPa}/16 \text{ bar}/232 \text{ psi}$, for pressure and leak testing of pipe systems and vessels up to 1.6 MPa/16 bar/232 psi. CL 1.0.	115045
Fine scaled pressure gauge, $p \leq 250 \text{ hPa}/250 \text{ mbar}/3.6 \text{ psi}$, for pressure and leak testing of pipe systems and vessels up to 250 hPa/250 mbar/3.6 psi. CL 1.6.	047069
Compressed air hose $\varnothing 14 \text{ mm}$, 1.5 m long, with quick couplings DN 7.2 (plug, socket), for connecting pneumatic tools	115621
Compressed air hose $\varnothing 8 \text{ mm}$, 7 m long, with quick coupling DN 5 (plug) and G $\frac{1}{2}''$ hose screw fitting, for pressure testing with compressed air.	115667
Compressed air hose $\varnothing 8 \text{ mm}$, 1.5 m long, with quick coupling DN 5 (plug, socket) for gas testing with compressed air.	115747
High-pressure hose $\varnothing \frac{1}{2}''$, 7 m long, with G $\frac{1}{2}''$ hose screw fittings, with caps, for pressure testing of pipe systems and vessels with water with REMS Multi-Push SLW.	115661
$\varnothing 1''$ suction/pressure hose , with fabric inlay, 1.5 m long, with G 1'' screw fittings for flushing, disinfection, cleaning, preservation and pressure testing with water.	115633
Double nipple 1" , for connecting 2 suction/pressure hoses and blowing out the suction/pressure hoses	045159



REMS Multi-Push SL/SLW

Electronic flushing and pressure testing unit with compressor

Description	Art.-No.
Printer for printing the stored results of the flushing and test programs, 1 roll of paper, USB connecting cable, power supply/charger Ni-Mh 100–240 V, 50–60 Hz, 3 W	115604
Paper roll , pack of 5 for printer	090015
Case with inlays for printer, paper rolls and other accessories	115703
REMS V-Jet TW , disinfection unit for drinking water installations, for feeding dosing solution for disinfection	115602
REMS Peroxi Color , 1 l bottle of REMS Peroxi dosing solution for disinfection of approx. 100 l line volume, 20 ml bottle of red REMS Color dye for dyeing the dosing solution for filling and wash-out check, pipette for checking the effectiveness of the dosing solution.	115605
Test strips H₂O₂ 0–1,000 mg/l, pack of 100 , for checking the concentration of the disinfection solution	091072
Test strips H₂O₂ 0–50 mg/l, pack of 100 , for checking the complete flushing out of the disinfection solution after disinfection	091073
REMS V-Jet H , cleaning and preservation unit for radiators and area heating systems, for feeding cleaner and corrosion protection.	115612
REMS CleanH 1 l bottle of cleaner for radiators and area heating systems, dyed green for filling and wash-out check, for approx. 100 l line volume.	115607
REMS NoCor 1 l bottle of corrosion protection for preservation of radiators and area heating systems, dyed blue for filling check, for approx. 100 l line volume.	115608
Hood for protecting the machine during transport and storage	115677
XL-Boxx system case for hoses	579600



REMS CleanM

Machine cleaner

Highly effective machine cleaner for fast, reliable removal of oily and greasy soiling of all kinds. For cleaning and degreasing machines, tools etc. For trade and industry.

REMS CleanM – you can't get cleaner than that. Very high cleaning effect.

Especially for fast, reliable removal of oily and greasy soiling of all kinds. Easily biodegradable according to OECD 302 B. Free from substances classified as harmful to the environment.

Universal cleaner for trade and industry. For cleaning and degreasing machines and tools.

Can also be used for removing lime scale.

REMS CleanM spray bottle without propellant.

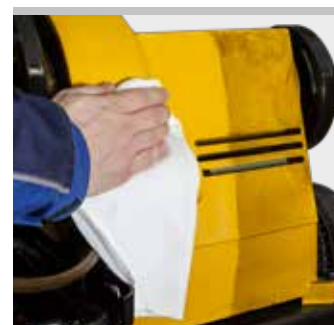

German Quality Product



Info



Supply format

REMS CleanM. Highly effective machine cleaner for fast and reliable removal of oily and greasy soiling. For cleaning and degreasing machines, tools etc.

Packing	Art.-No.
500 ml spray bottle	140119

Powerful electric filling and flushing unit for fast, easy filling, flushing and venting of closed systems. Ideal for solar power systems, ground heat systems and underfloor/wall heating.

Tank volume 30 litres

REMS Solar-Push K 60 with centrifugal pump

Transport capacity at 40 m pumping head 16 l/min

Transport volume ≤ 36 l/min

Transport pressure ≤ 0.55 MPa/5.5 bar/80 psi

Temperature of the transported media (constant load) ≤ 60°C

pH value of the transported media 6.5 – 9.5

REMS Solar-Push I 80 with impeller pump

Transport capacity at 40 m pumping head 18 l/min

Transport volume ≤ 27 l/min

Transport pressure ≤ 0.65 MPa/6.5 bar/94 psi

Temperature of the transported media (constant load) ≤ 80°C

pH value of the transported media 6.5 – 9.5

Media transported: heat transfer liquids, antifreeze, water, aqueous solutions, emulsions

REMS Solar-Push – filling, flushing and venting in one action. Self priming. High transport capacity.

System advantage

Filling, flushing and venting in one action. Ideal for solar power systems, ground heat systems and underfloor/wall heating. Also for filling tanks.

Design

Powerful, electric filling and flushing unit on stable, mobile tubular steel frame for secure standing. 2 large, air-filled tyres for easy transport in rugged building site conditions. Practical hose holder. Low weight, REMS Solar-Push I only 19 kg, REMS Solar-Push K only 20 kg. Sturdy plastic tank to hold 30 litres, made of UV-stabilised PE, with filling level indicator, removable, for easy cleaning, with large opening for easy filling. Practical screw cap for fast opening and closing. Return connection 3/4" with immersion pipe avoids foaming of the transport medium when it enters the plastic tank. Stop tap for easy cleaning and easy changing of the plastic tank when using different transport media. Two practical handles for easy carrying of the plastic tank. High temperature-resistant connecting hose between plastic tank and pump. Fine filter in the suction line with large viewing window for easy recognition of residue air in the circuit as well as emitted contamination, e.g. chips, solder and welding residue.

REMS Solar-Push K 60

Self-suction centrifugal pump, suitable for different transport media, e.g. heat transfer liquids, antifreeze, water, aqueous solutions, emulsions. With proven, powerful condenser motor with quiet running, 940 W, on/off switch. High transport volume 36 l/min for fast filling, efficient flushing and venting of closed systems and for filling tanks. Pressure relief valve for simple pressure relief in the pressure hose at the end of operation, as an accessory. For continuous load ≤ 60°C. 2 pieces flexible, transparent PVC fabric hoses 1/2" T60, for pressure and return lines, each 3 m long, with 3/4" hose screw fittings, temperature-resistant ≤ 60°C.

REMS Solar-Push I 80

Dry self-suction impeller pump with special impeller, suitable for different transport media, e.g. heat transfer liquids, antifreeze, water, aqueous solutions, emulsions. With proven, powerful condenser motor with quiet running, 1000 W, on/off switch. High transport volume 27 l/min for fast filling, efficient flushing and venting of closed systems and for filling tanks. Pressure relief valve for simple pressure relief in the pressure hose at the end of operation. For continuous load ≤ 80°C. 2 flexible EPDM fabric hoses 1/2" T100 (synthetic rubber) for pressure and return lines, each 3 m long, with 3/4" hose screw fittings, high temperature-resistant ≤ 100°C.

Extensive accessories

Shut-off valve for closing the pressure or return line, e.g. during transport. Fine filter with fine filter bag 70 µm, consisting of a screw cap with return line connection for return line with 3/4" union, adapter and fine filter bag 70 µm, or fine filter with fine filter cartridge 90 µm, washable, with large dirt collection vessel, for return line with 3/4" connection for flushing underfloor heating/wall radiators and clearing sludge. Flow direction changeover valve complete with EPDM fabric hose 1/2" T100, for flushing underfloor heating/wall radiators and effective clearance of sludge by pressure surges when flow direction changes. Changeover valve for alternative suction of the transport medium from another tank, e.g. for larger volumes.



German Quality Product



K 60



I 80

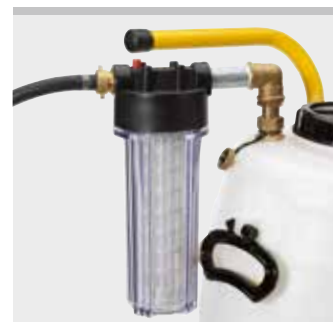

Supply format

REMS Solar-Push K 60. Electric filling and flushing unit for fast, easy filling, flushing and venting of closed systems. Transport volume ≤ 36 l/min, tank volume 30 l. With centrifugal pump, temperature-resistant for continuous load $\leq 60^\circ\text{C}$. Transport pressure ≤ 0.55 MPa/5.5 bar/80 psi. Condenser motor 230 V, 50 Hz, 940 W. 2 pieces flexible, transparent PVC fabric hoses $\frac{1}{2}$ " T60, each 3 m long, temperature-resistant $\leq 60^\circ\text{C}$. On sturdy tubular steel frame with air-filled wheels. In box.

	Art.-No.	
	115312	

Other voltages on request.

Supply format

REMS Solar-Push I 80. Electric filling and flushing unit for fast, easy filling, flushing and venting of closed systems. Transport volume ≤ 27 l/min, tank volume 30 l. With impeller pump, temperature-resistant for continuous load $\leq 80^\circ\text{C}$. Transport pressure ≤ 0.65 MPa/6.5 bar/94 psi. Transport capacity at 40 m transport height 10 l/min. Condenser motor 230 V, 50 Hz, 1000 W. Pressure relief valve. 2 pieces flexible, EPDM fabric hoses $\frac{1}{2}$ " T100, each 3 m long, high temperature-resistant $\leq 100^\circ\text{C}$. On sturdy tubular steel frame with air-filled wheels. In box.

	Art.-No.	
	115311	

Other voltages on request.



Info







Accessories

Description	Art.-No.
PVC fabric hose $\frac{1}{2}$" T60 for pressure or return line, 3 m long, with $\frac{3}{4}$ " hose screw fittings, temperature-resistant $\leq 60^\circ\text{C}$.	115314
EPDM fabric hose $\frac{1}{2}$" T100 for pressure or return line, 3 m long, with $\frac{3}{4}$ " hose screw fittings, high temperature-resistant $\leq 100^\circ\text{C}$	115315
EPDM fabric hose $\frac{1}{2}$" T165 for pressure or return line, 3 m long, with $\frac{3}{4}$ " hose screw fittings, high temperature-resistant $\leq 165^\circ\text{C}$	115319
$\frac{3}{4}$" shut-off valve for closing the pressure or return line, e.g. during transport.	115324
30 l plastic tank made of UV-stabilised PE.	115375
Pressure relief valve for Solar-Push K 60.	115217
Fine filter with fine filter bag 70 μm , consisting of a screw cap with return line connection for return line with $\frac{3}{4}$ " union, adapter, 1 fine filter bag 70 μm , for flushing underfloor heating/wall radiators and clearing sludge	115220
Fine filter bag 70 μm (pack of 10) , fine file filter with fine filter bag 70 μm	115221
Fine filter with fine filter cartridge 90 μm , washable, with large dirt collection vessel, for return line with $\frac{3}{4}$ " union, for flushing underfloor heating/wall radiators and clearing sludge	115323
Fine filter cartridge 90 μm , for fine filter with fine filter cartridge 90 μm	043054
Flow direction changeover valve complete with EPDM fabric hose $\frac{1}{2}$ " T100, for flushing underfloor heating/wall radiators and effective clearance of sludge by pressure surges when flow direction changes	115326
Changeover valve for alternative suction of the transport medium from another tank, e.g. for larger volumes.	115325





Bending

	Single-hand tube bender	128
	Oil-hydraulic hand pipe bender	130
	Cordless electro-hydraulic tube bender	132
	Oil-hydraulic pipe bender	134
	Electric pipe and tube bender	136
	Cordless tube bender	140
	Hand tube bender	142

REMS Swing

Single-hand tube bender

Practical one-hand pipe bender for dimensionally accurate bending of pipes up to 90°. Ideal for on-site work. For trade and industry. For the building site and the workshop.

Soft copper pipes, also thin-walled	Ø 10–22 mm Ø 3/8–7/8" s ≤ 1 mm
Coated soft copper tubes	Ø 10–18 mm Ø 3/8–5/8" s ≤ 1 mm
Soft, coated carbon steel pipes of the pressfitting systems	Ø 12–18 mm s ≤ 1.2 mm
Soft precision steel tubes	Ø 10–18 mm s ≤ 1 mm
Multi-layer composite tubes	Ø 14–32 mm

REMS Swing – bending tubes where they are installed. Ultra light, ultra small, ultra handy. Universally usable for many pipe types. Ultra fast operation by practical multifunction lever for fast in-feed and fast return. Proven, reliable ratchet feed. Ideal also for coated tubes.

Universal use

For sanitary, heating, air conditioning, refrigerating and hydraulic applications. Also for copper thin-walled heating tubes according to EN 1057 and for tubes of pressfitting systems.

Cost advantage

Bender recovered after a few bends through savings on fittings. No costs for fittings, storage, procurement. Savings in soldering joints, pressing joints and working hours. Higher safety thanks to fewer pipe joints.

Design

Compact, job site-proven. Handy and light, drive unit only 0.9 kg. Can be used anywhere, free-hand, in confined areas. Easy, quick working, e.g. Ø 22 mm copper pipe bend in just 9 s. Marked bending formers for exact bending. Overbend, tier bend possible. Easy and rapid changing of bending formers. Back former support S Ø 10–26 mm, rotatable according to the size of the pipe to be bent, with back formers for pipes Ø 10–26 mm, 3/8–7/8". Back former support Ø 32 mm with back formers for pipe Ø 32 mm. Device for reverse bending up to Ø 22 mm, 7/8".

Bending formers and sliding pieces

In high-strength, high-slide, glass-fibre reinforced polyamide. See table on page 129 for bending formers. UP bending formers with smaller bending radii for Uponor Uni Pipe PLUS composite pipes, see below.

Drive

Sturdy drive unit with proven, reliable ratchet feed for the complete work range up to Ø 32 mm. Practical multi-function lever for fast in-feed and fast return saves time and effort.



German Quality Product



Info



Supply format

REMS Swing UP Set. Single-hand tube bender Ø 16–32 mm, up to 90°. for Uponor Uni Pipe PLUS composite pipes Ø 16–32 mm. With UP drive unit, UP bending formers with smaller bending radii, UP back former supports Ø 16–32 mm with back formers, in a sturdy steel box/case.

Description mm	Art.-No.
Set 16 + 20 + 25 + 32	153030

Accessories

Description	Art.-No.
REMS Swing UP drive unit	153300
UP back former support Ø 16–32 mm with back formers for pipes Ø 16–32 mm	153307
UP bending former Ø 16 mm , bending radius 32 mm	153303
UP bending former UP Ø 20 mm , Biegeradius 40 mm	153304
UP bending former UP Ø 25 mm , Biegeradius 62,5 mm	153305
UP bending former UP Ø 32 mm , Biegeradius 80 mm	153306
Steel case with inlay	153265



Supply format

REMS Swing Set. Single-hand tube bender Ø 10–32 mm, Ø 3/8–7/8", up to 90°. Soft copper pipes Ø 10–22 mm, Ø 3/8–7/8", s ≤ 1 mm, soft, coated copper pipes Ø 10–18 mm, Ø 3/8–5/8", s ≤ 1 mm, soft, coated carbon steel pipes of the pressfitting systems Ø 12–18 mm, s ≤ 1.2 mm, soft precision steel pipes Ø 10–18 mm, s ≤ 1 mm, composite tubes Ø 14–32 mm. Up to Ø 26 mm with drive unit, bending formers, back former supports S Ø 10–26 mm with back formers, in a sturdy steel box/case. Up to Ø 32 mm with drive unit, bending formers, 2 back former supports Ø 10–26 mm and Ø 32 mm with back formers, in a sturdy steel case.

Description mm	inch	Art.-No.
Set 12 + 15 + 18 + 22	1/2 + 5/8 + 3/4 + 7/8"	153025
Set 10 + 12 + 15 + 18 + 22	3/8 + 1/2 + 5/8 + 3/4 + 7/8"	153021
Set 12 + 14 + 16 + 18 + 22	1/2 + 3/4 + 7/8"	153020
Set 14 + 16 + 20 + 25/26		153026
Set 14 + 16 + 18 + 20 + 25/26		153022
Set 16 + 20 + 25/26 + 32		153029
Set Allround 22		
10 + 12 + 14 + 15 + 16 + 17 + 18 + 20 + 22	3/8 + 1/2 + 5/8 + 3/4 + 7/8"	153027
Set 16 + 18 + 20 + 25/26 + 32		153023
Set Allround 32		
10 + 12 + 14 + 15 + 16 + 17 + 18 + 20 + 22 + 25/26 + 32	3/8 + 1/2 + 5/8 + 3/4 + 7/8"	153028



Accessories

Description	Art.-No.
REMS Swing drive unit	153100
Back former support S Ø 10–26 mm with back formers for pipes Ø 10–26 mm, 3/8–7/8"	153125
Back former support Ø 32 mm with back formers for pipe Ø 32 mm	153115
Device for reverse bending on laid pipes up to Ø 26 mm, 7/8"	153140
Steel case with inlay	153265
Case with inlay	153270

Bending former for tubes Ø mm/inch	Bending radius ¹⁾ mm	suitable for					Art.-No.
		Cu	Cu-U	St 10305-U	St 10305	V	
10, 3/8"	30	●			●		153155
12, 10 U, 1/2"	36	●	●		●		153160
14, 12 U	50	●		●	●	●	153170
15, 12 U, 5/8"	55	●	●		●		153175
16, 14 U	55	●	●		●	●	153180
17, 15 U	60			●		●	153185
18, 14 U, 15 U, 16 U, 3/4"	72	●	●		●	●	153190
20, 18 U	79	●	●	●		●	153195
22, 18 U, 7/8"	86	●	●				153200
25, 26	88					●	153205
32	128					●	153210

¹⁾ Bending radius mm at the neutral axis of the bend (DVGW GW 392)

- Cu: soft copper tubes, also thin-wall
- St 10305-U: soft, coated carbon steel pipes of the pressfitting systems EN 10305-3
- St 10305: soft precision steel pipes EN 10305-1, EN 10305-2, EN 10305-3
- U: coated
- V: multi-layer composite tubes of pressfitting systems



Effort-saving, oil-hydraulic hand pipe bender for dimensionally accurate bending of pipes up to 90°. Ideal for on-site work. For trade and industry. For the building site and the workshop.

Soft copper pipes, also thin-walled	Ø 10 – 22 mm Ø 3/8 – 7/8" s ≤ 1 mm
Coated soft copper tubes	Ø 10 – 18 mm Ø 3/8 – 5/8" s ≤ 1 mm
Pipes of press fitting systems made of: stainless steel, nickel steel	Ø 15 – 22 mm s ≤ 1.2 mm
Soft, coated carbon steel	Ø 12 – 18 mm s ≤ 1.2 mm
Soft precision steel tubes	Ø 10 – 22 mm s ≤ 1.5 mm
Multi-layer composite tubes	Ø 14 – 32 mm

REMS Hydro-Swing – bending tubes where they are installed. Universally usable for many pipe types. Effortless working due to oil-hydraulic force transmission.

Universal use

For sanitary, heating, air conditioning, refrigerating and hydraulic applications. Also for copper thin-walled heating tubes according to EN 1057 and for tubes of pressfitting systems.

Cost advantage

Bender recovered after a few bends through savings on fittings. No costs for fittings, storage, procurement. Savings in soldering joints, pressing joints and working hours. Higher safety thanks to fewer pipe joints.

Design

Robust, compact drive unit with closed, maintenance-free hydraulic system. Handy and light, only 2.4 kg. Can be used anywhere, even in confined spaces. Easy, quick working, e.g. Ø 22 mm copper pipe bend in just 18 s. Marked bending formers for exact bending. Overbend, tier bend possible. Easy and rapid changing of bending formers. Back former support H-S Ø 10 – 26 mm, rotatable according to the size of the pipe to be bent, with back formers for pipes Ø 10 – 26 mm, 3/8 – 7/8". Back former support Ø 32 mm with back formers for pipes Ø 32 mm.

Bending formers and sliding pieces

Bending formers and back formers made of high strength, high sliding, glass fibre reinforced polyamide or aluminium bending formers. See table on page 131 for bending formers.

Drive

Oil-hydraulic drive unit with hydraulic cylinder made from high-quality, rolled hydraulic tube. Ergonomically designed thrust lever for strength saving pressure build-up with manual hydraulic pump. Reliable hydraulic thrust with overload protection in the foremost piston position and overpressure valves for safe working.

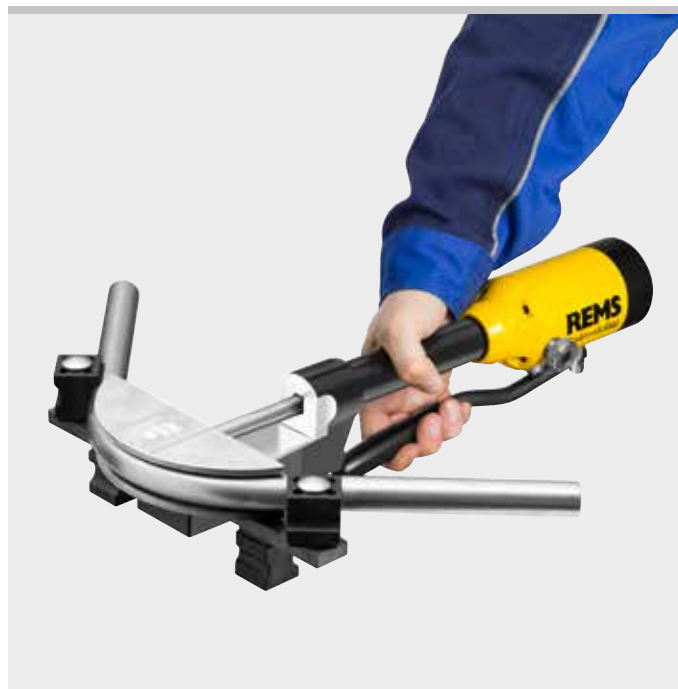

German Quality Product



Info

Supply format

REMS Hydro-Swing Set. Oil-hydraulic hand pipe bender Ø 10–32 mm, Ø 3/8–7/8", up to 90°. Soft copper pipes Ø 10–22 mm, Ø 3/8–7/8", s ≤ 1 mm, soft, coated copper pipes Ø 10–18 mm, Ø 3/8–5/8", s ≤ 1 mm, pipes of the press fitting systems made of soft, coated carbon steel Ø 12–18 mm, s ≤ 1.2 mm, soft precision steel pipes Ø 10–18 mm, s ≤ 1.5 mm, composite tubes Ø 14–32 mm. Up to Ø 26 mm with drive unit, polyamide bending formers, back former support H-S Ø 10–26 mm with back formers, in a sturdy case. Up to Ø 32 mm with drive unit, polyamide bending formers, 2 back former supports Ø 10–26 mm and Ø 32 mm with back formers, in a sturdy case.

Description mm	inch	Art.-No.
Set 12 + 15 + 18 + 22	1/2 + 5/8 + 3/4 + 7/8"	153525
Set 10 + 12 + 15 + 18 + 22	3/8 + 1/2 + 5/8 + 3/4 + 7/8"	153521
Set 12 + 14 + 16 + 18 + 22	1/2 + 3/4 + 7/8"	153520
Set 14 + 16 + 20 + 25/26		153526
Set 14 + 16 + 18 + 20 + 25/26		153522
Set 16 + 20 + 25/26 + 32		153529
Set Allround 22		
10 + 12 + 14 + 15 + 16 + 17 + 18 + 20 + 22	3/8 + 1/2 + 5/8 + 3/4 + 7/8"	153527
Set 16 + 18 + 20 + 25/26 + 32		153523
Set Allround 32		
10 + 12 + 14 + 15 + 16 + 17 + 18 + 20 + 22 + 25/26 + 32	3/8 + 1/2 + 5/8 + 3/4 + 7/8"	153528



Supply format

REMS Hydro-Swing INOX Set. REMS Hydro-Swing with aluminium bending formers, especially also for Geberit Mapress Stainless Steel (EN 10088, 1.4401), Geberit Mapress Stainless Steel (EN 10088, 1.4521, nickel-free), Geberit Mapress Carbon Steel (EN 10305-3, 1.0034 (E195)), Viega Sanpress (EN 10088, 1.4401), Viega Prestabo (EN 10305-3, 1.0308 (E235)).

Description mm	Art.-No.
Set 15 + 18 + 22	153510

Accessories

Description	Art.-No.
REMS Hydro-Swing drive unit	153500
Back former support H-S Ø 10–26 mm with back formers for pipe Ø 10–26 mm, 3/8–7/8"	153501
Back former support Ø 32 mm with back formers for pipe Ø 32 mm	153115
Case with inlay	153570

Bending former for tubes Ø mm/inch	Bending radius ¹⁾ mm	suitable for					Art.-No.
		Cu	Cu-U	St 10217	St 10305	St 10305-U	
10, 3/8"	30	●			●		153155
12, 10 U, 1/2"	36	●	●		●		153160
14, 12 U	50	●			●	●	153170
15 ²⁾	55	●	●	●	●		153531
15, 12 U, 5/8"	55	●	●		●		153175
16, 14 U	55	●	●			●	153180
17, 15 U	60					●	153185
18 ²⁾	72	●	●	●	●	●	153532
18, 14 U, 15 U, 16 U, 3/4"	72	●	●		●	●	153190
20, 18 U	79	●	●			●	153195
22, 18 U, 7/8" ²⁾	86	●	●	●	●		153540
22, 18 U, 7/8"	86	●	●				153200
25, 26	88					●	153205
32	128					●	153210

¹⁾ Bending radius mm at the neutral axis of the bend (DVGW GW 392)

²⁾ Aluminium bending formers

- Cu: soft copper tubes, also thin-wall, EN 1057
- St 10217: stainless, nickel steel pipes of the press fitting systems EN 10217-7, EN 10312, series 2, material 1.4401
- St 10305: soft precision steel pipes EN 10305-1, EN 10305-2, EN 10305-3
- St 10305-U: soft, coated carbon steel pipes of the pressfitting systems EN 10305-3
- U: coated
- V: multi-layer composite tubes of pressfitting systems



REMS Hydro-Swing 22V

Cordless tube bender

Universal, mobile, handy electric tool for dimensionally accurate bending of pipes up to 90°. Ideal for on-site work. For trade and industry. For the building site and the workshop. Li-Ion 22V Technology. For battery and corded operation.

Soft copper pipes, also thin-walled	Ø 10 – 22 mm Ø 3/8 – 7/8" s ≤ 1 mm
Coated soft copper tubes	Ø 10 – 18 mm Ø 3/8 – 5/8" s ≤ 1 mm
Pipes of press fitting systems made of: stainless steel, nickel steel	Ø 15 – 22 mm s ≤ 1.2 mm
Soft, coated carbon steel	Ø 12 – 18 mm s ≤ 1.2 mm
Soft precision steel tubes	Ø 10 – 22 mm s ≤ 1.5 mm
Multi-layer composite tubes	Ø 14 – 32 mm

REMS Hydro-Swing 22V – bending tubes where they are installed. Mobile, handy, light. Universally usable for many pipe types. Li-Ion 21.6V, 2.5Ah battery, for approx. 110 stainless steel pipe bends of the Ø 22 mm press fitting systems with one battery charge*.

Universal use

For sanitary, heating, air conditioning, refrigerating and hydraulic applications. Also for copper thin-walled heating tubes according to EN 1057 and for tubes of pressfitting systems.

Cost advantage

Cordless tube bender recovered after a few bends through savings on fittings. No costs for fittings, storage, procurement. Savings in soldering joints, pressing joints and working hours. Higher safety thanks to fewer pipe joints.

Design

Robust, compact drive unit with closed, maintenance-free hydraulic system. Mobile, handy, light. Drive machine with battery pack weights only 3.0 kg. Can be used anywhere, even in confined spaces. Easy, quick working, e.g. Ø 22 mm stainless steel pipe bend in just 8 s. Marked bending formers for exact bending. Overbend, tier bend possible. Easy and rapid changing of bending formers. Back former support H-S Ø 10 – 26 mm, rotatable according to the size of the pipe to be bent, with back formers for pipes Ø 10 – 26 mm, 3/8 – 7/8". Back former support Ø 32 mm with back formers for pipes Ø 32 mm. LED work light for illuminating the work place.

Bending formers and sliding pieces

Bending formers and back formers made of high strength, high sliding, glass fibre reinforced polyamide or aluminium bending formers. See table on page 133 for bending formers.

Drive

Tons of thrust for crease-free bending within seconds. Thrust force 9 kN. Powerful electro-hydraulic drive with powerful battery motor 21.6 V, 380 W output, robust planetary gear, eccentric reciprocating pump and compact high power hydraulic system. Safety tip switch.

Battery or mains operation

Li-Ion 22V Technology. Highly resistant Li-Ion 21.6V battery with 2.5, 4.4, 5.0 or 9.0 Ah capacity, for long service life. Light and powerful. Li-Ion 21.6V, 2.5 Ah battery for approx. 110 pipe bends, 4.4 Ah for approx. 190 pipe bends, 5.0 Ah for approx. 220 pipe bends, 9.0 Ah for approx. 396 pipe bends of the stainless steel Ø 22 mm press fitting systems with one battery charge*. Graduated charging status check by coloured LEDs. Operating temperature range – 10 to + 60 °C. No memory effect for maximum battery power. Rapid charger 100 – 240V, 90W. Rapid charger 100 – 240V, 290W, for shorter charging times, as accessory. Voltage supply 220 – 240V/21.6V, 15A output, for mains operation instead of Li-Ion battery 21.6 V, as accessory.

Supply format

REMS Hydro-Swing 22V INOX Set. REMS Hydro-Swing 22V with aluminium bending formers, especially also for Geberit Mapress Stainless Steel (EN 10088, 1.4401), Geberit Mapress Stainless Steel (EN 10088, 1.4521, nickel-free), Geberit Mapress Carbon Steel (EN 10305-3, 1.0034 (E195)), Viega Sanpress (EN 10088, 1.4401), Viega Prestabo (EN 10305-3, 1.0308 (E235)).

Description mm	Art.-No.
Set 15 + 18 + 22	153419

Other voltages on request.



German Quality Product



Info



REMS Hydro-Swing 22 V

Cordless tube bender

Supply format

REMS Hydro-Swing 22 V Set. Cordless tube bender Ø 10–32 mm, Ø 3/8–7/8", up to 90°. Soft copper pipes Ø 10–22 mm, Ø 3/8–7/8", s ≤ 1 mm, soft, coated copper pipes Ø 10–18 mm, Ø 3/8–5/8", s ≤ 1 mm, pipes of the press fitting systems made of soft, coated carbon steel Ø 12–18 mm, s ≤ 1.2 mm, soft precision steel pipes Ø 10–18 mm, s ≤ 1.5 mm, composite tubes Ø 14–32 mm. Electro-hydraulic drive with powerful battery motor 21.6 V, 380 W, robust planetary gear, eccentric reciprocating pump and compact high power hydraulic system. Safety tip switch. LED work light. Battery Li-Ion 21.6 V, 2.5 Ah, rapid charger 220–240V or 110 V, 50–60 Hz, 70 W. Up to Ø 26 mm with polyamide bending formers, back former support H-S Ø 10–26 mm with back formers. Up to Ø 32 mm with polyamide bending formers, 2 back former supports Ø 10–26 mm and Ø 32 mm with back formers. In XL-Boxx system case.

Description mm	inch	Art.-No.
Set 12 + 15 + 18 + 22	1/2 + 5/8 + 3/4 + 7/8"	153410
Set 10 + 12 + 15 + 18 + 22	3/8 + 1/2 + 5/8 + 3/4 + 7/8"	153411
Set 12 + 14 + 16 + 18 + 22	1/2 + 3/4 + 7/8"	153412
Set 14 + 16 + 20 + 25/26		153413
Set 14 + 16 + 18 + 20 + 25/26		153414
Set 16 + 20 + 25/26 + 32		153415
Set Allround 22		
10 + 12 + 14 + 15 + 16 + 17 + 18 + 20 + 22	3/8 + 1/2 + 5/8 + 3/4 + 7/8"	153416
Set 16 + 18 + 20 + 25/26 + 32		153417
Set Allround 32		
10 + 12 + 14 + 15 + 16 + 17 + 18 + 20 + 22 + 25/26 + 32	3/8 + 1/2 + 5/8 + 3/4 + 7/8"	153418
Basic-Pack (ohne Biegesegmente und Gleitstücke)		153401

Other voltages on request.



Accessories

Description	Art.-No.
REMS Hydro-Swing 22 V drive unit, without battery	153400
Back former support H-S Ø 10–26 mm with back formers for pipe Ø 10–26 mm, 3/8–7/8"	153501
Back former support Ø 32 mm with back formers for pipe Ø 32 mm	153115
Battery Li-Ion 21.6 V, 2.5 Ah	571571
Battery Li-Ion 21.6 V, 4.4 Ah	571574
Battery Li-Ion 21.6 V, 5.0 Ah	571581
Battery Li-Ion 21.6 V, 9.0 Ah	571583
Rapid charger 100–240 V, 50–60 Hz, 90 W	571585
Rapid charger 100–240 V, 50–60 Hz, 290 W	571587
Voltage supply 220–240 V/21.6 V, 50–60 Hz, 15 A , for mains operation instead of battery Li-Ion 21.6 V	571567
XL-Boxx system case with inserts	153455

Bending former for tubes Ø mm/inch	Bending radius ¹⁾ mm	suitable for					V
		Cu	Cu-U	St 10217	St 10305	St 10305-U	
10, 3/8"	30	●			●		153155
12, 10 U, 1/2"	36	●	●		●		153160
14, 12 U	50	●			●	●	153170
15 ²⁾	55	●	●	●	●		153531
15, 12 U, 5/8"	55	●	●		●		153175
16, 14 U	55	●	●		●	●	153180
17, 15 U	60					●	153185
18 ²⁾	72	●	●	●	●	●	153532
18, 14 U, 15 U, 16 U, 3/4"	72	●	●		●	●	153190
20, 18 U	79	●	●			●	153195
22, 18 U, 7/8" ²⁾	86	●	●	●	●		153540
22, 18 U, 7/8"	86	●	●				153200
25, 26	88					●	153205
32	128					●	153210

¹⁾ Bending radius mm at the neutral axis of the bend (DVGW GW 392)

²⁾ Aluminium bending formers

Cu: soft copper tubes, also thin-wall, EN 1057
 St 10217: stainless, nickel steel pipes of the press fitting systems EN 10217-7, EN 10312, series 2, material 1.4401
 St 10305: soft precision steel pipes EN 10305-1, EN 10305-2, EN 10305-3
 St 10305-U: soft, coated carbon steel pipes of the pressfitting systems EN 10305-3
 U: coated
 V: multi-layer composite tubes of pressfitting systems



* Ambient temperature approx. 20°C.

Robust, oil-hydraulic pipe bender for dimensionally accurate bending of pipes up to 90°. For trade and industry. For the building site and the workshop.

Steel pipes EN 10255	Ø 3/8 – 2"
Multilayer composite tubes	Ø 32 – 75 mm

REMS Python – extremely easy bending up to Ø 2", 75 mm. Ideal for steel pipes EN 10255 and for multilayer composite tubes of the pressfitting systems. Also for producing level bends in different planes.

Universal use

For locksmith work, sanitary and heating installation and machine and plant engineering. Excellently suitable for steel pipes EN 10255 and for multilayer composite tubes of the pressfitting systems.

System advantage

Only **one** bender drive for the whole working range up to Ø 2", Ø 75 mm. Thus simple, inexpensive stocking. No confusion possible.

Cost advantage

Pipe bender is amortised after just a few bends by saving on fittings. No costs for fittings, storage, procurement. Saving of welds, press connections and working time. Increased safety due to fewer pipe connections.

Design

Robust, oil-hydraulic drive unit with closed, maintenance-free hydraulic system. 2 slide roller supports and 2 slide rollers form a closed bending frame for high rigidity and precision when bending. Upper back former support tiltable for easy insertion and removal of the pipe, with marked plug positions for the back formers according to the pipe size to be bent, with angle scale 0 to 90°. Upper slide roller support with laterally adjustable slide roller bearing plate for producing over-bends and level bends according to requirements also in different planes. Can be used anywhere, any time. No setting. Easy, effortless, quick working, e.g. 90° bend Ø 63 mm only 60 s. Tripod as accessory.

Bending formers and back formers

Bending formers St for steel pipes, form and pressure stable, made of highly resistant spheroidal iron. Bending formers V for multilayer composite tubes, form and pressure stable, made of torsion-free shell-cast aluminium. See page 135. Marking on every bending former for dimensionally accurate bending. Angle gauge with angle scale 0 to 180° for dimensionally accurate bending, as an accessory. Optimum matching of bending formers and back formers guarantees material-compatible bending without cracks and creases. High strength back formers for low friction support of the thrust pressure. Fast changing of the bending formers and back formers by simple plug system.

Drive

Oil-hydraulic drive unit with hydraulic cylinder made from high-quality, rolled hydraulic tube. Overload protection of the hydraulic thrust in the foremost piston position and overpressure valves for safe working. Ergonomically designed thrust lever for strength saving pressure build-up with manual hydraulic pump. No danger of crushing due to end limiting of the thrust lever, for high work safety.



German Quality Product



Bridges.



Info



Doglegs on several levels.



Supply format

REMS Python Set. Oil-hydraulic pipe bender for dimensionally accurate bending of pipes up to 90°. Steel pipes EN 10255 Ø ¾ – 2", multilayer composite tubes Ø 32 – 75 mm. Drive unit with back former supports, upper back former support with laterally adjustable back former support bearing plate, 2 back formers, bending formers St or V. In sturdy carrying case.

Description	Art.-No.
Set St ¾ + ½ + ¾ + 1 + 1½"	590020
Set St ½ + ¾ + 1 + 1½ + 2"	590021
Set V 40 + 50 + 63 mm	590022

Accessories

Description	Art.-No.
Drive unit with back former supports and back formers	590000
Slide piece Ø 75 mm (pack of 2)	590111
Tripod	590150
Carrying case with practical handles	590160
Angle gauge for dimensionally accurate bending	590153

Bending former for pipes Ø mm/inch	Bending radius ¹⁾ mm	Bending radius ²⁾ mm	suitable for					Art.-No.
			St 10255	>				
St ¾"	50		●					590051
St ½"	65		●					590052
St ¾"	85		●					590053
St 1"	100		●					590054
St 1¼"	150		●					590055
St 1½"	170		●					590056
St 2"	220		●					590057
V 32 mm	112	128		●				590061
V 40 mm	140	160		●				590058
V 50 mm	175	200		●				590059
V 63 mm	220	252		●				590060
V 75 mm	260	298		▲				590062

St 10255: Steel pipes (threaded pipes) EN 10255
 V: multilayer composite pipes of the pressfitting systems
 ▲ 2 slide pieces Ø 75 mm (Art. No. 590111) required

¹⁾ Bending radius mm on the inside of the bend (EN 10255)

²⁾ Bending radius mm at the neutral axis of the bend (DVGW VP 632)



Universal, compact electric tool for cold bending of pipes and tubes up to 180°. Can be used anywhere, without vice. For trade and industry. For the building site and the workshop.

Hard, half-hard, soft copper tubes also thin-wall	Ø 10 – 35 mm Ø 3/8 – 1 3/8"
--	--------------------------------

Coated soft copper tubes, also thin-wall	Ø 10 – 18 mm
---	--------------

Thick-walled copper pipes K65 for refrigeration and air conditioning technology EN 12735-1	Ø 3/8 – 1 3/8"
--	----------------

Pipes of press fitting systems made of stainless steel	Ø 12 – 28 mm
---	--------------

Carbon steel (coated)	Ø 12 – 28 mm
-----------------------	--------------

Soft precision steel tubes	Ø 10 – 28 mm
----------------------------	--------------

Steel pipes EN 10255	Ø 1/4 – 3/4"
----------------------	--------------

Electric conduit EN 50086	Ø 16 – 32 mm
---------------------------	--------------

Multi-layer composite tubes	Ø 14 – 40 mm
-----------------------------	--------------

REMS Curvo – wrinkle-free bending.
Universal for many pipe types. Instant use without setting. Fast and creep speed operation for precise bending. Rapid change of bending and back formers.

Universal use

For sanitary, heating, air conditioning, refrigerating and hydraulic applications. Specially suited for tubes of pressfitting systems, for hard and half-hard copper tubes and for thin-walled copper heating tubes according to EN 1057.

System advantage

Only one type of bending and back formers for REMS Curvo 22V, REMS Curvo, REMS Curvo 50 and REMS Sinus. Therefore simple, inexpensive stocking. No confusion possible.

Cost advantage

Bender cost recovered after a small number of bends. No costs for fittings, storage, procurement. Savings in soldering joints, pressing joints and working hours. Higher safety thanks to fewer pipe joints.

Design

Compact, handy electric tool with integral absorption of torque during bending. Super light, drive unit only 8 kg. Can be used anywhere, anytime. No setting. Simple, effortless, fast working, e.g. 90° bends, Ø 22 mm in only 6 s. Fast and creep speed operation for precise bending. Overbend, double bend, tier bend, reversed bend possible. Height adjustable machine support as accessory.

Bending formers and back formers

Form and pressure resistant, in high-strength, high-slide, glass-fibre reinforced polyamide. Optimum matching of bending former and back former guarantees material-compatible gliding without cracks and creases. Angle scale 0 to 180° provided on each bending former and mark on the back former ensure precise bending. Rapid change of bending formers and back formers. Bending formers and back formers for different sizes, materials and bending radii (page 143).

Drive

Robust, maintenance-free gear. Final point safety in both directions through safety slipping clutch. Proven, powerful universal motor, 1000 W. Right and left-hand rotation. Stepless electronic safety switch for rapid and creep speed operation.

Bending lubricant

REMS bending spray ensures a permanent lubricating film for reducing energy expenditure and uniform bending. High-pressure-proof, acid-free, CFC-free, so ozone-harmless.



German Quality Product



Supply format

REMS Curvo Set. Electric pipe and tube bender Ø 10–40 mm, Ø ¼–1½", up to 180°. Hard, semi-hard, soft copper pipes, also thin-walled, Ø 10–35 mm, Ø ¾–1½", soft coated copper pipes, also thin-walled, Ø 10–18 mm, thick-walled copper pipes K65 for refrigeration and air conditioning technology EN 12735-1 Ø ¾–1½", pipes of the press fitting systems of stainless steel Ø 12–28 mm, carbon steel, also coated, Ø 12–28 mm, soft precision steel pipes Ø 10–28 mm, steel pipes EN 10255 Ø ¼–¾", electrical installation pipes EN 50086 Ø 16–32 mm, composite tubes Ø 14–40 mm, etc. Drive unit with maintenance-free gear and safety slipping clutch, universal motor 230 V or 110 V, 50–60 Hz, 1000 W, stepless electronic safety switch, right and left-hand rotation, insert bolt. Bending formers and back formers. In sturdy steel case.

Description	Art.-No.
Set 15 + 18 + 22	580026
Set 15 + 18 + 22 + 28 ¹⁾	580027
Set 15 + 18 + 22 + 28 ²⁾	580036
Set 15 + 18 + 22 + 28 ³⁾	580035
Set 12 + 15 + 18 + 22	580020
Set 12 + 15 + 18 + 22 + 28 ¹⁾	580033
Set 12 + 15 + 18 + 22 + 28 ²⁾	580037
Set 15 + 22 + 28 ¹⁾	580022
Set 15 + 22 + 28 ²⁾	580040
Set 17 + 20 + 24	580023
Set 12 + 14 + 16 + 18 + 22	580021
Set 12 + 14 + 16 + 18 + 22 + 28 ¹⁾	580031
Set 12 + 14 + 16 + 18 + 22 + 28 ²⁾	580038
Set 14 + 16 + 18 + 22 + 28 ¹⁾	580028
Set 14 + 16 + 18 + 22 + 28 ²⁾	580039
Set ¾ + ½ + ¾ + ¾ + ¾"	580024
Set 16 + 20 + 26 + 32	580025
Set 16 + 20 + 25 + 32	580034
Set 20 + 25 + 32	580029
Set 32 + 40	580030
Basic-Pack (without bending and back formers)	580010

REMS Curvo Set delivered with the smaller radius bending and back former (except Art.-No. 580029 and 580030), see page 143.

¹⁾ Bending former and back former 28, R102, Art. No. 581070, for hard, semi-hard copper pipes, also thin-walled. See page 143.

²⁾ Bending former and back former 28, ¾" (DN 20), R102, Art. No. 581260, for hard copper pipes Ø 28 mm, Ø 1½", pipes of the press fitting systems of stainless steel/carbon steel Ø 28 mm, steel pipes ¾". See page 143.

³⁾ Bending former and back former 28, ¾" (DN 20), R114, Art. No. 581310, for hard, semi-hard copper pipes Ø 28 mm, pipes of the press fitting systems of stainless steel/carbon steel Ø 28 mm, steel pipes ¾". According to DVGW work sheet GW 392 for hard and semi-hard copper pipes Ø 28 mm minimum bending radius 114 mm necessary. Wall thickness ≥ 0.9 mm. See page 143.

Accessories

Description	Art.-No.
Bending formers and back formers see page 143.	
REMS Curvo drive unit	580000
Insert bolt	582036
REMS bending spray , 400 ml	140120
Steel case with insert	586000
Machine support 3B , height adjustable, on tripod	586100
Machine support WB , height adjustable, for mounting on work bench	586150



Basic-Pack



3B



WB

Universal, compact electric tool for cold bending of pipes and tubes up to 90°. Can be used anywhere, without vice. For trade and industry. For the building site and the workshop.

Steel pipes EN 10255 (DIN 2440)	Ø ¼ – 1¼"
Stainless steel pipes EN ISO 1127, EN 10217-1	Ø ½ – 1¼" s ≤ 2.6 mm
Hard, half-hard, soft copper tubes	Ø 10 – 42 mm
Thin-wall copper tubes	Ø 10 – 35 mm
Thick-walled copper pipes K65 for refrigeration and air conditioning technology EN 12735-1	Ø ¾ – 1⅝"
Pipes of press fitting systems made of stainless steel	Ø 12 – 42 mm
Carbon steel, also coated	Ø 12 – 42 (28) mm
Multi-layer composite tubes	Ø 14 – 50 mm
Further materials, see REMS Curvo	



REMS Curvo 50 – wrinkle free bending of large pipes.

Universal use

For metalwork and in sanitary, heating, air conditioning, refrigeration and hydraulic applications. Specially suited for steel pipe EN 10255, pipe for press-fitting systems, for hard and half hard copper pipe and for thin-walled copper heating pipe according to EN 1057.

System advantage

Bending formers and back formers of REMS Curvo 22V, REMS Curvo and REMS Sinus (page 143) also fit in the REMS Curvo 50 drive machine with adaptor block 10–40, support 10–40. Therefore simple, inexpensive stocking. No confusion possible.

Cost advantage

Bender cost recovered after a small number of bends. No costs for fittings, storage, procurement. Savings in soldering joints, pressing joints and working hours. Higher safety thanks to fewer pipe joints.

Design

Compact, handy electric tool with integral absorption of torque during bending. Can be used anywhere, anytime. No setting. Simple, effortless, fast working, e.g. 90° bends of steel pipe Ø 1¼" in only 37 s. Fast and creep speed operation for precise bending. Overbend, tier bend, reversed bend possible.

Bending formers and back formers

Optimum matching of bending former and back former guarantees material-compatible gliding without cracks and creases. Angle scale provided on each bending former and mark on the back former ensure precise bending. Rapid change of bending formers and back formers. Bending formers and back formers for different sizes, materials and bending radii (page 143). Bending formers and back formers REMS Curvo 50 (Ø 35 R 100, Ø 42 R 140, Ø 50 R 135, Ø 1" R 100, Ø 1¼" R 140): Form and pressure resistant bending formers in ductile iron and back formers in high-strength, high-slide glass-fibre reinforced polyamide.

Drive

Robust, maintenance-free gear. Final point safety in both directions through safety slipping clutch. Proven, powerful universal motor, 1000 W. Right and left-hand rotation. Stepless electronic safety switch for rapid and creep speed operation.

Bending lubricant

REMS bending spray ensures a permanent lubricating film for reducing energy expenditure and uniform bending. High-pressure-proof, acid-free. CFC-free, so ozone-harmless.



German Quality Product



Supply format

REMS Curvo 50 Basic-Pack. Electric pipe and tube bender Ø 10–50 mm, up to 90°. Steel pipes EN 10255 Ø ¼–1¼", stainless steel pipes EN ISO 1127, EN 10217-7, Ø ½–1¼", s ≤ 2.6 mm, hard, semi-hard, soft copper pipes, Ø 10–42 mm, thin-walled copper pipes Ø 10–35 mm, thick-walled copper pipes K65 for refrigeration and air conditioning technology EN 12735-1 Ø ¾–1½", pipes of the press fitting systems of stainless steel Ø 12–42 mm, carbon steel Ø 12–42 mm, coated carbon steel Ø 12–28 mm, composite tubes Ø 14–50 mm, etc. Drive unit with maintenance-free gear and safety slipping clutch, universal motor 230 V or 110 V, 50–60 Hz, 1000 W, stepless electronic safety switch, right and left-hand rotation. Adaptor block 35–50, Support 35–50, insert bolt. In sturdy carrying case.

	Art.-No.
	580110

Other voltages on request.



Accessories

Description	Art.-No.
Bending formers and back formers see page 143.	
REMS Curvo 50 drive unit	580100
Adaptor block 35–50, Support 35–50 , for bending formers and back formers Ø 35 R 100, Ø 42 R 140, Ø 50 R 135, Ø 1" R 100, Ø 1¼" R 140 (see page 143).	582110
Adaptor block 10–40, Support 10–40 , for bending formers and back formers REMS Curvo, REMS Curvo 22V, REMS Sinus (see page 143).	582120
Insert bolt	582036
REMS bending spray , 400 ml	140120
Carrying case with practical handles	590160
Steel case with insert for each bending former and back former R 100 and R 135/R 140, 90°	586012



REMS Curvo 22V

Cordless tube bender

Universal, mobile electric tool for cold bending of pipes up to 180°. Can be used anywhere, without vice. For trade and industry. For the building site and the workshop. Li-Ion 22V Technology. For battery and corded operation.

Hard, half-hard, soft copper tubes also thin-wall	Ø 10–28 mm Ø 3/8–1 1/8"
---	----------------------------

Coated soft copper tubes, also thin-wall	Ø 10–18 mm
--	------------

Thick-walled copper pipes K65 for refrigeration and air conditioning technology EN 12735-1	Ø 3/8–1 1/8"
--	--------------

Pipes of press fitting systems made of stainless steel	Ø 12–28 mm
--	------------

Carbon steel, also coated	Ø 12–28 mm
---------------------------	------------

Soft precision steel tubes	Ø 10–28 mm
----------------------------	------------

Steel pipes EN 10255	Ø 1/4–3/4"
----------------------	------------

Electric conduit EN 50086	Ø 16–25 mm
---------------------------	------------

Multi-layer composite tubes	Ø 14–40 mm
-----------------------------	------------

REMS Curvo 22V – wrinkle-free bending of pipes.

Mobile, handy, light. Universal for many pipe types.

Ready to use immediately without setting. Fast and

creep speed with immediate stop for precise bending.

Quick change of bending and back formers.

Li-Ion 21.6V, 5.0Ah battery, for approx. 90 pipe bends

of the stainless steel Ø 22 mm press fitting systems

with one battery charge*.

Universal use

For sanitary, heating, air conditioning, refrigerating and hydraulic applications. Mains independent. Specially suited for tubes of pressfitting systems, for hard and half-hard copper tubes and for thin-walled copper heating tubes according to EN 1057.

System advantage

Only one type of bending and back formers for REMS Curvo 22V, REMS Curvo, REMS Curvo 50 and REMS Sinus. Therefore simple, inexpensive stocking. No confusion possible.

Cost advantage

Bender cost recovered after a small number of bends. No costs for fittings, storage, procurement. Savings in soldering joints, pressing joints and working hours. Higher safety thanks to fewer pipe joints.

Design

Compact, mobile, handy electric tool with integral absorption of torque during bending. Super light, drive machine with battery pack weights only 8.5 kg. Electronic charging status check with low discharge protection. Practical D-shaped handle with soft grip. Can be used anywhere, anytime. No setting. Simple, effortless, fast working, e.g. 90° bend Ø 22 mm only 6 s. Fast and creep speed with immediate stop for precise bending. Overbend, double bend, tier bend, reversed bend possible. Height adjustable machine support as accessory.

Bending formers and back formers

Form and pressure resistant, in high-strength, high-slide, glass-fibre reinforced polyamide. Optimum matching of bending former and back former guarantees material-compatible gliding without cracks and creases. Angle scale 0 to 180° provided on each bending former and mark on the back former ensure precise bending. Rapid change of bending formers and back formers. Bending formers and back formers for different sizes, materials and bending radii (page 143).

Drive

Robust, maintenance-free gear. Final point safety in both directions through safety slipping clutch. Powerful battery motor 21.6 V, with large power reserve, 500 W output. Right and left-hand rotation. Stepless electronic safety switch for fast and creep speed, with immediate stop. Machine status check with overload protection of the drive unit against too high currents, with overheating protection by motor temperature monitoring (NTC), with electronic battery charging status check with charging level indication by a 2-coloured green/red LED.

Battery or mains operation

Li-Ion 22V Technology. Highly resistant Li-Ion 21.6V battery with 4.4, 5.0 or 9.0 Ah capacity, for long service life. Light and powerful. Li-Ion 21.6V, 4.4 Ah battery, for approx. 79 pipe bends, 5.0Ah battery, for approx. 90 pipe bends, 9.0 Ah for approx. 160 pipe bends of the stainless steel Ø 22 mm press fitting systems with one battery charge*. Graduated charging status check by coloured LEDs. Operating temperature range – 10 to + 60 °C. No memory effect for maximum battery power. Rapid charger 100–240V, 90W. Rapid charger 100–240V, 290W, for shorter charging times, as accessory. Voltage supply 220–240V/21.6V, 40A output, for mains operation instead of Li-Ion battery 21.6 V, as accessory.



German Quality Product



Info

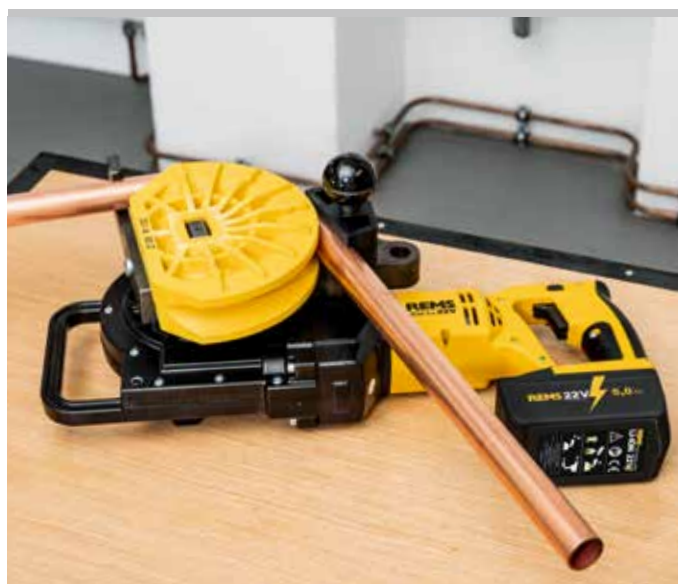

REMS Curvo 22 V

Cordless tube bender

Bending lubricant

REMS bending spray ensures a permanent lubricating film for reducing energy expenditure and uniform bending. High-pressure-proof, acid-free, CFC-free, so ozone-harmless.

Supply format

REMS Curvo 22 V Set. Cordless tube bender Ø 10–40 mm, Ø ¼–1 ½", to 180°. Hard, semi-hard, soft copper pipes, also thin-walled, Ø 10–28 mm, Ø ¾–1 ½", soft coated copper pipes, also thin-walled, Ø 10–18 mm, thick-walled copper pipes K65 for refrigeration and air conditioning technology EN 12735-1 Ø ¾–1 ½", pipes of the press fitting systems of stainless steel Ø 12–28 mm, carbon steel, also coated, Ø 12–28 mm, soft precision steel pipes Ø 10–28 mm, steel pipes EN 10255 Ø ¼–¾", electrical installation pipes EN 50086 Ø 16–25 mm, composite tubes Ø 14–40 mm, etc. Drive machine with D-shaped handle, maintenance-free gear with safely slipping clutch, powerful battery motor 21.6 V, stepless, electronic safety switch with immediate stop, right and left-hand rotation. Machine status check with overload protection, temperature monitoring, battery charging status check. Li-Ion 21.6 V, 5.0 Ah battery, 100–240 V, 50–60 Hz, 90 W rapid charger. Insert bolt. Bending and back formers. In sturdy steel case.

Description	Art.-No.
Set 15 + 18 + 22	580051
Set 15 + 18 + 22 + 28¹⁾	580052
Set 15 + 18 + 22 + 28²⁾	580053
Set 15 + 18 + 22 + 28³⁾	580054
Set 12 + 15 + 18 + 22	580055
Set 12 + 15 + 18 + 22 + 28¹⁾	580056
Set 12 + 15 + 18 + 22 + 28²⁾	580057
Set 15 + 22 + 28¹⁾	580058
Set 15 + 22 + 28²⁾	580059
Set 17 + 20 + 24	580060
Set 12 + 14 + 16 + 18 + 22	580061
Set 12 + 14 + 16 + 18 + 22 + 28¹⁾	580062
Set 12 + 14 + 16 + 18 + 22 + 28²⁾	580063
Set 14 + 16 + 18 + 22 + 28¹⁾	580064
Set 14 + 16 + 18 + 22 + 28²⁾	580065
Set ¾ + ½ + ¾ + ¾ + ¾"	580066
Set 16 + 20 + 26 + 32	580067
Set 16 + 20 + 25 + 32	580068
Set 20 + 25 + 32	580069
Basic-Pack (without bending and back formers)	580014

Other voltages on request.

REMS Curvo 22 V Set delivered with the smaller radius bending and back former (except Art.-No. 580069), see page 143.

¹⁾ Bending former and back former 28, R102, Art. No. 581070, for hard, semi-hard copper pipes, also thin-walled. See page 143.

²⁾ Bending former and back former 28, ¾" (DN 20), R102, Art. No. 581260, for hard copper pipes Ø 28 mm, Ø 1 ½", pipes of the press fitting systems of stainless steel/carbon steel Ø 28 mm. See page 143.

³⁾ Bending former and back former 28, ¾" (DN 20), R114, Art. No. 581310, for hard, semi-hard copper pipes Ø 28 mm, pipes of the press fitting systems of stainless steel/carbon steel Ø 28 mm, steel pipes ¾". According to DVGW work sheet GW 392 for hard and semi-hard copper pipes Ø 28 mm minimum bending radius 114 mm necessary. Wall thickness ≥ 0.9 mm. See page 143.

Accessories

Description	Art.-No.
Bending formers and back formers see page 143.	
REMS Curvo 22 V drive unit, without battery	580004
Battery Li-Ion 21.6 V, 4.4 Ah	571574
Battery Li-Ion 21.6 V, 5.0 Ah	571581
Battery Li-Ion 21.6 V, 9.0 Ah	571583
Rapid charger 100–240 V, 50–60 Hz, 90 W	571585
Rapid charger 100–240 V, 50–60 Hz, 290 W	571587
Voltage supply 220–240 V/21.6 V, 50–60 Hz, 40 A, for mains operation instead of battery Li-Ion 21.6 V	571578
Insert bolt	582036
REMS bending spray, 400 ml	140120
Steel case with inlay	566030
Machine support 3B, height adjustable, on tripod	586100
Machine support WB, height adjustable, for mounting on work bench	586150
REMS Lumen 2800 22 V, cordless LED flood light, see page 111	



Basic-Pack



3B



WB

* Ambient temperature approx. 20°C.

Universal, robust hand tool for cold bending up to 180°. Can be used anywhere. For trade and industry. For the building site and the workshop.

Hard, half-hard, soft copper tubes, also thin-wall	Ø 10 – 22 mm Ø 3/8 – 7/8"
Coated soft copper tubes, also thin-wall	Ø 10 – 18 mm
Pipes of press fitting systems made of stainless steel, carbon steel (coated)	Ø 12 – 18 mm
Carbon steel	Ø 12 – 22 mm
Soft precision steel tubes	Ø 10 – 20 mm
Electric conduit EN 50086	Ø 16 – 20 mm
Multi-layer composite tubes	Ø 14 – 32 mm

REMS Sinus – wrinkle-free bending.
Universal for many tubes. Easy bending through long lever arms. Selectable lever positioning ensures optimum bending position and power transmission. Only one type of bending and back formers for REMS Sinus and REMS Curvo.

Universal use

For sanitary, heating, air conditioning, refrigerating and hydraulic applications. Specially suited for tubes of pressfitting systems, for hard and half-hard copper tubes and for thin-walled copper heating tubes according to EN 1057.

System advantage

Only one type of bending and back formers for REMS Curvo 22V, REMS Curvo, REMS Curvo 50 and REMS Sinus. Therefore simple, inexpensive stocking. No confusion possible.

Cost advantage

Bender cost recovered after a small number of bends. No costs for fittings, storage, procurement. Savings in soldering joints, pressing joints and working hours. Higher safety thanks to fewer pipe joints.

Design

Compact, handy unit of bender drive and bending tools. Can be used anywhere, in parallel vice or free hand as double-hand-bender. Easy bending through long lever arms. Selectable lever positioning ensures optimum bending position and power transmission. Robust design, drive unit in hardened steel for high stress. Simple and rapid changing of bending and back formers. Crossover, swan-neck and U-bends possible.

Bending formers and back formers

For different pipe sizes, materials and bending radii, see page 143.

Bending lubricant

REMS bending spray ensures a permanent lubricating film for reducing energy expenditure and for uniform bending. High-pressure-proof, acid-free. CFC-free, so ozone-harmless.

Supply format

REMS Sinus Set. Hand tube bender Ø 10–32 mm, Ø 3/8–7/8", up to 180°. Hard, half-hard, soft copper tubes, also thin-wall Ø 10–22 mm, Ø 3/8–7/8", coated soft copper tubes, also thin-wall Ø 10–18 mm, pipes of the press fitting systems made of stainless steel, carbon steel (coated) Ø 12–18 mm, soft precision steel tubes Ø 10–22 mm, soft precision steel tubes, Ø 10–20 mm, electric conduit EN 50086, Ø 16–20 mm, multi-layer composite tubes Ø 14–32 mm and others. Drive unit, insert bolt. Bending formers and back formers. REMS bending spray. In sturdy steel case.

Description	Art.-No.
Set 15 + 18 + 22	154001
Set 14 + 16 + 18	154002
Set 12 + 15 + 18 + 22	154003
Set 10 + 12 + 14 + 16 + 18 + 22	154004
Basic-Pack (without bending and back formers and bending spray)	154010

REMS Sinus Set is delivered with bending formers and back formers of the smaller radius, see page 143.

Accessories

Description	Art.-No.
Bending and back formers see page 143.	
Insert bolt	582036
REMS Curvo drive unit	580000
REMS Sinus drive unit	154000
REMS bending spray , 400 ml	140120
Steel case with inlay	154160

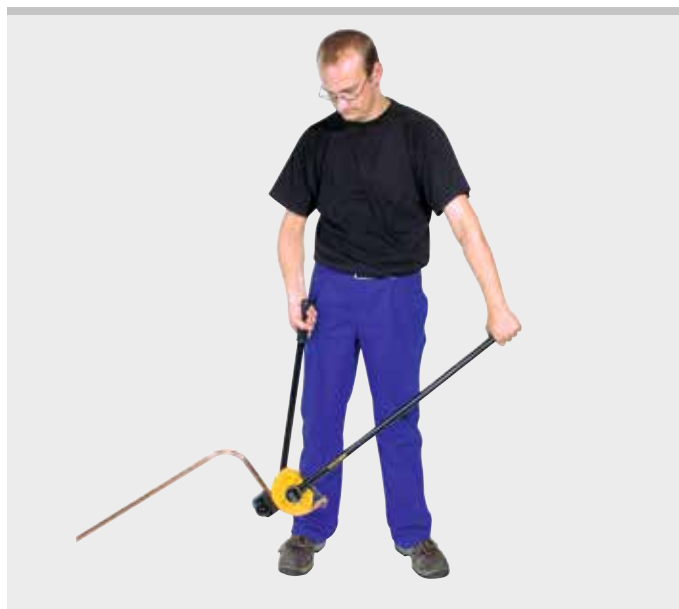
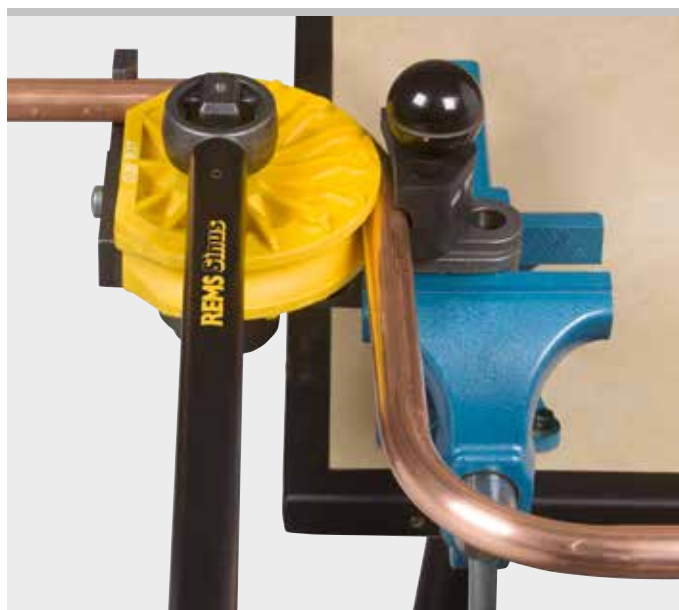

German Quality Product







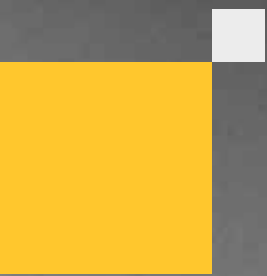









Info





Radial Press Jointing

	Cordless radial press Mini	147
	Pressing tongs Mini	152
	Cropping tongs Mini	181
	Manual radial press	182
	Electric radial press	183
	Electro-hydraulic radial presses	184
	Cordless radial presses	188
	Pressing tongs / pressing rings	198
   	Hold-Harmless and Indemnification Agreement	238
	Cropping tongs	239
	Cable shears	239



5.5 million!

REMS will have produced more than 5.5 million pressing tongs by the end of 2022. This success confirms the leading role of REMS in press-jointing technology.

REMS Mini-Press 14 V ACC

Cordless radial press 22 kN with automatic circuit control

Universal, super handy electric tool with automatic circuit control for producing pipe pressing joints for all common pressfitting systems. For battery and corded operation.

Pipe pressing joints \varnothing 10–40 mm $7 \varnothing \frac{3}{8} - 1 \frac{1}{4}$

Complete range of REMS pressing tongs Mini/pressing rings for all common pressfitting systems, see page 152–180.

REMS Mini-Press 14 V ACC – universal up to \varnothing 40 mm. Super light, super small, super handy. With automatic circuit control. Secure crimping in seconds. Automatic locking of the pressing tongs.

Pressing tongs for all common systems

Complete assortment of REMS pressing tongs Mini/pressing rings for all common pressfitting systems (page 152–180). Can be driven by all REMS radial presses 22 kN. Highly durable pressing tongs/pressing rings made of forged, tenacious, specially hardened special steel. Pressing contours of REMS pressing tongs/pressing rings are system-specific and correspond to the respective pressfitting system. Thus perfect system-conformity, safe press jointing. Adapter tongs required for driving the REMS S (PR-2B) pressing rings, see page 180.

Very compact design and low weight of the REMS Mini pressing tongs due to special arrangement of the pressing tongs connection (**Patent EP 1 952 948**). Recesses in the pressing jaws for safe guidance of the connecting plate for offset-free pressing (**Patent EP 2 347 862**).

Design

Super light, super small, super handy. Drive unit with battery only 2.4 kg. Drive unit with pressing tongs V22 only 33 cm long. Works anywhere, free-hand, overhead, also in particularly tight areas. Optimum weight distribution for single-hand operation. Ergonomically designed housing. LED work light for illuminating the work place. Swivelling pressing tongs seat. Secure seating of pressing tongs/adapter tongs by automatic locking. Electronic charging status check with flat battery protection and charging status indicator with 2-coloured LED.

Pressing operation by touch-control with ACC

For reliable service, operating and functional safety. Automatic retraction after completion of pressing operation (automatic circuit control).

Drive

Enormous thrust and pressing force for fast and perfect press jointing. Thrust force 22 kN. Powerful electro-hydraulic drive with powerful battery motor 14.4 V, 380 W output, robust planetary gear, eccentric reciprocating pump and compact high power hydraulic system. Safety tip switch.

Battery or mains operation

Li-Ion PLUS technology. Highly resistant Li-Ion 14.4 V battery with 2.5 or 5.0 Ah capacity for long service life. Light and powerful. Li-Ion 14.4 V, 2.5 Ah batteries for approx. 275 pressings, 5.0 Ah for approx. 550 pressings Viega Profipress DN 15 with one battery charge*. Operating temperature range –10 to +60 °C. No memory effect for maximum battery power. Rapid charger 220–240 V, 10.8–18 V, 65 W, for short charging times. Voltage supply 220–240 V/14.4 V, 33 A output, for mains operation instead of Li-Ion battery 14.4 V, as accessory.

Supply format

REMS Mini-Press 14 V ACC Basic-Pack. Cordless radial press 22 kN with automatic circuit control for producing pipe pressing joints \varnothing 10–40 mm, $\varnothing \frac{3}{8} - 1 \frac{1}{4}$ ". For operating with REMS pressing tongs Mini/pressing rings. Swivelling pressing tongs seat with automatic locking. Electro-hydraulic drive with powerful battery motor 14.4 V, 380 W, robust planetary gear, eccentric reciprocating pump and compact high power hydraulic system. Safety tip switch. LED work light. Battery Li-Ion 14.4 V, 2.5 Ah, rapid charger 220–240 V, 50–60 Hz, 10.8–18 V, 65 W.

Version	Art.-No.
In sturdy steel case.	578012
In L-Boxx system case.	578013

Other voltages on request.

Accessories

Description	Art.-No.
REMS pressing tongs Mini/pressing rings see page 152–180.	
REMS cropping tongs Mini for threaded rods see page 181.	
REMS Mini-Press 14 V ACC drive unit, without battery	578001
Battery Li-Ion 14.4 V, 2.5 Ah	571545
Battery Li-Ion 14.4 V, 5.0 Ah	571555
Rapid charger 220–240 V, 50–60 Hz, 10.8–18 V, 65 W	571560
Voltage supply 220–240 V/14.4 V, 50–60 Hz, 33 A, for mains operation instead of battery Li-Ion 14.4 V.	571565
Steel case with inlay	578290
L-Boxx system case with inserts	578299



German Quality Product



* Ambient temperature approx. 20°C.

REMS Mini-Press 22 V ACC

Cordless radial press 22 kN with automatic circuit control

Universal, super handy electric tool with automatic circuit control for producing pipe pressing joints for all common pressfitting systems. Li-Ion 22V Technology. For battery and corded operation.

Pipe pressing joints \varnothing 10–40 mm / \varnothing $\frac{3}{8}$ – $1\frac{1}{4}$ "

Complete range of REMS pressing tongs Mini/pressing rings for all common pressfitting systems, see page 152–180.

REMS Mini-Press 22 V ACC – universal up to \varnothing 40 mm. Super light, super small, super handy, ultra fast. Pressing under 4 s. Automatic pressing process. With automatic circuit control. Li-Ion 21.6 V, 2.5 Ah battery for approx. 390 pressings Viega Profipress DN 15 with one battery charge*.

Pressing tongs for all common systems

Complete assortment of REMS pressing tongs Mini/pressing rings for all common pressfitting systems (page 152–180). Can be driven by all REMS radial presses 22 kN. Highly durable pressing tongs/pressing rings made of forged, tenacious, specially hardened special steel. Pressing contours of REMS pressing tongs/pressing rings are system-specific and correspond to the respective pressfitting system. Thus perfect system-conformity, safe press jointing. Adapter tongs required for driving the REMS S (PR-2B) pressing rings, see page 180.

Very compact design and low weight of the REMS Mini pressing tongs due to special arrangement of the pressing tongs connection (**Patent EP 1 952 948**). Recesses in the pressing jaws for safe guidance of the connecting plate for offset-free pressing (**Patent EP 2 347 862**).

Design

Super light, super small, super handy. Drive unit with battery only 2.5 kg. Drive unit with pressing tongs V15 only 31 cm long. Works anywhere, free-hand, overhead, also in particularly tight areas. Optimum weight distribution for single-hand operation. Drive unit with inserted pressing tongs can be put down on the battery ready to pick up. Ergonomically designed housing with soft grip. LED work light for illuminating the work place. Swivelling pressing tongs seat, rotation angle $> 360^\circ$. Secure seating of pressing tongs/adapter tongs by automatic locking.

Pressing operation with ACC

For reliable service, operating and functional safety. Automatic retraction after completion of pressing operation (automatic circuit control). Ultra fast Pressing under 4 s.

Drive

Enormous thrust and pressing force for fast and perfect press jointing. Thrust force 22 kN. Powerful electro-hydraulic drive with powerful battery motor 21.6 V, 380 W output, robust planetary gear, eccentric reciprocating pump and compact high power hydraulic system. Safety tip switch.

Battery or mains operation

Li-Ion 22V Technology. Highly resistant Li-Ion 21.6V battery with 2.5, 4.4, 5.0 or 9.0Ah capacity, for long service life. Light and powerful. Li-Ion 21.6V, 2.5Ah batteries for approx. 390 pressings, 4.4 Ah for approx. 685 pressings, 5.0 Ah for approx. 780 pressings, 9.0 Ah for approx. 1400 pressings Viega Profipress DN 15 with one battery charge*. Graduated charging status check by coloured LEDs. Operating temperature range – 10 to + 60 °C. No memory effect for maximum battery power. Rapid charger 100–240V, 90W. Rapid charger 100–240V, 290W, for shorter charging times, as accessory. Voltage supply 220–240V/21.6V, 15A output, for mains operation instead of Li-Ion battery 21.6 V, as accessory.



German Quality Product



Info



Supply format

REMS Mini-Press 22 V ACC Basic-Pack. Cordless radial press 22 kN with automatic circuit control for producing pipe pressing joints Ø 10–40 mm, Ø ⅜ – 1 ¼". For operating with REMS pressing tongs Mini/pressing rings. Swivelling pressing tongs seat with automatic locking. Electro-hydraulic drive with powerful battery motor 21.6 V, 380 W, robust planetary gear, eccentric reciprocating pump and compact high power hydraulic system. Safety tip switch. LED work light. Battery Li-Ion 21.6 V, 2.5 Ah, rapid charger 220–240 V or 110 V, 50–60 Hz, 70 W.

Version	Art.-No.
In sturdy steel case.	578010
In L-Boxx system case.	578014

Other voltages on request.

Accessories

Description	Art.-No.
REMS pressing tongs Mini/pressing rings see page 152–180.	
REMS cropping tongs Mini for threaded rods see page 181.	
REMS Mini-Press 22 V ACC drive unit, without battery	578002
Battery Li-Ion 21.6 V, 2.5 Ah	571571
Battery Li-Ion 21.6 V, 4.4 Ah	571574
Battery Li-Ion 21.6 V, 5.0 Ah	571581
Battery Li-Ion 21.6 V, 9.0 Ah	571583
Rapid charger 100–240 V, 50–60 Hz, 90 W	571585
Rapid charger 100–240 V, 50–60 Hz, 290 W	571587
Voltage supply 220–240 V/21.6 V, 50–60 Hz, 15 A, for mains operation instead of battery Li-Ion 21.6 V.	571567
Steel case with inlay	578290
L-Boxx system case with inserts	578299
REMS Lumen 2800 22 V, cordless LED flood light, see page 111	



REMS Mini-Press S 22 V ACC

Cordless radial press 22 kN with automatic circuit control

Universal, super handy electric tool with automatic circuit control for producing pipe pressing joints for all common pressfitting systems. Li-Ion 22V Technology. For battery and corded operation.

Pipe pressing joints \varnothing 10–40 mm / \varnothing $\frac{3}{8}$ – $\frac{1}{4}$ "

Complete range of REMS pressing tongs Mini/pressing rings for all common pressfitting systems, see page 152–180.

REMS Mini-Press S 22 V ACC – universal up to \varnothing 40 mm. Super light, super small, super handy, ultra fast. Pressing under 4 s. Automatic pressing process. With automatic circuit control. Li-Ion 21.6V, 2.5 Ah battery for approx. 390 pressings Viega Profipress DN 15 with one battery charge*.

Pressing tongs for all common systems

Complete assortment of REMS pressing tongs Mini/pressing rings for all common pressfitting systems (page 152–180). Can be driven by all REMS radial presses 22 kN. Highly durable pressing tongs/pressing rings made of forged, tenacious, specially hardened special steel. Pressing contours of REMS pressing tongs/pressing rings are system-specific and correspond to the respective pressfitting system. Thus perfect system-conformity, safe press jointing. Adapter tongs required for driving the REMS S (PR-2B) pressing rings, see page 180.

Very compact design and low weight of the REMS Mini pressing tongs due to special arrangement of the pressing tongs connection (**Patent EP 1 952 948**). Recesses in the pressing jaws for safe guidance of the connecting plate for offset-free pressing (**Patent EP 2 347 862**).

Design

Super light, super small, super handy. Drive unit with battery only 2.6 kg. Works anywhere, free-hand, overhead, also in particularly tight areas. Optimum weight distribution for single-hand operation. Drive unit with inserted pressing tongs can be put down on the battery ready to pick up. Ergonomically designed housing with soft grip. LED work light for illuminating the work place. Swivelling pressing tongs seat, rotation angle $>360^\circ$. Secure seating of pressing tongs/adapter tongs by automatic locking.

Pressing operation with ACC

For reliable service, operating and functional safety. Automatic retraction after completion of pressing operation (automatic circuit control). Ultra fast Pressing under 4 s.

Drive

Enormous thrust and pressing force for fast and perfect press jointing. Thrust force 22 kN. Powerful electro-hydraulic drive with powerful battery motor 21.6 V, 380 W output, robust planetary gear, eccentric reciprocating pump and compact high power hydraulic system. Safety tip switch.

Battery or mains operation

Li-Ion 22V Technology. Highly resistant Li-Ion 21.6V battery with 2.5, 4.4, 5.0 or 9.0Ah capacity, for long service life. Light and powerful. Li-Ion 21.6V, 2.5 Ah batteries for approx. 390 pressings, 4.4 Ah for approx. 685 pressings, 5.0 Ah for approx. 780 pressings, 9.0 Ah for approx. 1400 pressings Viega Profipress DN 15 with one battery charge*. Graduated charging status check by coloured LEDs. Operating temperature range – 10 to + 60 °C. No memory effect for maximum battery power. Rapid charger 100–240V, 90W. Rapid charger 100–240V, 290W, for shorter charging times, as accessory. Voltage supply 220–240V/21.6V, 15A output, for mains operation instead of Li-Ion battery 21.6 V, as accessory.



German Quality Product



Info



Supply format

REMS Mini-Press S 22V ACC Basic-Pack. Cordless radial press 22 kN with automatic circuit control for producing pipe pressing joints Ø 10–40 mm, Ø 3/8–1 1/4". For operating with REMS pressing tongs Mini/pressing rings. Swivelling pressing tongs seat with automatic locking. Electro-hydraulic drive with powerful battery motor 21.6 V, 380 W, robust planetary gear, eccentric reciprocating pump and compact high power hydraulic system. Safety tip switch. LED work light. Battery Li-Ion 21.6 V, 2.5 Ah, rapid charger 220–240 V or 110 V, 50–60 Hz, 70 W.

Version	Art.-No.
In sturdy steel case.	578015
In L-Boxx system case.	578016

Other voltages on request.

Accessories

Description	Art.-No.
REMS pressing tongs Mini/pressing rings see page 152 – 180.	
REMS cropping tongs Mini for threaded rods see page 181.	
REMS Mini-Press S 22V ACC drive unit, without battery	578003
Battery Li-Ion 21.6 V, 2.5 Ah	571571
Battery Li-Ion 21.6 V, 4.4 Ah	571574
Battery Li-Ion 21.6 V, 5.0 Ah	571581
Battery Li-Ion 21.6 V, 9.0 Ah	571583
Rapid charger 100–240 V, 50–60 Hz, 90 W	571585
Rapid charger 100–240 V, 50–60 Hz, 290 W	571587
Voltage supply 220–240 V/21.6 V, 50–60 Hz, 15 A, for mains operation instead of battery Li-Ion 21.6 V.	571567
Steel case with inlay	578290
L-Boxx system case with inserts	578299
REMS Lumen 2800 22V, cordless LED flood light, see page 111	



for all common pressfitting systems

**Select REMS pressing tongs Mini/
REMS pressing rings yourself!**

Find the desired press fitting system in the table below and choose the size of pressing tongs/pressing rings that you require. Please note that pressfitting systems for gas installation may only be pressed with the REMS pressing tongs Mini/pressing rings which are highlighted in yellow in the table.

Highly durable pressing tongs/pressing rings made of tenacious, specially hardened special steel. Pressing contours of REMS pressing tongs/pressing rings are system-specific and correspond with the respective pressfitting system. Thus perfect system-conformity, safe press jointing. Pressing jaws of pressing tongs/pressing rings manufactured on CNC production centres ensure high-precision machining of pressing contour. Low production tolerances as a result.

Can be driven by all REMS radial presses 22 kN. Adapter tongs (page 180) required for driving REMS (PR) pressing rings.

Read and observe the instructions for use and the installation instructions of the system provider/manufacturer.

REMS pressing tongs Mini (PZ-2B)

REMS Mini pressing tongs (PZ-2B) with 2 swivellable monoblock pressing jaws. Very compact design and low weight of the REMS Mini pressing tongs due to special arrangement of the pressing tongs connection (**Patent EP 1 952 948**). Recesses in the pressing jaws for safe guidance of the connecting plate for offset-free pressing (**Patent EP 2 347 862**).

REMS Mini ACz, Fz, HEz, RFz, RFlz pressing tongs with teeth prevent formation of burr on the pressfitting (**Patent EP 2 027 971**).

REMS pressing ring S (PR-2B)

REMS pressing ring S (PR-2B), continuously swivellable, with 2 pressing jaws, for secure engagement of the pressing jaws in places of difficult access. Adapter tongs required for driving the REMS S (PR-2B) pressing rings, see page 180.

Traceability according to EN 1775:2007

REMS pressing tongs Mini with pressing contour F, M, V, SA, B, RN and UP have worked a specific marking into the pressing contour which leaves a lasting impression on the pressed fitting after the pressing process. This enables the user to check again whether the most suitable pressing tongs have been used to make the pressfit connection even after the pressing process.

With this traceability REMS fulfils the recommendations of the European standard EN 1775:2007 for the installation of pressfitting systems for gas.



Patent EP 1 952 948
Patent EP 2 347 862

German Quality Product



REMS Mini pressing tongs (PZ-2B)



REMS pressing ring S (PR-2B), continuously swivellable

Confirmation of suitability

See page 237.

Hold-Harmless and Indemnification Agreement

See page 238.



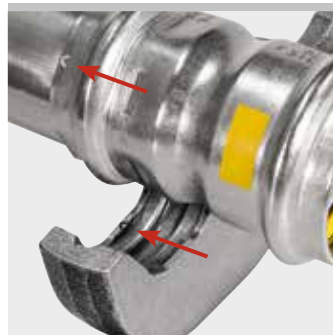
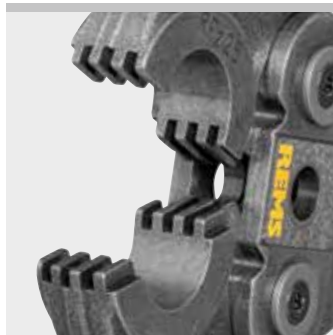

Pressing tongs with teeth prevent formation of burr on the pressfitting. Patent EP 2 027 971

Example REMS pressing tongs Mini V: "V" imprint on pressed fitting for traceability according to EN 1775:2007

System	Pressing tongs / pressing rings	Driven by adapter tongs	Art.-No.	
A				
AC-FIX PRESS (Global Piping Systems)	H 12		578396	
	H 16		578400	
	H 20		578406	
	H 25		578408	
	H 32		578412	
	RFz 12		578490	
	RFz 16		578492	
	RFz 20		578494	
	RFz 25		578496	
	RFz 32		578498	
	U 16		578374	
	U 20		578378	
	U 25		578380	
	U 32		578382	
	VX 16		578552	
	VX 20		578554	
	AC-FIX PRESS DUO (Global Piping Systems)	RFz 16		578492
		RFz 20		578494
		RFz 25		578496
		RFz 32		578498
TH 16			578352	
TH 20			578358	
TH 25			578360	
TH 26			578362	
TH 32			578364	
TH 16 S (PR-2B)		Mini Z8	574782	
TH 20 S (PR-2B)		Mini Z8	574788	
TH 26 S (PR-2B)		Mini Z8	574794	
TH 32 S (PR-2B)		Mini Z8	574798	
U 16			578374	
U 20			578378	
U 25			578380	
U 32		578382		
AC-FIX PRESS-MULTI (Global Piping Systems)	H 16		578400	
	H 18		578404	
	H 20		578406	
	H 25		578408	
	H 32		578412	
	RFz 16		578492	
	RFz 20		578494	
	RFz 25		578496	
	RFz 32		578498	
	U 16		578374	
	U 18		578376	
	U 20		578378	
U 25		578380		
U 32		578382		
ACOME ACOPEX ALU	H 16		578400	
	H 20		578406	
	H 26		578410	
	H 32		578412	
	TH 16		578352	
	TH 20		578358	
	TH 26		578362	
	TH 32		578364	
U 16		578374		
U 20		578378		
U 32		578382		
ACOME MT	ACz 12		578608	
	ACz 16		578610	
	ACz 20		578612	
	ACz 25		578614	
AHLSELL A-press elförzinkad M	M 12		578310	
	M 15		578312	
	M 18		578314	
	M 22		578316	
	M 28		578318	
	M 35		578390	
	M 12 S (PR-2B)	Mini Z8	574736	
	M 15 S (PR-2B)	Mini Z8	574738	
	M 18 S (PR-2B)	Mini Z8	574740	
	M 22 S (PR-2B)	Mini Z8	574742	
M 28 S (PR-2B)	Mini Z8	574744		
M 35 S (PR-2B)	Mini Z8	574746		
AHLSELL A-press elförzinkad V	V 12		578324	
	V 15		578328	
	V 18		578332	
	V 22		578334	
	V 28		578336	
	V 35		578604	
	V 12 S (PR-2B)	Mini Z8	574748	
	V 15 S (PR-2B)	Mini Z8	574752	
	V 18 S (PR-2B)	Mini Z8	574756	
	V 22 S (PR-2B)	Mini Z8	574758	
	V 28 S (PR-2B)	Mini Z8	574760	
	V 35 S (PR-2B)	Mini Z8	574762	
	AHLSELL A-press koppar M	M 12		578310
		M 15		578312
M 18			578314	
M 22			578316	
M 28			578318	
M 35			578390	
M 12 S (PR-2B)		Mini Z8	574736	
M 15 S (PR-2B)		Mini Z8	574738	
M 18 S (PR-2B)		Mini Z8	574740	
M 22 S (PR-2B)		Mini Z8	574742	
M 28 S (PR-2B)		Mini Z8	574744	
M 35 S (PR-2B)		Mini Z8	574746	

System	Pressing tongs / pressing rings	Driven by adapter tongs	Art.-No.
AHLSELL A-press koppar V	V 12		578324
	V 15		578328
	V 18		578332
	V 22		578334
	V 28		578336
	V 35		578604
	V 12 S (PR-2B)	Mini Z8	574748
	V 15 S (PR-2B)	Mini Z8	574752
	V 18 S (PR-2B)	Mini Z8	574756
	V 22 S (PR-2B)	Mini Z8	574758
	V 28 S (PR-2B)	Mini Z8	574760
	V 35 S (PR-2B)	Mini Z8	574762
AHLSELL A-press rostfritt	M 15		578312
	M 18		578314
	M 22		578316
	M 28		578318
	M 35		578390
	M 15 S (PR-2B)	Mini Z8	574738
	M 18 S (PR-2B)	Mini Z8	574740
	M 22 S (PR-2B)	Mini Z8	574742
	M 28 S (PR-2B)	Mini Z8	574744
	M 35 S (PR-2B)	Mini Z8	574746
AIRBEL PRESSCLIM	M 15		578312
	M 18		578314
	M 22		578316
	M 28		578318
	M 35		578390
	M 15 S (PR-2B)	Mini Z8	574738
	M 18 S (PR-2B)	Mini Z8	574740
	M 22 S (PR-2B)	Mini Z8	574742
	M 28 S (PR-2B)	Mini Z8	574744
	M 35 S (PR-2B)	Mini Z8	574746
AIRBEL SERTINOX	M 15		578312
	M 18		578314
	M 22		578316
	M 28		578318
	M 35		578390
	M 15 S (PR-2B)	Mini Z8	574738
	M 18 S (PR-2B)	Mini Z8	574740
	M 22 S (PR-2B)	Mini Z8	574742
	M 28 S (PR-2B)	Mini Z8	574744
	M 35 S (PR-2B)	Mini Z8	574746
ALB Sistema Multicapa	TH 16		578352
	TH 18		578356
	TH 20		578358
	TH 26		578362
	TH 32		578364
	TH 40		578624
	TH 16 S (PR-2B)	Mini Z8	574782
	TH 20 S (PR-2B)	Mini Z8	574788
	TH 26 S (PR-2B)	Mini Z8	574794
	TH 32 S (PR-2B)	Mini Z8	574798
	H 16		578400
	H 18		578404
	H 20		578406
	H 26		578410
H 32		578412	
U 16		578374	
U 18		578376	
U 20		578378	
C 26		578392	
U 32		578382	
U 40		578386	
ALB Sistema Multicapa Gas	TH 16		578352
	TH 20		578358
	TH 26		578362
	TH 32		578364
	TH 16 S (PR-2B)	Mini Z8	574782
	TH 20 S (PR-2B)	Mini Z8	574788
	TH 26 S (PR-2B)	Mini Z8	574794
	TH 32 S (PR-2B)	Mini Z8	574798
	H 16		578400
	H 20		578406
H 26		578410	
H 32		578412	
U 16		578374	
U 20		578378	
C 26		578392	
U 32		578382	
ALTECH Altech	RFz 12		578490
	RFz 16		578492
	RFz 20		578494
	RFz 25		578496
APE MULTYGAS Serie AP Gas	TH 16		578352
	TH 20		578358
	TH 26		578362
	TH 32		578364
	TH 16 S (PR-2B)	Mini Z8	574782
	TH 20 S (PR-2B)	Mini Z8	574788
	TH 26 S (PR-2B)	Mini Z8	574794
	TH 32 S (PR-2B)	Mini Z8	574798
APE Serie AP	B 16		578468
	B 20		578472
	B 26		578474
	B 32		578476
	H 16		578400
	H 20		578406
	H 26		578410
	H 32		578412
	TH 16		578352
	TH 18		578356
	TH 20		578358
	TH 26		578362
	TH 32		578364
	TH 16 S (PR-2B)	Mini Z8	574782
	TH 20 S (PR-2B)	Mini Z8	574788
	TH 26 S (PR-2B)	Mini Z8	574794
TH 32 S (PR-2B)	Mini Z8	574798	
U 16		578374	
U 20		578378	

REMS pressing tongs Mini REMS pressing rings

Accessories for REMS radial presses 22 kN

System	Pressing tongs/ pressing rings	Driven by adapter tongs	Art.-No.	
APE Serie APL	H 16		578400	
	H 18		578404	
	H 20		578406	
	H 26		578410	
	H 32		578412	
	TH 16		578352	
	TH 18		578356	
	TH 20		578358	
	TH 26		578362	
	TH 32		578364	
	TH 40		578624	
	TH 16 S (PR-2B)	Mini Z8	574782	
	TH 20 S (PR-2B)	Mini Z8	574788	
	TH 26 S (PR-2B)	Mini Z8	574794	
	TH 32 S (PR-2B)	Mini Z8	574798	
	U 16		578374	
	U 18		578376	
	U 20		578378	
	AQUATECHNIK Press-fitting metal	H 16		578400
		H 20		578406
H 26			578410	
H 32			578412	
TH 16			578352	
TH 20			578358	
TH 26			578362	
TH 32			578364	
TH 16 S (PR-2B)		Mini Z8	574782	
TH 20 S (PR-2B)		Mini Z8	574788	
TH 26 S (PR-2B)		Mini Z8	574794	
TH 32 S (PR-2B)		Mini Z8	574798	
U 16			578374	
U 20			578378	
C 26			578392	
U 32			578382	
AQUATECHNIK Universal	B 16		578468	
	B 20		578472	
	B 26		578474	
	B 32		578476	
	F 16		578456	
	F 20		578460	
	F 26		578462	
	F 32		578464	
	F 16 S (PR-2B)	Mini Z8	574728	
	F 20 S (PR-2B)	Mini Z8	574730	
	F 26 S (PR-2B)	Mini Z8	574732	
	F 32 S (PR-2B)	Mini Z8	574734	
	H 16		578400	
	H 20		578406	
	H 26		578410	
	H 32		578412	
	TH 16		578352	
	TH 20		578358	
	TH 26		578362	
	TH 32		578364	
TH 16 S (PR-2B)	Mini Z8	574782		
TH 20 S (PR-2B)	Mini Z8	574788		
TH 26 S (PR-2B)	Mini Z8	574794		
TH 32 S (PR-2B)	Mini Z8	574798		
U 16		578374		
U 20		578378		
C 26		578392		
U 32		578382		
ARKA DUROsystem	H 16		578400	
	H 20		578406	
	H 25		578408	
	H 26		578410	
	H 32		578412	
	TH 16		578352	
	TH 20		578358	
	TH 25		578360	
	TH 26		578362	
	TH 32		578364	
	TH 16 S (PR-2B)	Mini Z8	574782	
	TH 20 S (PR-2B)	Mini Z8	574788	
	TH 26 S (PR-2B)	Mini Z8	574794	
	TH 32 S (PR-2B)	Mini Z8	574798	
	U 16		578374	
	U 20		578378	
Aschl NIR	M 15		578312	
	M 18		578314	
	M 22		578316	
	M 28		578318	
	M 35		578390	
	M 15 S (PR-2B)	Mini Z8	574738	
	M 18 S (PR-2B)	Mini Z8	574740	
	M 22 S (PR-2B)	Mini Z8	574742	
	M 28 S (PR-2B)	Mini Z8	574744	
	M 35 S (PR-2B)	Mini Z8	574746	

System	Pressing tongs/ pressing rings	Driven by adapter tongs	Art.-No.	
ASSOTHERM IPC-RAC Carbon Steel	M 15		578312	
	M 18		578314	
	M 22		578316	
	M 28		578318	
	M 35		578390	
	M 15 S (PR-2B)	Mini Z8	574738	
	M 18 S (PR-2B)	Mini Z8	574740	
	M 22 S (PR-2B)	Mini Z8	574742	
	M 28 S (PR-2B)	Mini Z8	574744	
	M 35 S (PR-2B)	Mini Z8	574746	
ASSOTHERM IPI-RAX Inox	M 15		578312	
	M 18		578314	
	M 22		578316	
	M 28		578318	
	M 35		578390	
	M 15 S (PR-2B)	Mini Z8	574738	
ASSOTHERM IPI-RAX Inox Gas	M 15		578312	
	M 18		578314	
	M 22		578316	
	M 28		578318	
	M 35		578390	
	M 15 S (PR-2B)	Mini Z8	574738	
	M 18 S (PR-2B)	Mini Z8	574740	
	M 22 S (PR-2B)	Mini Z8	574742	
	M 28 S (PR-2B)	Mini Z8	574744	
	M 35 S (PR-2B)	Mini Z8	574746	
ASSOTHERM IPM-Multistrato	H 16		578400	
	H 20		578406	
	H 26		578410	
	H 32		578412	
	TH 16		578352	
	TH 20		578358	
	TH 26		578362	
	TH 32		578364	
	THL 32		578368	
	TH 40		578624	
	TH 16 S (PR-2B)	Mini Z8	574782	
	TH 20 S (PR-2B)	Mini Z8	574788	
TH 26 S (PR-2B)	Mini Z8	574794		
TH 32 S (PR-2B)	Mini Z8	574798		
U 16		578374		
U 20		578378		
C 26		578392		
U 32		578382		
ASSOTHERM IPR-RRR Copper	M 15		578312	
	M 18		578314	
	M 22		578316	
	M 28		578318	
	M 35		578390	
	M 15 S (PR-2B)	Mini Z8	574738	
	M 18 S (PR-2B)	Mini Z8	574740	
	M 22 S (PR-2B)	Mini Z8	574742	
	M 28 S (PR-2B)	Mini Z8	574744	
	M 35 S (PR-2B)	Mini Z8	574746	
ASSOTHERM IPR-RRR Copper Gas	M 15		578312	
	M 18		578314	
	M 22		578316	
	M 28		578318	
	M 35		578390	
	M 15 S (PR-2B)	Mini Z8	574738	
ASTM F 1807 (Fittings with Copper Crimp Ring for PEX tubing)	US 3/8"		578534	
	US 1/2"		578536	
	US 3/4"		578538	
	US 1"		578540	
	ATUSA ITALIA SYCPRESS CARBON STEEL PRESS FITTINGS	M 15		578312
		M 18		578314
M 22			578316	
M 28			578318	
M 35			578390	
M 15 S (PR-2B)		Mini Z8	574738	
M 18 S (PR-2B)		Mini Z8	574740	
M 22 S (PR-2B)		Mini Z8	574742	
M 28 S (PR-2B)		Mini Z8	574744	
M 35 S (PR-2B)		Mini Z8	574746	
ATUSA ITALIA SYCPRESS STAINLESS STEEL PRESS FITTINGS	M 15		578312	
	M 18		578314	
	M 22		578316	
	M 28		578318	
	M 35		578390	
	M 15 S (PR-2B)	Mini Z8	574738	
	M 18 S (PR-2B)	Mini Z8	574740	
	M 22 S (PR-2B)	Mini Z8	574742	

Pressfitting systems for gas installations must only be pressed with REMS pressing tongs Mini/pressing rings which are highlighted in yellow.

Observe the national regulations. Read and observe the instructions for use and the installation instructions of the system provider/manufacturer.

- 1) Only pressing tongs from designation "108" (1st quarter of 2008), "208" (2nd quarter of 2008) etc. can be used. The designation is stamped on every pressing jaw.
- 2) For taking suitable pressing inserts.
- 3) Only pressing tongs from designation "117" (1st quarter of 2017), "217" (2nd quarter of 2017) etc. can be used. The designation is stamped on every pressing jaw.
- 4) For pipes of the EN technical standard. Observe the instructions for use of the system provider/manufacturer.
- 5) For pipes of the ASTM technical standard. Observe the instructions for use of the system provider/manufacturer.

The suitability of REMS pressing tools for pressfitting systems: Date 12.10.2022. For the updated situation regarding suitability status check our website:

www.rems.de > Downloads > Product catalogues, brochures > REMS Catalogue.

See page 180 for adapter tongs. Pressing tongs for additional pressfitting systems on request.

System	Pressing tongs / pressing rings	Driven by adapter tongs	Art.-No.
AUSTEC PEX-B, PEX-AL-PEX (AUS)	TH 16		578352
	TH 20		578358
	TH 25		578360
	TH 32		578364
	U 16		578374
	U 20		578378
	U 25		578380
AUSTEC PEX-AL-PEX GAS (AUS)	TH 16		578352
	TH 20		578358
	TH 25		578360
	TH 32		578364
	U 16		578374
	U 20		578378
	U 25		578380
AYOR FIXOCONNECT Press	H 12		578396
	H 16		578400
	H 20		578406
	H 25		578408
	Rfz 12		578490
	Rfz 16		578492
	Rfz 20		578494
	Rfz 25		578496
	U 16		578374
	U 20		578378
	U 25		578380
AYOR FIXOMULTIX	H 16		578400
	H 20		578406
	H 26		578410
	H 32		578412
	TH 16		578352
	TH 20		578358
	TH 26		578362
	TH 32		578364
	TH 16 S (PR-2B)	Mini Z8	574782
	TH 20 S (PR-2B)	Mini Z8	574788
	TH 26 S (PR-2B)	Mini Z8	574794
	TH 32 S (PR-2B)	Mini Z8	574798
	U 16		578374
	U 20		578378
U 32		578382	
U 40		578386	
AYOR SOMATHERM FOR YOU -1	H 16		578400
	H 20		578406
	H 26		578410
	TH 16		578352
	TH 20		578358
	TH 26		578362
	TH 16 S (PR-2B)	Mini Z8	574782
	TH 20 S (PR-2B)	Mini Z8	574788
	TH 26 S (PR-2B)	Mini Z8	574794
	U 16		578374
U 20		578378	
AYOR SOMATHERM FOR YOU -2	H 12		578396
	H 16		578400
	H 20		578406
	H 25		578408
	Rfz 12		578490
	Rfz 16		578492
	Rfz 20		578494
	Rfz 25		578496
	U 16		578374
	U 20		578378
U 25		578380	
B			
Bampi BALPEX serie LP	TH 16		578352
	TH 18		578356
	TH 20		578358
	TH 26		578362
	TH 32		578364
	TH 40		578624
	TH 16 S (PR-2B)	Mini Z8	574782
	TH 20 S (PR-2B)	Mini Z8	574788
	TH 26 S (PR-2B)	Mini Z8	574794
	TH 32 S (PR-2B)	Mini Z8	574798
	U 16		578374
	U 18		578376
	U 20		578378
	C 26		578392
U 32		578382	
Bampi BALPEX serie MP	TH 16		578352
	TH 18		578356
	TH 20		578358
	TH 26		578362
	TH 32		578364
	TH 40		578624
	TH 16 S (PR-2B)	Mini Z8	574782
	TH 20 S (PR-2B)	Mini Z8	574788
	TH 26 S (PR-2B)	Mini Z8	574794
	TH 32 S (PR-2B)	Mini Z8	574798
Bampi BALPEX Gas	TH 16		578352
	TH 20		578358
	TH 26		578362
	TH 16 S (PR-2B)	Mini Z8	574782
	TH 20 S (PR-2B)	Mini Z8	574788
	TH 26 S (PR-2B)	Mini Z8	574794
	TH 32 S (PR-2B)	Mini Z8	574798

System	Pressing tongs / pressing rings	Driven by adapter tongs	Art.-No.
BARBI EASYPRESS (Industrial Blansol)	H 12		578396
	H 16		578400
	H 20		578406
	H 25		578408
	H 32		578412
	Rfz 12		578490
	Rfz 16		578492
	Rfz 20		578494
	Rfz 25		578496
	Rfz 32		578498
	U 16		578374
	U 20		578378
	U 25		578380
	U 32		578382
BARBI MULTIPLEX (Industrial Blansol)	H 14		578398
	H 16		578400
	H 18		578404
	H 20		578406
	H 25		578408
	H 26		578410
	H 32		578412
	Rfz 16		578492
	Rfz 18		578638
	Rfz 20		578494
	Rfz 25		578496
	Rfz 32		578498
	TH 16		578352
	TH 20		578358
TH 26		578362	
TH 32		578364	
TH 16 S (PR-2B)	Mini Z8	574782	
TH 20 S (PR-2B)	Mini Z8	574788	
TH 26 S (PR-2B)	Mini Z8	574794	
TH 32 S (PR-2B)	Mini Z8	574798	
U 16		578374	
U 18		578376	
U 20		578378	
U 25		578380	
U 32		578382	
U 40		578386	
BEGETUBE/ IVAR	B 14		578466
	B 16		578468
	B 18		578470
	B 20		578472
	B 26		578474
	B 32		578476
	B 32		578476
Béné inox Série 41	M 15		578312
	M 18		578314
	M 22		578316
	M 28		578318
	M 35		578390
	M 15 S (PR-2B)	Mini Z8	574738
	M 18 S (PR-2B)	Mini Z8	574740
	M 22 S (PR-2B)	Mini Z8	574742
	M 28 S (PR-2B)	Mini Z8	574744
	M 35 S (PR-2B)	Mini Z8	574746
Brass Form Master Press	H 16		578400
	H 18		578404
	H 20		578406
	TH 16		578352
	TH 18		578356
	TH 20		578358
	TH 16 S (PR-2B)	Mini Z8	574782
	TH 20 S (PR-2B)	Mini Z8	574788
	U 16		578374
	U 18		578376
U 20		578378	
Brass & Fittings PRESSMAN MultiPress	Rfz 16		578492
	Rfz 18		578638
	Acz 20		578612
	Rfz 25		578496
	Rfz 32		578498
Brass & Fittings PRESSMAN RetiPress	Rfz 16		578492
	Rfz 18		578638
	Acz 20		578612
	Rfz 25		578496
	Rfz 32		578498
BRASSTECH MULTIthermoSAN Brasspress	B 16		578468
	B 20		578472
	B 26		578474
	B 32		578476
	F 16		578456
	F 20		578460
	F 26		578462
	F 16 S (PR-2B)	Mini Z8	574728
	F 20 S (PR-2B)	Mini Z8	574730
	F 26 S (PR-2B)	Mini Z8	574732
	H 16		578400
	H 18		578404
	H 20		578406
	H 26		578410
TH 16		578352	
TH 18		578356	
TH 20		578358	
TH 26		578362	
TH 32		578364	
TH 40		578624	
TH 16 S (PR-2B)	Mini Z8	574782	
TH 20 S (PR-2B)	Mini Z8	574788	
TH 26 S (PR-2B)	Mini Z8	574794	
TH 32 S (PR-2B)	Mini Z8	574798	
U 16		578374	
U 18		578376	
U 20		578378	
C 26		578392	
U 32		578382	

REMS pressing tongs Mini

REMS pressing rings

Accessories for REMS radial presses 22 kN

System	Pressing tongs/ pressing rings	Driven by adapter tongs	Art.-No.
C			
Cello Products -B->Press	VUS ½" (OD 15,9 mm)		578566
	VUS ¾" (OD 22,2 mm)		578568
	VUS 1" (OD 28,6 mm)		578570
	VUS 1¼" (OD 34,9 mm)		578606
CGR DYNAFLU multicouche	H 16		578400
	H 20		578406
	H 26		578410
	H 32		578412
	TH 16		578352
	TH 20		578358
	TH 26		578362
	TH 32		578364
	TH 40		578624
	TH 16 S (PR-2B)	Mini Z8	574782
	TH 20 S (PR-2B)	Mini Z8	574788
	TH 26 S (PR-2B)	Mini Z8	574794
	TH 32 S (PR-2B)	Mini Z8	574798
	U 16		578374
	U 20		578378
	U 32		578382
U 40		578386	
CGR DYNAFLU PER	H 12		578396
	H 16		578400
	H 20		578406
	H 25		578408
	RFz 12		578490
RFz 16		578492	
RFz 20		578494	
RFz 25		578496	
CHIALI CHIALIPEX	TH 16		578352
	TH 20		578358
	TH 26		578362
	TH 32		578364
	TH 40		578624
Climatek Clima Therm	TH 14		578348
	TH 16		578352
	TH 18		578356
	TH 20		578358
	TH 26		578362
	TH 32		578364
Climatrix Climatrix Rhinopex	H 16		578400
	H 20		578406
	U 16		578374
	U 20		578378
	TH 14		578348
	TH 16		578352
	TH 18		578356
	TH 20		578358
	TH 26		578362
	TH 32		578364
	TH 16 S (PR-2B)	Mini Z8	574782
TH 20 S (PR-2B)	Mini Z8	574788	
TH 26 S (PR-2B)	Mini Z8	574794	
TH 32 S (PR-2B)	Mini Z8	574798	
Climatrix Variotherm System TH ClouSet	TH 11,6		578344
	TH 16		578352
	TH 16 S (PR-2B)	Mini Z8	574782
	TH 16		578352
TH 18		578356	
TH 20		578358	
TH 16 S (PR-2B)	Mini Z8	574782	
TH 20 S (PR-2B)	Mini Z8	574788	
Comap PEX Press	RFz 12		578490
	RFz 16		578492
	RFz 20		578494
	RFz 25		578496
	Comap Multiskin	TH 14	
TH 16			578352
TH 18			578356
TH 20			578358
TH 26			578362
TH 32			578364
THL 32			578368
TH 40			578624
TH 16 S (PR-2B)		Mini Z8	574782
TH 20 S (PR-2B)		Mini Z8	574788
TH 26 S (PR-2B)		Mini Z8	574794
TH 32 S (PR-2B)		Mini Z8	574798
U 14			578372
U 16			578374
U 18			578376
U 20			578378
U 32			578382
H 14			578398
H 16			578400
H 18			578404
H 20			578406
H 26		578410	
H 32		578412	

System	Pressing tongs/ pressing rings	Driven by adapter tongs	Art.-No.
Comap Multiskin Gas	TH 16		578352
	TH 20		578358
	TH 26		578362
	TH 32		578364
	THL 32		578368
	TH 16 S (PR-2B)	Mini Z8	574782
	TH 20 S (PR-2B)	Mini Z8	574788
	TH 26 S (PR-2B)	Mini Z8	574794
	TH 32 S (PR-2B)	Mini Z8	574798
	U 16		578374
	U 20		578378
	U 32		578382
	H 16		578400
	H 20		578406
	H 26		578410
	H 32		578412
COMISA Press System	TH 14		578348
	TH 16		578352
	TH 18		578356
	TH 20		578358
	TH 25		578360
	TH 26		578362
	TH 32		578364
	TH 40		578624
	TH 16 S (PR-2B)	Mini Z8	574782
	TH 20 S (PR-2B)	Mini Z8	574788
	TH 26 S (PR-2B)	Mini Z8	574794
	TH 32 S (PR-2B)	Mini Z8	574798
	H 14		578398
	H 16		578400
	H 18		578404
	H 20		578406
H 26		578410	
H 32		578412	
B 14		578466	
B 16		578468	
B 18		578470	
B 20		578472	
B 26		578474	
B 32		578476	
COMISA Press System Gas	TH 16		578352
	TH 20		578358
	TH 26		578362
	TH 32		578364
	TH 16 S (PR-2B)	Mini Z8	574782
	TH 20 S (PR-2B)	Mini Z8	574788
	TH 26 S (PR-2B)	Mini Z8	574794
	TH 32 S (PR-2B)	Mini Z8	574798
CONEL CONNECT MULTI	F 16		578456
	F 20		578460
	F 26		578462
	F 32		578464
	F 16 S (PR-2B)	Mini Z8	574728
	F 20 S (PR-2B)	Mini Z8	574730
	F 26 S (PR-2B)	Mini Z8	574732
	F 32 S (PR-2B)	Mini Z8	574734
	H 16		578400
	H 20		578406
	H 26		578410
	H 32		578412
	TH 16		578352
	TH 20		578358
TH 26		578362	
TH 32		578364	
TH 16 S (PR-2B)	Mini Z8	574782	
TH 20 S (PR-2B)	Mini Z8	574788	
TH 26 S (PR-2B)	Mini Z8	574794	
TH 32 S (PR-2B)	Mini Z8	574798	
U 16		578374	
U 20		578378	
(DN 26)		578380	
U 32		578382	
VP 16		578482	
VP 20		578484	
VP 32		578488	
CONEL CONNECT MV2	F 16		578456
	F 20		578460
	F 26		578462
	F 32		578464
	F 16 S (PR-2B)	Mini Z8	574728
	F 20 S (PR-2B)	Mini Z8	574730
	F 26 S (PR-2B)	Mini Z8	574732
	F 32 S (PR-2B)	Mini Z8	574734
	TH 16		578352
	TH 20		578358
	TH 26		578362
	TH 32		578364
	TH 16 S (PR-2B)	Mini Z8	574782
	TH 20 S (PR-2B)	Mini Z8	574788
TH 26 S (PR-2B)	Mini Z8	574794	
TH 32 S (PR-2B)	Mini Z8	574798	

Pressfitting systems for gas installations must only be pressed with REMS pressing tongs Mini/pressing rings which are highlighted in yellow.

Observe the national regulations. Read and observe the instructions for use and the installation instructions of the system provider/manufacturer.

- 1) Only pressing tongs from designation "108" (1st quarter of 2008), "208" (2nd quarter of 2008) etc. can be used. The designation is stamped on every pressing jaw.
- 2) For taking suitable pressing inserts.
- 3) Only pressing tongs from designation "117" (1st quarter of 2017), "217" (2nd quarter of 2017) etc. can be used. The designation is stamped on every pressing jaw.
- 4) For pipes of the EN technical standard. Observe the instructions for use of the system provider/manufacturer.
- 5) For pipes of the ASTM technical standard. Observe the instructions for use of the system provider/manufacturer.

The suitability of REMS pressing tools for pressfitting systems: Date 12.10.2022. For the updated situation regarding suitability status check our website:

www.rems.de > Downloads > Product catalogues, brochures > REMS Catalogue.

See page 180 for adapter tongs. Pressing tongs for additional pressfitting systems on request.

System	Pressing tongs / pressing rings	Driven by adapter tongs	Art.-No.
Conex Bänninger >B< Flex	F 16		578456
	F 18		578458
	F 20		578460
	F 32		578464
	F 16 S (PR-2B)	Mini Z8	574728
	F 20 S (PR-2B)	Mini Z8	574730
	F 32 S (PR-2B)	Mini Z8	574734
	H 16		578400
	H 18		578404
	H 20		578406
	H 25		578408
	H 32		578412
	RFz 16		578492
	RFz 18		578638
	RFz 20		578494
	RFz 25		578496
	RFz 32		578498
	TH 16		578352
	TH 18		578356
	TH 20		578358
	TH 25		578360
	TH 32		578364
	U 16		578374
	U 18		578376
	U 20		578378
	U 25		578380
	U 32		578382
Conex Bänninger >B< MaxiPro	BMP ¼"		578700
	BMP ⅜"		578702
	BMP ½"		578704
	BMP ⅝"		578706
	BMP ¾"		578708
	BMP 1"		578710
	BMP 1 ¼"		578712
	BMP 1 ½"		578714
Conex Bänninger >B< Press	V 12		578324
	V 14		578326
	V 15		578328
	V 16		578330
	V 18		578332
	V 22		578334
	V 28		578336
	V 35		578604
	V 12 S (PR-2B)	Mini Z8	574748
	V 14 S (PR-2B)	Mini Z8	574800
	V 15 S (PR-2B)	Mini Z8	574752
	V 16 S (PR-2B)	Mini Z8	574802
	V 18 S (PR-2B)	Mini Z8	574756
	V 22 S (PR-2B)	Mini Z8	574758
V 28 S (PR-2B)	Mini Z8	574760	
V 35 S (PR-2B)	Mini Z8	574762	
Conex Bänninger >B< Press Carbon	V 15		578328
	V 18		578332
	V 22		578334
	V 28		578336
	V 35		578604
	V 15 S (PR-2B)	Mini Z8	574752
	V 18 S (PR-2B)	Mini Z8	574756
	V 22 S (PR-2B)	Mini Z8	574758
	V 28 S (PR-2B)	Mini Z8	574760
	V 35 S (PR-2B)	Mini Z8	574762
Conex Bänninger >B< Press Gas	V 12		578324
	V 14		578326
	V 15		578328
	V 16		578330
	V 18		578332
	V 22		578334
	V 28		578336
	V 35		578604
	V 12 S (PR-2B)	Mini Z8	574748
	V 14 S (PR-2B)	Mini Z8	574800
	V 15 S (PR-2B)	Mini Z8	574752
	V 16 S (PR-2B)	Mini Z8	574802
	V 18 S (PR-2B)	Mini Z8	574756
	V 22 S (PR-2B)	Mini Z8	574758
V 28 S (PR-2B)	Mini Z8	574760	
V 35 S (PR-2B)	Mini Z8	574762	
Conex Bänninger >B< Press Inox	V 15		578328
	V 18		578332
	V 22		578334
	V 28		578336
	V 35		578604
	V 15 S (PR-2B)	Mini Z8	574752
	V 18 S (PR-2B)	Mini Z8	574756
	V 22 S (PR-2B)	Mini Z8	574758
	V 28 S (PR-2B)	Mini Z8	574760
	V 35 S (PR-2B)	Mini Z8	574762
Conex Bänninger >B< Press Solar	V 12		578324
	V 14		578326
	V 15		578328
	V 16		578330
	V 18		578332
	V 22		578334
	V 28		578336
	V 35		578604
	V 12 S (PR-2B)	Mini Z8	574748
	V 14 S (PR-2B)	Mini Z8	574800
	V 15 S (PR-2B)	Mini Z8	574752
	V 16 S (PR-2B)	Mini Z8	574802
	V 18 S (PR-2B)	Mini Z8	574756
	V 22 S (PR-2B)	Mini Z8	574758
V 28 S (PR-2B)	Mini Z8	574760	
V 35 S (PR-2B)	Mini Z8	574762	

System	Pressing tongs / pressing rings	Driven by adapter tongs	Art.-No.	
D				
Debrunner Acifer d-a Presssystem C-Stahl	M 12		578310	
	M 15		578312	
	M 18		578314	
	M 22		578316	
	M 28		578318	
	M 35		578390	
	M 12 S (PR-2B)	Mini Z8	574736	
	M 15 S (PR-2B)	Mini Z8	574738	
	M 18 S (PR-2B)	Mini Z8	574740	
	M 22 S (PR-2B)	Mini Z8	574742	
	M 28 S (PR-2B)	Mini Z8	574744	
M 35 S (PR-2B)	Mini Z8	574746		
DIWAsystems	TH 14		578348	
	TH 16		578352	
	TH 20		578358	
	TH 26		578362	
	TH 32		578364	
TH 40		578624		
DUOPIPE Systems DUOFIL MKSYSTEM	U 16		578374	
	U 18		578376	
	U 20		578378	
	U 25		578380	
	U 32		578382	
DW Verbundrohr multitubo systems	U 16		578374	
	U 18		578376	
	U 20		578378	
	U 25		578380	
	U 32		578382	
E				
EBRILLE Isomomflex	U 16		578374	
	U 20		578378	
	U 25		578380	
	H 26		578410	
	TH 26		578362	
	TH 26 S (PR-2B)	Mini Z8	574794	
U 32		578382		
EBRILLE Monflex	U 16		578374	
	U 20		578378	
	U 25		578380	
	H 26		578410	
	TH 26		578362	
	TH 26 S (PR-2B)	Mini Z8	574794	
U 32		578382		
EFFEBI EFFEBI-PRESS Aisi316 System M Profile ¹⁾	M 15		578312	
	M 18		578314	
	M 22		578316	
	M 28		578318	
	M 35		578390	
	M 15 S (PR-2B)	Mini Z8	574738	
	M 18 S (PR-2B)	Mini Z8	574740	
	M 22 S (PR-2B)	Mini Z8	574742	
	M 28 S (PR-2B)	Mini Z8	574744	
	M 35 S (PR-2B)	Mini Z8	574746	
EFFEBI EFFEBI-PRESS Aisi316 System V Profile	V 12		578324	
	V 15		578328	
	V 18		578332	
	V 22		578334	
	V 28		578336	
	V 35		578604	
	V 12 S (PR-2B)	Mini Z8	574748	
	V 15 S (PR-2B)	Mini Z8	574752	
	V 18 S (PR-2B)	Mini Z8	574756	
	V 22 S (PR-2B)	Mini Z8	574758	
	V 28 S (PR-2B)	Mini Z8	574760	
	V 35 S (PR-2B)	Mini Z8	574762	
	EFFEBI EFFEBI-PRESS Carbon-S System M Profile ¹⁾	M 12		578310
		M 15		578312
M 18			578314	
M 22			578316	
M 28			578318	
M 35			578390	
M 12 S (PR-2B)		Mini Z8	574736	
M 15 S (PR-2B)		Mini Z8	574738	
M 18 S (PR-2B)		Mini Z8	574740	
M 22 S (PR-2B)		Mini Z8	574742	
M 28 S (PR-2B)	Mini Z8	574744		
M 35 S (PR-2B)	Mini Z8	574746		
EFFEBI EFFEBI-PRESS Carbon-S System V Profile	V 12		578324	
	V 15		578328	
	V 18		578332	
	V 22		578334	
	V 28		578336	
	V 35		578604	
	V 12 S (PR-2B)	Mini Z8	574748	
	V 15 S (PR-2B)	Mini Z8	574752	
	V 18 S (PR-2B)	Mini Z8	574756	
	V 22 S (PR-2B)	Mini Z8	574758	
	V 28 S (PR-2B)	Mini Z8	574760	
	V 35 S (PR-2B)	Mini Z8	574762	

REMS pressing tongs Mini

REMS pressing rings

Accessories for REMS radial presses 22 kN

System	Pressing tongs/ pressing rings	Driven by adapter tongs	Art.-No.
EFFEBI EFFEBI-PRESS UNICO	V 12		578324
	V 15		578328
	V 18		578332
	V 22		578334
	V 28		578336
	V 35		578604
	V 12 S (PR-2B)	Mini Z8	574748
	V 15 S (PR-2B)	Mini Z8	574752
	V 18 S (PR-2B)	Mini Z8	574756
	V 22 S (PR-2B)	Mini Z8	574758
	V 28 S (PR-2B)	Mini Z8	574760
	V 35 S (PR-2B)	Mini Z8	574762
	EFFEBI EFFEBI-PRESS UNICO ⁴⁾ (GAS)	V 12	
V 15			578328
V 18			578332
V 22			578334
V 28			578336
V 35			578604
V 12 S (PR-2B)		Mini Z8	574748
V 15 S (PR-2B)		Mini Z8	574752
V 18 S (PR-2B)		Mini Z8	574756
V 22 S (PR-2B)		Mini Z8	574758
V 28 S (PR-2B)		Mini Z8	574760
V 35 S (PR-2B)		Mini Z8	574762
EFFEBI PRESSTIGE		M 15	
	M 18		578314
	M 22		578316
	M 28		578318
	M 35		578390
	M 15 S (PR-2B)	Mini Z8	574738
	M 18 S (PR-2B)	Mini Z8	574740
	M 22 S (PR-2B)	Mini Z8	574742
	M 28 S (PR-2B)	Mini Z8	574744
	M 35 S (PR-2B)	Mini Z8	574746
	V 15		578328
	V 18		578332
	V 22		578334
	V 28		578336
	V 35		578604
	V 15 S (PR-2B)	Mini Z8	574752
	V 18 S (PR-2B)	Mini Z8	574756
	V 22 S (PR-2B)	Mini Z8	574758
	V 28 S (PR-2B)	Mini Z8	574760
V 35 S (PR-2B)	Mini Z8	574762	
EFFEBI PRESSTIGE 4E05	M 15		578312
	M 18		578314
	M 22		578316
	M 28		578318
	M 35		578390
	M 15 S (PR-2B)	Mini Z8	574738
	M 18 S (PR-2B)	Mini Z8	574740
	M 22 S (PR-2B)	Mini Z8	574742
	M 28 S (PR-2B)	Mini Z8	574744
	M 35 S (PR-2B)	Mini Z8	574746
EFFEBI PRESSTIGE-GAS ⁴⁾	M 15		578312
	M 18		578314
	M 22		578316
	M 28		578318
	M 35		578390
	M 15 S (PR-2B)	Mini Z8	574738
	M 18 S (PR-2B)	Mini Z8	574740
	M 22 S (PR-2B)	Mini Z8	574742
	M 28 S (PR-2B)	Mini Z8	574744
	M 35 S (PR-2B)	Mini Z8	574746
	V 15		578328
	V 18		578332
	V 22		578334
V 28		578336	
V 35		578604	
V 15 S (PR-2B)	Mini Z8	574752	
V 18 S (PR-2B)	Mini Z8	574756	
V 22 S (PR-2B)	Mini Z8	574758	
V 28 S (PR-2B)	Mini Z8	574760	
V 35 S (PR-2B)	Mini Z8	574762	
EFFEBI TOF-GAS MULTIPINZA	TH 16		578352
	TH 20		578358
	TH 26		578362
	TH 32		578364
	TH 16 S (PR-2B)	Mini Z8	574782
	TH 20 S (PR-2B)	Mini Z8	574788
	TH 26 S (PR-2B)	Mini Z8	574794
	TH 32 S (PR-2B)	Mini Z8	574798
	H 16		578400
	H 20		578406
	H 26		578410
	H 32		578412
	U 16		578374
	U 20		578378
	U 32		578382

System	Pressing tongs/ pressing rings	Driven by adapter tongs	Art.-No.
EFFEBI TOF MULTIPINZA	TH 16		578352
	TH 18		578356
	TH 20		578358
	TH 26		578362
	TH 32		578364
	TH 40		578624
	TH 16 S (PR-2B)	Mini Z8	574782
	TH 20 S (PR-2B)	Mini Z8	574788
	TH 26 S (PR-2B)	Mini Z8	574794
	TH 32 S (PR-2B)	Mini Z8	574798
	F 16		578456
	F 18		578458
	F 20		578460
	F 26		578462
	F 32		578464
	Fz 40		578478
	F 16 S (PR-2B)	Mini Z8	574728
	F 20 S (PR-2B)	Mini Z8	574730
	F 26 S (PR-2B)	Mini Z8	574732
	F 32 S (PR-2B)	Mini Z8	574734
	H 16		578400
	H 18		578404
	H 20		578406
	H 26		578410
	H 32		578412
	U 16		578374
	U 18		578376
U 20		578378	
U 25		578380	
C 26		578392	
U 32		578382	
U 40		578386	
B 16		578468	
B 18		578470	
B 20		578472	
B 26		578474	
B 32		578476	
EFIELD MULTILAYER PRESS DINGAS	U 16		578374
	U 18		578376
	U 20		578378
	U 25		578380
	U 32		578382
EFIELD MULTILAYER PRESS WATER	U 16		578374
	U 18		578376
	U 20		578378
	U 25		578380
	U 32		578382
Elkhart APOLLOXPRESS Fittings Copper and Low-Lead Brass	VUS ½" (OD 15,9 mm)		578566
	VUS ¾" (OD 22,2 mm)		578568
	VUS 1" (OD 28,6 mm)		578570
	VUS 1¼" (OD 34,9 mm)		578606
	ELYDAN izeo	RFz 16	
RFz 20		578494	
RFz 25		578496	
RFz 32		578498	
U 16		578374	
U 20		578378	
U 25		578380	
U 32		578382	
EMMETI GERPEX- FIVPRESS	B 16		578468
	B 20		578472
	B 26		578474
	B 32		578476
	F 16		578456
	F 20		578460
	H 16		578400
	H 20		578406
	TH 16		578352
	TH 20		578358
	TH 26		578362
	TH 32		578364
	TH 40		578624
U 16		578374	
U 20		578378	
EMPUR	TH 14		578348
	TH 15		578350
	TH 16		578352
	TH 17		578354
	TH 20		578358
	TH 25		578360
	TH 16 S (PR-2B)	Mini Z8	574782
TH 20 S (PR-2B)	Mini Z8	574788	
Esta Rohr simplesta SH M	M 15		578312
	M 18		578314
	M 22		578316
	M 28		578318
	M 35		578390
	M 15 S (PR-2B)	Mini Z8	574738
	M 18 S (PR-2B)	Mini Z8	574740
	M 22 S (PR-2B)	Mini Z8	574742
M 28 S (PR-2B)	Mini Z8	574744	
M 35 S (PR-2B)	Mini Z8	574746	

Pressfitting systems for gas installations must only be pressed with REMS pressing tongs Mini/pressing rings which are highlighted in yellow.

Observe the national regulations. Read and observe the instructions for use and the installation instructions of the system provider/manufacturer.

- Only pressing tongs from designation "108" (1st quarter of 2008), "208" (2nd quarter of 2008) etc. can be used. The designation is stamped on every pressing jaw.
- For taking suitable pressing inserts.
- Only pressing tongs from designation "117" (1st quarter of 2017), "217" (2nd quarter of 2017) etc. can be used. The designation is stamped on every pressing jaw.
- For pipes of the EN technical standard. Observe the instructions for use of the system provider/manufacturer.
- For pipes of the ASTM technical standard. Observe the instructions for use of the system provider/manufacturer.

The suitability of REMS pressing tools for pressfitting systems: Date 12.10.2022. For the updated situation regarding suitability status check our website: www.rems.de > Downloads > Product catalogues, brochures > REMS Catalogue.

See page 180 for adapter tongs. Pressing tongs for additional pressfitting systems on request.

REMS pressing tongs Mini REMS pressing rings

Accessories for REMS radial presses 22 kN

System	Pressing tongs / pressing rings	Driven by adapter tongs	Art.-No.
Esta Rohr simplesta ST M	M 15		578312
	M 18		578314
	M 22		578316
	M 28		578318
	M 35		578390
	M 15 S (PR-2B)	Mini Z8	574738
	M 18 S (PR-2B)	Mini Z8	574740
	M 22 S (PR-2B)	Mini Z8	574742
	M 28 S (PR-2B)	Mini Z8	574744
	M 35 S (PR-2B)	Mini Z8	574746
EUROTUBI	M 12		578310
EUROPA	M 15		578312
C-Steel Pressfitting System M-Profile ¹⁾	M 18		578314
	M 22		578316
	M 28		578318
	M 35		578390
	M 12 S (PR-2B)	Mini Z8	574736
	M 15 S (PR-2B)	Mini Z8	574738
	M 18 S (PR-2B)	Mini Z8	574740
	M 22 S (PR-2B)	Mini Z8	574742
	M 28 S (PR-2B)	Mini Z8	574744
	M 35 S (PR-2B)	Mini Z8	574746
EUROTUBI	M 15		578312
EUROPA	M 18		578314
Inox Pressfitting System M-Profile ¹⁾	M 22		578316
	M 28		578318
	M 35		578390
	M 15 S (PR-2B)	Mini Z8	574738
	M 18 S (PR-2B)	Mini Z8	574740
	M 22 S (PR-2B)	Mini Z8	574742
	M 28 S (PR-2B)	Mini Z8	574744
M 35 S (PR-2B)	Mini Z8	574746	
Evans Components Presslok	VAU 15 (½")		578630
	VAU 20 (¾")		578632
	VAU 25 (1")		578634
F			
FAR Rubinetterie PRESSFAR	TH 14		578348
	TH 16		578352
	TH 17		578354
	TH 18		578356
	TH 20		578358
	TH 25		578360
	TH 26		578362
	TH 32		578364
	TH 40		578624
	TH 16 S (PR-2B)	Mini Z8	574782
	TH 20 S (PR-2B)	Mini Z8	574788
	TH 26 S (PR-2B)	Mini Z8	574794
	TH 32 S (PR-2B)	Mini Z8	574798
	H 14		578398
	H 16		578400
	H 18		578404
	H 20		578406
	H 26		578410
	H 32		578412
	U 14		578372
	U 16		578374
	U 18		578376
	U 20		578378
	U 25		578380
	U 32		578382
U 40		578386	
F.B.Q. BARONIO BQ PRESS SOLAR	V 12		578324
	V 15		578328
	V 18		578332
	V 22		578334
	V 28		578336
	V 35		578604
	V 12 S (PR-2B)	Mini Z8	574748
	V 15 S (PR-2B)	Mini Z8	574752
	V 18 S (PR-2B)	Mini Z8	574756
	V 22 S (PR-2B)	Mini Z8	574758
	V 28 S (PR-2B)	Mini Z8	574760
	V 35 S (PR-2B)	Mini Z8	574762
F.B.Q. BARONIO BQ PRESS WATER	V 12		578324
	V 15		578328
	V 18		578332
	V 22		578334
	V 28		578336
	V 35		578604
	V 12 S (PR-2B)	Mini Z8	574748
	V 15 S (PR-2B)	Mini Z8	574752
	V 18 S (PR-2B)	Mini Z8	574756
	V 22 S (PR-2B)	Mini Z8	574758
	V 28 S (PR-2B)	Mini Z8	574760
	V 35 S (PR-2B)	Mini Z8	574762
F.B.Q. BARONIO BQ PRESS C-STEEL	V 15		578328
	V 18		578332
	V 22		578334
	V 28		578336
	V 35		578604
	V 15 S (PR-2B)	Mini Z8	574752
	V 18 S (PR-2B)	Mini Z8	574756
	V 22 S (PR-2B)	Mini Z8	574758
	V 28 S (PR-2B)	Mini Z8	574760
	V 35 S (PR-2B)	Mini Z8	574762

System	Pressing tongs / pressing rings	Driven by adapter tongs	Art.-No.	
F.B.Q. BARONIO BQ PRESS GAS	V 12		578324	
	V 15		578328	
	V 18		578332	
	V 22		578334	
	V 28		578336	
	V 35		578604	
	V 12 S (PR-2B)	Mini Z8	574748	
	V 15 S (PR-2B)	Mini Z8	574752	
	V 18 S (PR-2B)	Mini Z8	574756	
	V 22 S (PR-2B)	Mini Z8	574758	
	V 28 S (PR-2B)	Mini Z8	574760	
	V 35 S (PR-2B)	Mini Z8	574762	
Fercofloor DUO Press FERCO PEX	RFz 16		578492	
	RFz 20		578494	
	RFz 25		578496	
	RFz 32		578498	
	TH 16		578352	
	TH 20		578358	
	TH 25		578360	
	TH 32		578364	
	TH 40		578624	
	TH 16 S (PR-2B)	Mini Z8	574782	
TH 20 S (PR-2B)	Mini Z8	574788		
TH 32 S (PR-2B)	Mini Z8	574798		
Fercofloor DUO Press MULTIFER	RFz 16		578492	
	RFz 20		578494	
	RFz 25		578496	
	RFz 32		578498	
	TH 16		578352	
	TH 20		578358	
	TH 25		578360	
	TH 32		578364	
	TH 40		578624	
	TH 16 S (PR-2B)	Mini Z8	574782	
TH 20 S (PR-2B)	Mini Z8	574788		
TH 32 S (PR-2B)	Mini Z8	574798		
FERRO systems BRASELLI GPF GAS	TH 16		578352	
	TH 20		578358	
	TH 25		578360	
	TH 32		578364	
	TH 16 S (PR-2B)	Mini Z8	574782	
	TH 20 S (PR-2B)	Mini Z8	574788	
	TH 25 S (PR-2B)	Mini Z8	574792	
	TH 32 S (PR-2B)	Mini Z8	574798	
	FERRO systems BRASELLI GPF MULT Pressfitting MULTICAPA	U 16		578374
		U 18		578376
U 20			578378	
U 25			578380	
U 32			578382	
U 40			578386	
FERRO systems BRASELLI GPF PPSU Pressfitting PEX y MULTICAPA		U 16		578374
		U 18		578376
		U 20		578378
		U 25		578380
	U 32		578382	
	U 40		578386	
	FERRO systems BRASELLI GPF PRESS Pressfitting PEX FILINOX Instalpress Steel	RFz 16		578492
		RFz 20		578494
		RFz 25		578496
		RFz 32		578498
M 15			578312	
M 18			578314	
M 22			578316	
M 28			578318	
M 35			578390	
M 15 S (PR-2B)		Mini Z8	574738	
M 18 S (PR-2B)	Mini Z8	574740		
M 22 S (PR-2B)	Mini Z8	574742		
M 28 S (PR-2B)	Mini Z8	574744		
M 35 S (PR-2B)	Mini Z8	574746		
FILINOX Instalpress Inox	M 15		578312	
	M 18		578314	
	M 22		578316	
	M 28		578318	
	M 35		578390	
	M 15 S (PR-2B)	Mini Z8	574738	
Fittings Estándar ECO-PRESS	RFz 16		578492	
	RFz 20		578494	
	RFz 25		578496	
	RFz 32		578498	
	Fittings Estándar MULTICAPA	RFz 16		578492
		RFz 18		578638
		RFz 20		578494
		RFz 25		578496
		RFz 32		578498

System	Pressing tongs/ pressing rings	Driven by adapter tongs	Art.-No.	
Fittings Estándar PE-X	RFz 16		578492	
	RFz 20		578494	
	RFz 25		578496	
	RFz 32		578498	
FORNARA ForPress	B 16		578468	
	B 20		578472	
	B 26		578474	
	B 32		578476	
	F 16		578456	
	F 20		578460	
	F 26		578462	
	F 32		578464	
	F 16 S (PR-2B)	Mini Z8	574728	
	F 20 S (PR-2B)	Mini Z8	574730	
	F 26 S (PR-2B)	Mini Z8	574732	
	F 32 S (PR-2B)	Mini Z8	574734	
	H 16		578400	
	H 20		578406	
	H 26		578410	
	H 32		578412	
	TH 16		578352	
	TH 20		578358	
	TH 26		578362	
	TH 32		578364	
	TH 16 S (PR-2B)	Mini Z8	574782	
	TH 20 S (PR-2B)	Mini Z8	574788	
	TH 26 S (PR-2B)	Mini Z8	574794	
	TH 32 S (PR-2B)	Mini Z8	574798	
	U 16		578374	
	U 20		578378	
	C 26		578392	
	U 32		578382	
	FORZA WATER CRIMP (AUS)	K16/P18		578592
		K/20		578594
		K/25		578596
		K32		578598
FORZA STAINLESS WATER CRIMP	K16/P18		578592	
	K/20		578594	
	FORZA STESSO PEX WATER AND GAS CRIMP AUS)	U 16		578374
		U 20		578378
U 25			578380	
U 32			578382	
FORZA GAS CRIMP (AUS)	U 40		578386	
	K16/P18		578592	
	K/20		578594	
	K/25		578596	
FORZA COPPER V PRESS (AUS)	K32		578598	
	K1/40		578600	
	VAU 15 (OD 12,7 mm)		578630	
	VAU 20 (OD 19,1 mm)		578632	
	VAU 25 (OD 25,4 mm)		578634	
	VAU 32 (OD 31,8 mm)		578636	
FORZA STAINLESS V PRESS (AUS)	VAU 15 S (PR-2B) (OD 12,7 mm)	Mini Z8	574804	
	VAU 20 S (PR-2B) (OD 19,1 mm)	Mini Z8	574806	
	VAU 25 S (PR-2B) (OD 25,4 mm)	Mini Z8	574808	
	V 15		578328	
	V 22		578334	
	V 28		578336	
	V 35		578604	
	V 15 S (PR-2B)	Mini Z8	574752	
V 22 S (PR-2B)	Mini Z8	574758		
V 28 S (PR-2B)	Mini Z8	574760		
V 35 S (PR-2B)	Mini Z8	574762		
FRABO FRABOPRESS 316 GAS M	M 15		578312	
	M 18		578314	
	M 22		578316	
	M 28		578318	
	M 35		578390	
	M 15 S (PR-2B)	Mini Z8	574738	
	M 18 S (PR-2B)	Mini Z8	574740	
	M 22 S (PR-2B)	Mini Z8	574742	
	M 28 S (PR-2B)	Mini Z8	574744	
	M 35 S (PR-2B)	Mini Z8	574746	

System	Pressing tongs/ pressing rings	Driven by adapter tongs	Art.-No.	
FRABO FRABOPRESS 316 GAS V	V 15		578328	
	V 18		578332	
	V 22		578334	
	V 28		578336	
	V 35		578604	
	V 15 S (PR-2B)	Mini Z8	574752	
	V 18 S (PR-2B)	Mini Z8	574756	
	V 22 S (PR-2B)	Mini Z8	574758	
	V 28 S (PR-2B)	Mini Z8	574760	
	V 35 S (PR-2B)	Mini Z8	574762	
	FRABO FRABOPRESS 316 M	M 15		578312
		M 18		578314
M 22			578316	
M 28			578318	
M 35			578390	
M 15 S (PR-2B)		Mini Z8	574738	
M 18 S (PR-2B)		Mini Z8	574740	
M 22 S (PR-2B)		Mini Z8	574742	
M 28 S (PR-2B)		Mini Z8	574744	
M 35 S (PR-2B)		Mini Z8	574746	
FRABO FRABOPRESS 316 V		V 12		578324
		V 15		578328
	V 18		578332	
	V 22		578334	
	V 28		578336	
	V 35		578604	
	V 12 S (PR-2B)	Mini Z8	574748	
	V 15 S (PR-2B)	Mini Z8	574752	
	V 18 S (PR-2B)	Mini Z8	574756	
	V 22 S (PR-2B)	Mini Z8	574758	
	V 28 S (PR-2B)	Mini Z8	574760	
	V 35 S (PR-2B)	Mini Z8	574762	
FRABO FRABOPRESS CHROME	V 12		578324	
	V 15		578328	
	V 18		578332	
	V 22		578334	
	V 12 S (PR-2B)	Mini Z8	574748	
	V 15 S (PR-2B)	Mini Z8	574752	
	V 18 S (PR-2B)	Mini Z8	574756	
	V 22 S (PR-2B)	Mini Z8	574758	
	FRABO FRABOPRESS C-STEEL M	M 15		578312
		M 18		578314
		M 22		578316
		M 28		578318
M 35			578390	
M 15 S (PR-2B)		Mini Z8	574738	
M 18 S (PR-2B)		Mini Z8	574740	
M 22 S (PR-2B)		Mini Z8	574742	
M 28 S (PR-2B)		Mini Z8	574744	
M 35 S (PR-2B)		Mini Z8	574746	
FRABO FRABOPRESS C-STEEL V		V 12		578324
		V 15		578328
	V 18		578332	
	V 22		578334	
	V 28		578336	
	V 35		578604	
	V 12 S (PR-2B)	Mini Z8	574748	
	V 15 S (PR-2B)	Mini Z8	574752	
	V 18 S (PR-2B)	Mini Z8	574756	
	V 22 S (PR-2B)	Mini Z8	574758	
	V 28 S (PR-2B)	Mini Z8	574760	
	V 35 S (PR-2B)	Mini Z8	574762	
FRABO FRABOPRESS GAS M	M 12		578310	
	M 15		578312	
	M 18		578314	
	M 22		578316	
	M 28		578318	
	M 35		578390	
	M 12 S (PR-2B)	Mini Z8	574736	
	M 15 S (PR-2B)	Mini Z8	574738	
	M 18 S (PR-2B)	Mini Z8	574740	
	M 22 S (PR-2B)	Mini Z8	574742	
	M 28 S (PR-2B)	Mini Z8	574744	
	M 35 S (PR-2B)	Mini Z8	574746	

Pressfitting systems for gas installations must only be pressed with REMS pressing tongs Mini/pressing rings which are highlighted in yellow.

Observe the national regulations. Read and observe the instructions for use and the installation instructions of the system provider/manufacturer.

- 1) Only pressing tongs from designation "108" (1st quarter of 2008), "208" (2nd quarter of 2008) etc. can be used. The designation is stamped on every pressing jaw.
- 2) For taking suitable pressing inserts.
- 3) Only pressing tongs from designation "117" (1st quarter of 2017), "217" (2nd quarter of 2017) etc. can be used. The designation is stamped on every pressing jaw.
- 4) For pipes of the EN technical standard. Observe the instructions for use of the system provider/manufacturer.
- 5) For pipes of the ASTM technical standard. Observe the instructions for use of the system provider/manufacturer.

The suitability of REMS pressing tools for pressfitting systems: Date 12.10.2022. For the updated situation regarding suitability status check our website: www.rems.de > Downloads > Product catalogues, brochures > REMS Catalogue.

See page 180 for adapter tongs. Pressing tongs for additional pressfitting systems on request.

REMS pressing tongs Mini REMS pressing rings

Accessories for REMS radial presses 22 kN

System	Pressing tongs / pressing rings	Driven by adapter tongs	Art.-No.
FRABO FRABOPRESS GAS V	V 12		578324
	V 15		578328
	V 18		578332
	V 22		578334
	V 28		578336
	V 35		578604
	V 12 S (PR-2B)	Mini Z8	574748
	V 15 S (PR-2B)	Mini Z8	574752
	V 18 S (PR-2B)	Mini Z8	574756
	V 22 S (PR-2B)	Mini Z8	574758
FRABO FRABOPRESS KOMBI	V 12		578324
	V 15		578328
	V 18		578332
	V 22		578334
	V 28		578336
	V 35		578604
	V 12 S (PR-2B)	Mini Z8	574748
	V 15 S (PR-2B)	Mini Z8	574752
	V 18 S (PR-2B)	Mini Z8	574756
	V 22 S (PR-2B)	Mini Z8	574758
FRABO FRABOPRESS M	M 12		578310
	M 15		578312
	M 18		578314
	M 22		578316
	M 28		578318
	M 35		578390
	M 12 S (PR-2B)	Mini Z8	574736
	M 15 S (PR-2B)	Mini Z8	574738
	M 18 S (PR-2B)	Mini Z8	574740
	M 22 S (PR-2B)	Mini Z8	574742
FRABO FRABOPRESS SOLAR	V 15		578328
	V 18		578332
	V 22		578334
	V 28		578336
	V 35		578604
	V 15 S (PR-2B)	Mini Z8	574752
	V 18 S (PR-2B)	Mini Z8	574756
	V 22 S (PR-2B)	Mini Z8	574758
	V 28 S (PR-2B)	Mini Z8	574760
	V 35 S (PR-2B)	Mini Z8	574762
FRABO FRABOPRESS V	V 12		578324
	V 15		578328
	V 18		578332
	V 22		578334
	V 28		578336
	V 35		578604
	V 12 S (PR-2B)	Mini Z8	574748
	V 15 S (PR-2B)	Mini Z8	574752
	V 18 S (PR-2B)	Mini Z8	574756
	V 22 S (PR-2B)	Mini Z8	574758
Fränkische alpex-duo XS	F 16		578456
	F 20		578460
	F 26		578462
	F 32		578464
	F 16 S (PR-2B)	Mini Z8	574728
	F 20 S (PR-2B)	Mini Z8	574730
	F 26 S (PR-2B)	Mini Z8	574732
	F 32 S (PR-2B)	Mini Z8	574734
	TH 16		578352
	TH 20		578358
Fränkische alpex F50 PROFIL	F 16		578456
	F 20		578460
	F 26		578462
	F 32		578464
	F 16 S (PR-2B)	Mini Z8	574728
	F 20 S (PR-2B)	Mini Z8	574730
	F 26 S (PR-2B)	Mini Z8	574732
	F 32 S (PR-2B)	Mini Z8	574734
	H 16		578400
	H 20		578406
(DN 26)	H 26		578410
	H 32		578412
	TH 16		578352
	TH 20		578358
	TH 26		578362
	TH 32		578364
	TH 16 S (PR-2B)	Mini Z8	574782
	TH 20 S (PR-2B)	Mini Z8	574788
	TH 26 S (PR-2B)	Mini Z8	574794
	TH 32 S (PR-2B)	Mini Z8	574798
Fränkische alpex L	Fz 40		578478

System	Pressing tongs / pressing rings	Driven by adapter tongs	Art.-No.
G			
gabotherm H+S	TH 10		578342
	TH 12		578346
	TH 14		578348
	TH 15		578350
	TH 16		578352
	TH 17		578354
	TH 18		578356
	TH 20		578358
	TH 25		578360
	TH 26		578362
	TH 32		578364
	TH 40		578624
	TH 16 S (PR-2B)	Mini Z8	574782
	TH 20 S (PR-2B)	Mini Z8	574788
	TH 26 S (PR-2B)	Mini Z8	574794
	TH 32 S (PR-2B)	Mini Z8	574798
Gallagher USA YogaPipe ACR	H 12 (1/4")		578396
	U 14 (3/8")		578372
	U 16 (1/2")		578374
	U 18 (5/8")		578376
	U 20 (3/4")		578378
	U 25 (7/8")		578380
Geberit Mapress C-STAHl	M 12		578310
	M 15		578312
	M 18		578314
	M 22		578316
	M 28		578318
	M 35		578390
	M 12 S (PR-2B)	Mini Z8	574736
	M 15 S (PR-2B)	Mini Z8	574738
	M 18 S (PR-2B)	Mini Z8	574740
	M 22 S (PR-2B)	Mini Z8	574742
Geberit Mapress Edelstahl	M 12		578310
	M 15		578312
	M 18		578314
	M 22		578316
	M 28		578318
	M 35		578390
	M 12 S (PR-2B)	Mini Z8	574736
	M 15 S (PR-2B)	Mini Z8	574738
	M 18 S (PR-2B)	Mini Z8	574740
	M 22 S (PR-2B)	Mini Z8	574742
Geberit Mapress Edelstahl Gas	M 15		578312
	M 18		578314
	M 22		578316
	M 28		578318
	M 35		578390
	M 15 S (PR-2B)	Mini Z8	574738
	M 18 S (PR-2B)	Mini Z8	574740
	M 22 S (PR-2B)	Mini Z8	574742
	M 28 S (PR-2B)	Mini Z8	574744
	M 35 S (PR-2B)	Mini Z8	574746
Geberit Mapress Kupfer	M 12		578310
	M 15		578312
	M 18		578314
	M 22		578316
	M 28		578318
	M 35		578390
	M 12 S (PR-2B)	Mini Z8	574736
	M 15 S (PR-2B)	Mini Z8	574738
	M 18 S (PR-2B)	Mini Z8	574740
	M 22 S (PR-2B)	Mini Z8	574742
Geberit Mapress Kupfer Gas	M 15		578312
	M 18		578314
	M 22		578316
	M 28		578318
	M 35		578390
	M 12 S (PR-2B)	Mini Z8	574736
	M 15 S (PR-2B)	Mini Z8	574738
	M 18 S (PR-2B)	Mini Z8	574740
	M 22 S (PR-2B)	Mini Z8	574742
	M 28 S (PR-2B)	Mini Z8	574744
Geberit Mepla	G 16		578444
	G 20		578446
	G 26		578448
	G 32		578450
	G 40		578452
	G 26		578448
Geberit Mepla Therm	G 20		578446
	G 26		578448
Geberit Volex	TH 16		578352
	TH 20		578358
	TH 26		578362

REMS pressing tongs Mini

REMS pressing rings

Accessories for REMS radial presses 22 kN

System	Pressing tongs/ pressing rings	Driven by adapter tongs	Art.-No.	System	Pressing tongs/ pressing rings	Driven by adapter tongs	Art.-No.
General Fittings 5T00	H 16		578400	General Fittings Trident Gas	H 16		578400
	H 20		578406		H 20		578406
	H 26		578410		H 26		578410
	H 32		578412		H 32		578412
	TH 16		578352		TH 16		578352
	TH 20		578358		TH 20		578358
	TH 26		578362		TH 26		578362
	TH 32		578364		TH 32		578364
	TH 40		578624		TH 16 S (PR-2B)		574782
	TH 16 S (PR-2B)	Mini Z8	574782		TH 20 S (PR-2B)	Mini Z8	574788
	TH 20 S (PR-2B)	Mini Z8	574788		TH 26 S (PR-2B)	Mini Z8	574794
	TH 26 S (PR-2B)	Mini Z8	574794		TH 32 S (PR-2B)	Mini Z8	574798
	TH 32 S (PR-2B)	Mini Z8	574798		U 16		578374
	U 16		578374		U 20		578378
	U 20		578378		U 32		578382
	U 32		578382		U 40		578386
U 40		578386					
General Fittings Ewoprex	H 16		578400	Giacomini	H 16		578400
	H 20		578406	Raccordi RM	H 20		578406
	H 26		578410	Giacomini	H 26		578410
	H 32		578412	H 32		578412	
	TH 16		578352	TH 16		578352	
	TH 20		578358	TH 20		578358	
	TH 26		578362	TH 26		578362	
	TH 32		578364	TH 32		578364	
	TH 40		578624	TH 40		578624	
	TH 16 S (PR-2B)	Mini Z8	574782	U 16		578374	
	TH 20 S (PR-2B)	Mini Z8	574788	U 20		578378	
	TH 26 S (PR-2B)	Mini Z8	574794	U 32		578382	
	TH 32 S (PR-2B)	Mini Z8	574798	U 40		578386	
	U 16		578374	Giacomini	H 16		578400
	U 20		578378	RM MULTIGAS	H 20		578406
	U 32		578382	H 26		578410	
U 40		578386	H 32		578412		
			TH 16		578352		
			TH 20		578358		
			TH 26		578362		
			TH 32		578364		
			U 16		578374		
			U 20		578378		
			U 32		578382		
			U 40		578386		
General Fittings Serie 5S00	B 16		578468	Giacomini	V 15		578328
	B 18		578470	Valvole Giacomini	V 18		578332
	B 20		578472	serie R850V	V 22		578334
	B 26		578474	V 28		578336	
	B 32		578476	V 35		578604	
	F 16		578456	V 15 S (PR-2B)	Mini Z8	574752	
	F 20		578460	V 18 S (PR-2B)	Mini Z8	574756	
	F 26		578462	V 22 S (PR-2B)	Mini Z8	574758	
	F 32		578464	V 28 S (PR-2B)	Mini Z8	574760	
	F 16 S (PR-2B)	Mini Z8	574728	V 35 S (PR-2B)	Mini Z8	574762	
	F 20 S (PR-2B)	Mini Z8	574730	SA 15		578514	
	F 24 S (PR-2B)	Mini Z8	574732	SA 18		578518	
	F 32 S (PR-2B)	Mini Z8	574734	SA 22		578520	
	H 16		578400	SA 28		578522	
	H 18		578404	M 15		578312	
	H 20		578406	M 18		578314	
	H 25		578408	M 22		578316	
	H 26		578410	M 28		578318	
	H 32		578412	M 35		578390	
	TH 16		578352	M 15 S (PR-2B)	Mini Z8	574738	
	TH 18		578356	M 18 S (PR-2B)	Mini Z8	574740	
	TH 20		578358	M 22 S (PR-2B)	Mini Z8	574742	
	TH 25		578360	M 28 S (PR-2B)	Mini Z8	574744	
	TH 26		578362	M 35 S (PR-2B)	Mini Z8	574746	
	TH 32		578364				
	TH 40		578624	Gotan Pipe	U 16		578374
	TH 16 S (PR-2B)	Mini Z8	574782	Systems	U 20		578378
	TH 20 S (PR-2B)	Mini Z8	574788	(Scandinavia)	U 25		578380
	TH 26 S (PR-2B)	Mini Z8	574794	Alu-Pres	U 32		578382
	TH 32 S (PR-2B)	Mini Z8	574798	U 40		578386	
	U 16		578374				
	U 18		578376	Grinnell G-PRESS	VUS ½" (OD 15,9 mm)		578566
U 20		578378	Copper Fittings	VUS ¾" (OD 22,2 mm)		578568	
U 25		578380		VUS 1" (OD 28,6 mm)		578570	
U 32		578382		VUS 1¼" (OD 34,9 mm)		578606	
U 40		578386	GS	TH 14		578348	
			Wärmesysteme	TH 16		578352	
			System TH	TH 20		578358	
				TH 26		578362	
				TH 32		578364	
				TH 40		578624	
				TH 16 S (PR-2B)	Mini Z8	574782	
				TH 20 S (PR-2B)	Mini Z8	574788	
				TH 26 S (PR-2B)	Mini Z8	574794	
				TH 32 S (PR-2B)	Mini Z8	574798	

Pressfitting systems for gas installations must only be pressed with REMS pressing tongs Mini/pressing rings which are highlighted in yellow.

Observe the national regulations. Read and observe the instructions for use and the installation instructions of the system provider/manufacturer.

- 1) Only pressing tongs from designation "108" (1st quarter of 2008), "208" (2nd quarter of 2008) etc. can be used. The designation is stamped on every pressing jaw.
- 2) For taking suitable pressing inserts.
- 3) Only pressing tongs from designation "117" (1st quarter of 2017), "217" (2nd quarter of 2017) etc. can be used. The designation is stamped on every pressing jaw.
- 4) For pipes of the EN technical standard. Observe the instructions for use of the system provider/manufacturer.
- 5) For pipes of the ASTM technical standard. Observe the instructions for use of the system provider/manufacturer.

The suitability of REMS pressing tools for pressfitting systems: Date 12.10.2022. For the updated situation regarding suitability status check our website:

www.rems.de > Downloads > Product catalogues, brochures > REMS Catalogue.

See page 180 for adapter tongs. Pressing tongs for additional pressfitting systems on request.

REMS pressing tongs Mini

REMS pressing rings

Accessories for REMS radial presses 22 kN

System	Pressing tongs / pressing rings	Driven by adapter tongs	Art.-No.
GS Wärmesysteme System V	V 15		578328
	V 18		578332
	V 22		578334
	V 28		578336
	V 35		578604
	V 15 S (PR-2B)	Mini Z8	574752
	V 18 S (PR-2B)	Mini Z8	574756
	V 22 S (PR-2B)	Mini Z8	574758
	V 28 S (PR-2B)	Mini Z8	574760
	V 35 S (PR-2B)	Mini Z8	574762
H			
HakaGerodur HAKASAN	TH 10		578342
	TH 11,6		578344
	TH 12		578346
	TH 14		578348
	TH 16		578352
	TH 17		578354
	TH 18		578356
	TH 20		578358
	TH 25		578360
	TH 26		578362
	TH 32		578364
	TH 40		578624
	TH 16 S (PR-2B)	Mini Z8	574782
	TH 20 S (PR-2B)	Mini Z8	574788
	TH 26 S (PR-2B)	Mini Z8	574794
	TH 32 S (PR-2B)	Mini Z8	574798
HASTINIK Hastinik/Hitpress	M 15		578312
	M 18		578314
	M 22		578316
	M 28		578318
	M 35		578390
	M 15 S (PR-2B)	Mini Z8	574738
	M 18 S (PR-2B)	Mini Z8	574740
	M 22 S (PR-2B)	Mini Z8	574742
	M 28 S (PR-2B)	Mini Z8	574744
	M 35 S (PR-2B)	Mini Z8	574746
heima24	TH 16		578352
	TH 20		578358
	TH 26		578362
	TH 32		578364
	TH 40		578624
	TH 16 S (PR-2B)	Mini Z8	574782
	TH 20 S (PR-2B)	Mini Z8	574788
	TH 26 S (PR-2B)	Mini Z8	574794
	TH 32 S (PR-2B)	Mini Z8	574798
	U 16		578374
U 20		578378	
U 25		578380	
U 32		578382	
HELIROMA Klimapress	U 16		578374
	U 18		578376
	U 20		578378
	U 25		578380
	U 32		578382
HELIROMA Romapress	Rfz 16		578492
	Rfz 20		578494
	Rfz 25		578496
	Rfz 32		578498
Henco	TH 14		578348
	TH 16		578352
	TH 18		578356
	TH 20		578358
	TH 26		578362
	HE 32		578370
Herotec tempusPRESS PLUS	H 16		578400
	H 20		578406
	H 25		578408
	H 32		578412
	Rfz 16		578492
	Rfz 20		578494
	Rfz 25		578496
	Rfz 32		578498
	TH 16		578352
	TH 20		578358
	TH 25		578360
	TH 32		578364
	TH 40		578624
TH 16 S (PR-2B)	Mini Z8	574782	
TH 20 S (PR-2B)	Mini Z8	574788	
TH 32 S (PR-2B)	Mini Z8	574798	
U 16		578374	
U 20		578378	
U 25		578380	
U 32		578382	
U 40		578386	
Herotec tempusPRESS PLUS PPSU	H 16		578400
	H 20		578406
	H 25		578408
	H 32		578412
	TH 16		578352
	TH 20		578358
	TH 25		578360
	TH 32		578364
	TH 40		578624
	TH 16 S (PR-2B)	Mini Z8	574782
	TH 20 S (PR-2B)	Mini Z8	574788
	TH 32 S (PR-2B)	Mini Z8	574798
	U 16		578374
U 20		578378	
U 25		578380	
U 32		578382	
U 40		578386	

System	Pressing tongs / pressing rings	Driven by adapter tongs	Art.-No.
HERZ PIPEFIX	TH 10		578342
	TH 16		578352
	TH 20		578358
	TH 26		578362
	TH 32		578364
	TH 40		578624
	TH 16 S (PR-2B)	Mini Z8	574782
	TH 20 S (PR-2B)	Mini Z8	574788
	TH 26 S (PR-2B)	Mini Z8	574794
	TH 32 S (PR-2B)	Mini Z8	574798
HIDRONIX MULTIGAS	TH 16		578352
	TH 20		578358
	TH 26		578362
HIDRONIX MULTIPIPE	TH 14		578348
	TH 16		578352
	TH 20		578358
	TH 26		578362
	TH 32		578364
	H 14		578398
	H 16		578400
	H 18		578404
	H 20		578406
	H 26		578410
	H 32		578412
	U 14		578372
	U 16		578374
	U 18		578376
	U 20		578378
	C 26		578392
U 32		578382	
HIDRONIX UNICO	TH 14		578348
	TH 16		578352
	TH 20		578358
	TH 26		578362
	TH 32		578364
	H 14		578398
	H 16		578400
	H 18		578404
	H 20		578406
	H 26		578410
H 32		578412	
U 14		578372	
U 16		578374	
U 18		578376	
U 20		578378	
C 26		578392	
U 32		578382	
HITEC Sistema Multistrato	TH 14		578348
	TH 16		578352
	TH 18		578356
	TH 20		578358
	TH 26		578362
	TH 32		578364
	TH 40		578624
	TH 16 S (PR-2B)	Mini Z8	574782
	TH 20 S (PR-2B)	Mini Z8	574788
	TH 26 S (PR-2B)	Mini Z8	574794
TH 32 S (PR-2B)	Mini Z8	574798	
HITHERM-ISOTUBI NUMEPRESS	M 15		578312
	M 18		578314
	M 22		578316
	M 28		578318
	M 35		578390
	M 15 S (PR-2B)	Mini Z8	574738
	M 18 S (PR-2B)	Mini Z8	574740
	M 22 S (PR-2B)	Mini Z8	574742
	M 28 S (PR-2B)	Mini Z8	574744
	M 35 S (PR-2B)	Mini Z8	574746
HITHERM-ISOTUBI HTpress	M 15		578312
	M 18		578314
	M 22		578316
	M 28		578318
	M 35		578390
	M 15 S (PR-2B)	Mini Z8	574738
	M 18 S (PR-2B)	Mini Z8	574740
	M 22 S (PR-2B)	Mini Z8	574742
	M 28 S (PR-2B)	Mini Z8	574744
	M 35 S (PR-2B)	Mini Z8	574746
HITHERM-ISOTUBI HTfire	M 15		578312
	M 18		578314
	M 22		578316
	M 28		578318
	M 35		578390
	M 15 S (PR-2B)	Mini Z8	574738
	M 18 S (PR-2B)	Mini Z8	574740
	M 22 S (PR-2B)	Mini Z8	574742
	M 28 S (PR-2B)	Mini Z8	574744
	M 35 S (PR-2B)	Mini Z8	574746
HITHERM-ISOTUBI HTair	M 15		578312
	M 18		578314
	M 22		578316
	M 28		578318
	M 35		578390
	M 15 S (PR-2B)	Mini Z8	574738
	M 18 S (PR-2B)	Mini Z8	574740
	M 22 S (PR-2B)	Mini Z8	574742
	M 28 S (PR-2B)	Mini Z8	574744
	M 35 S (PR-2B)	Mini Z8	574746
Hopewell press fit system	M 15		578312
	M 18		578314
	M 22		578316
	M 28		578318
	M 35		578390
	M 35 S (PR-2B)	Mini Z8	574746

REMS pressing tongs Mini REMS pressing rings

Accessories for REMS radial presses 22 kN

System	Pressing tongs/ pressing rings	Driven by adapter tongs	Art.-No.
hp praski BAVARIA-press	TH 10		578342
	TH 12		578346
	TH 14		578348
	TH 16		578352
	TH 17		578354
	TH 20		578358
	TH 25		578360
	TH 26		578362
	TH 32		578364
	TH 40		578624
	TH 16 S (PR-2B)	Mini Z8	574782
	TH 20 S (PR-2B)	Mini Z8	574788
	TH 26 S (PR-2B)	Mini Z8	574794
	TH 32 S (PR-2B)	Mini Z8	574798
ICMA Sempiter	H 16		578400
	H 20		578406
	H 25		578408
	H 26		578410
	H 32		578412
	TH 16		578352
	TH 20		578358
	TH 25		578360
	TH 26		578362
	TH 32		578364
	TH 40		578624
	TH 16 S (PR-2B)	Mini Z8	574782
	TH 20 S (PR-2B)	Mini Z8	574788
	TH 26 S (PR-2B)	Mini Z8	574794
	TH 32 S (PR-2B)	Mini Z8	574798
	U 16		578374
	U 20		578378
	U 25		578380
	C 26		578392
	U 32		578382
U 40		578386	
ICMA Sempigas	TH 16		578352
	TH 20		578358
	TH 25		578360
	TH 26		578362
	TH 32		578364
	TH 16 S (PR-2B)	Mini Z8	574782
	TH 20 S (PR-2B)	Mini Z8	574788
TH 26 S (PR-2B)	Mini Z8	574794	
TH 32 S (PR-2B)	Mini Z8	574798	
Idrosanitaria Bonomi Homegas	TH 16		578352
	TH 20		578358
	TH 26		578362
	TH 16 S (PR-2B)	Mini Z8	574782
	TH 20 S (PR-2B)	Mini Z8	574788
TH 26 S (PR-2B)	Mini Z8	574794	
Idrosanitaria Bonomi Idropress	TH 16		578352
	TH 18		578356
	TH 20		578358
	TH 26		578362
	TH 32		578364
	TH 40		578624
	TH 16 S (PR-2B)	Mini Z8	574782
	TH 20 S (PR-2B)	Mini Z8	574788
	TH 26 S (PR-2B)	Mini Z8	574794
	TH 32 S (PR-2B)	Mini Z8	574798
IDROSISTEMI Ta-Press	TH 16		578352
	TH 20		578358
	TH 26		578362
	TH 32		578364
	TH 40		578624
	TH 16 S (PR-2B)	Mini Z8	574782
	TH 20 S (PR-2B)	Mini Z8	574788
	TH 26 S (PR-2B)	Mini Z8	574794
	TH 32 S (PR-2B)	Mini Z8	574798
	F 16		578456
	F 20		578460
	F 26		578462
	F 32		578464
	F 16 S (PR-2B)	Mini Z8	574728
	F 20 S (PR-2B)	Mini Z8	574730
	F 26 S (PR-2B)	Mini Z8	574732
	F 32 S (PR-2B)	Mini Z8	574734
	Fz 40		578478
	H 16		578400
	H 20		578406
	H 26		578410
	H 32		578412
	U 16		578374
	U 20		578378
	C 26		578392
	U 32		578382
	U 40		578386
	B 16		578468
	B 20		578472
	B 26		578474
	B 32		578476

System	Pressing tongs/ pressing rings	Driven by adapter tongs	Art.-No.
IDROTRADE Storm Multipinza	H 16		578400
	H 20		578406
	H 26		578410
	H 32		578412
	TH 16		578352
	TH 20		578358
	TH 26		578362
	TH 32		578364
	THL 32		578368
	TH 40		578624
	TH 16 S (PR-2B)	Mini Z8	574782
	TH 20 S (PR-2B)	Mini Z8	574788
	TH 26 S (PR-2B)	Mini Z8	574794
	TH 32 S (PR-2B)	Mini Z8	574798
IDROTRADE StormPRES ¹⁾	U 16		578374
	U 20		578378
	M 15		578312
	M 18		578314
	M 22		578316
	M 28		578318
	M 35		578390
	M 15 S (PR-2B)	Mini Z8	574738
	M 18 S (PR-2B)	Mini Z8	574740
	M 22 S (PR-2B)	Mini Z8	574742
IDROTRADE StormSTEEL ¹⁾	M 28 S (PR-2B)	Mini Z8	574744
	M 35 S (PR-2B)	Mini Z8	574746
	M 12		578310
	M 15		578312
	M 18		578314
	M 22		578316
	M 28		578318
	M 35		578390
	M 12 S (PR-2B)	Mini Z8	574736
	M 15 S (PR-2B)	Mini Z8	574738
ILTA INOX/CHIBRO Pressfitting Cuni	M 18 S (PR-2B)	Mini Z8	574740
	M 22 S (PR-2B)	Mini Z8	574742
	M 28 S (PR-2B)	Mini Z8	574744
	M 35 S (PR-2B)	Mini Z8	574746
	M 15		578312
	M 18		578314
	M 22		578316
	M 28		578318
	M 35		578390
	M 15 S (PR-2B)	Mini Z8	574738
ILTA INOX/CHIBRO Pressfitting inox	M 18 S (PR-2B)	Mini Z8	574740
	M 22 S (PR-2B)	Mini Z8	574742
	M 28 S (PR-2B)	Mini Z8	574744
	M 35 S (PR-2B)	Mini Z8	574746
	M 15		578312
	M 18		578314
	M 22		578316
	M 28		578318
	M 35		578390
	M 15 S (PR-2B)	Mini Z8	574738
Instantor Copper Press Imperial	M 18 S (PR-2B)	Mini Z8	574740
	M 22 S (PR-2B)	Mini Z8	574742
	M 28 S (PR-2B)	Mini Z8	574744
	M 35 S (PR-2B)	Mini Z8	574746
Instantor Copper Press Metric	VI ½" (OD 14,7 mm)		578716
	VI ¾" (OD 21,0 mm)		578718
	VI 1" (OD 27,4 mm)		578720
Instantor Press System	M 15		578312
	M 22		578316
	M 28		578318
	M 15 S (PR-2B)	Mini Z8	574738
	M 22 S (PR-2B)	Mini Z8	574742
	M 28 S (PR-2B)	Mini Z8	574744
IPA IPANA Press	M 35 S (PR-2B)	Mini Z8	574746
	TH 16		578352
	TH 20		578358
	TH 26		578362
	TH 32		578364
	TH 16 S (PR-2B)	Mini Z8	574782
	TH 20 S (PR-2B)	Mini Z8	574788
	TH 26 S (PR-2B)	Mini Z8	574794
	TH 32 S (PR-2B)	Mini Z8	574798
	TH 10		578342
TH 11,6		578344	
TH 12		578346	
TH 14		578348	
TH 15		578350	
TH 16		578352	
TH 17		578354	
TH 18		578356	
TH 20		578358	
TH 22		578588	
TH 25		578360	
TH 26		578362	
TH 28		578590	
TH 32		578364	
TH 40		578624	
TH 16 S (PR-2B)	Mini Z8	574782	
TH 20 S (PR-2B)	Mini Z8	574788	
TH 26 S (PR-2B)	Mini Z8	574794	
TH 32 S (PR-2B)	Mini Z8	574798	

Pressfitting systems for gas installations must only be pressed with REMS pressing tongs Mini/pressing rings which are highlighted in yellow.

Observe the national regulations. Read and observe the instructions for use and the installation instructions of the system provider/manufacturer.

- 1) Only pressing tongs from designation "108" (1st quarter of 2008), "208" (2nd quarter of 2008) etc. can be used. The designation is stamped on every pressing jaw.
- 2) For taking suitable pressing inserts.
- 3) Only pressing tongs from designation "117" (1st quarter of 2017), "217" (2nd quarter of 2017) etc. can be used. The designation is stamped on every pressing jaw.
- 4) For pipes of the EN technical standard. Observe the instructions for use of the system provider/manufacturer.
- 5) For pipes of the ASTM technical standard. Observe the instructions for use of the system provider/manufacturer.

The suitability of REMS pressing tools for pressfitting systems: Date 12.10.2022. For the updated situation regarding suitability status check our website: www.rems.de > Downloads > Product catalogues, brochures > REMS Catalogue.

See page 180 for adapter tongs. Pressing tongs for additional pressfitting systems on request.

REMS pressing tongs Mini REMS pressing rings

Accessories for REMS radial presses 22 kN

System	Pressing tongs / pressing rings	Driven by adapter tongs	Art.-No.	
IPA THu	TH 16		578352	
IPANA Press	TH 20		578358	
	TH 26		578362	
	TH 32		578364	
	TH 40		578624	
	TH 16 S (PR-2B)	Mini Z8	574782	
	TH 20 S (PR-2B)	Mini Z8	574788	
	TH 26 S (PR-2B)	Mini Z8	574794	
	TH 32 S (PR-2B)	Mini Z8	574798	
IPALPEX (Industrie du Plastique et Accessoires)	TH 14		578348	
	TH 16		578352	
	TH 18		578356	
	TH 20		578358	
	TH 26		578362	
	THL 32		578368	
	TH 40		578624	
IPLEX	K16/P18		578592	
PIPELINES AUSTRALIA Iplex Pro-fit				
IPLEX	K16/P18		578592	
PIPELINES	K/20		578594	
AUSTRALIA	K/25		578596	
Iplex K1	K32		578598	
(Gas)	K1/40		578600	
IPLEX	K16/P18		578592	
PIPELINES	K/20		578594	
AUSTRALIA	K/25		578596	
Iplex K2				
ISOTUBI	M 15		578312	
NUMEPRESS	M 18		578314	
	M 22		578316	
	M 28		578318	
	M 35		578390	
	M 15 S (PR-2B)	Mini Z8	574738	
	M 18 S (PR-2B)	Mini Z8	574740	
	M 22 S (PR-2B)	Mini Z8	574742	
	M 28 S (PR-2B)	Mini Z8	574744	
	M 35 S (PR-2B)	Mini Z8	574746	
	IVAR	B 20		578472
	ALPEX-GAS	B 26		578474
B 32			578476	
IVAR	TH 16		578352	
MULTI PRESS	TH 20		578358	
GAS ITALIA	TH 26		578362	
	H 16		578400	
	H 20		578406	
	H 26		578410	
	U 16		578374	
	U 20		578378	
IVAR	TH 16		578352	
Multi Press MP	TH 18		578356	
	TH 20		578358	
	TH 25		578360	
	TH 26		578362	
	TH 32		578364	
	TH 40		578624	
	TH 16 S (PR-2B)	Mini Z8	574782	
	TH 20 S (PR-2B)	Mini Z8	574788	
	TH 26 S (PR-2B)	Mini Z8	574794	
	TH 32 S (PR-2B)	Mini Z8	574798	
	F 16		578456	
	F 18		578458	
	F 20		578460	
	F 26		578462	
	F 32		578464	
	Fz 40		578478	
	F 16 S (PR-2B)	Mini Z8	574728	
	F 20 S (PR-2B)	Mini Z8	574730	
	F 26 S (PR-2B)	Mini Z8	574732	
	F 32 S (PR-2B)	Mini Z8	574734	
	H 16		578400	
	H 18		578404	
	H 20		578406	
	H 25		578408	
	H 26		578410	
	H 32		578412	
	U 16		578374	
	U 18		578376	
	U 20		578378	
	U 25		578380	
	C 26		578392	
	U 32		578382	
	U 40		578386	
	B 16		578468	
	B 18		578470	
B 20		578472		
B 26		578474		
B 32		578476		

System	Pressing tongs / pressing rings	Driven by adapter tongs	Art.-No.	
IVAR Multi Press Leak (MPL)	TH 16		578352	
	TH 20		578358	
	TH 26		578362	
	TH 32		578364	
	TH 16 S (PR-2B)	Mini Z8	574782	
	TH 20 S (PR-2B)	Mini Z8	574788	
	TH 26 S (PR-2B)	Mini Z8	574794	
	TH 32 S (PR-2B)	Mini Z8	574798	
	F 16		578456	
	F 20		578460	
	F 26		578462	
	F 32		578464	
	F 16 S (PR-2B)	Mini Z8	574728	
	F 20 S (PR-2B)	Mini Z8	574730	
	F 26 S (PR-2B)	Mini Z8	574732	
	F 32 S (PR-2B)	Mini Z8	574734	
	H 16		578400	
	H 20		578406	
	H 25		578408	
	H 26		578410	
	H 32		578412	
	U 16		578374	
	U 20		578378	
	U 25		578380	
	C 26		578392	
	U 32		578382	
	B 16		578468	
	B 20		578472	
	B 26		578474	
	B 32		578476	
	IVAR	TH 16		578352
	Plastic Multi Press PMP	TH 20		578358
		TH 25		578360
TH 26			578362	
TH 32			578364	
TH 16 S (PR-2B)		Mini Z8	574782	
TH 20 S (PR-2B)		Mini Z8	574788	
TH 26 S (PR-2B)		Mini Z8	574794	
TH 32 S (PR-2B)		Mini Z8	574798	
F 16			578456	
F 20			578460	
F 26			578462	
F 32			578464	
F 16 S (PR-2B)		Mini Z8	574728	
F 20 S (PR-2B)		Mini Z8	574730	
F 26 S (PR-2B)		Mini Z8	574732	
F 32 S (PR-2B)		Mini Z8	574734	
H 16			578400	
H 20			578406	
H 26			578410	
H 32			578412	
U 16			578374	
U 20			578378	
C 26			578392	
U 32			578382	
B 16			578468	
B 20			578472	
B 26			578474	
B 32			578476	
IVAR		TH 16		578352
Plastic Multi Press Leak (PMPL)		TH 20		578358
		TH 26		578362
		TH 32		578364
		TH 16 S (PR-2B)	Mini Z8	574782
		TH 20 S (PR-2B)	Mini Z8	574788
		TH 26 S (PR-2B)	Mini Z8	574794
	TH 32 S (PR-2B)	Mini Z8	574798	
	F 16		578456	
	F 20		578460	
	F 26		578462	
	F 32		578464	
	F 16 S (PR-2B)	Mini Z8	574728	
	F 20 S (PR-2B)	Mini Z8	574730	
	F 26 S (PR-2B)	Mini Z8	574732	
	F 32 S (PR-2B)	Mini Z8	574734	
	H 16		578400	
	H 20		578406	
	H 26		578410	
	H 32		578412	
	U 16		578374	
	U 20		578378	
	C 26		578392	
	U 32		578382	
	B 16		578468	
	B 20		578472	
	B 26		578474	
	B 32		578476	
	IVT Edelstahl- Presssystem	M 15		578312
		M 18		578314
		M 22		578316
		M 28		578318
		M 35		578390
		M 15 S (PR-2B)	Mini Z8	574738
		M 18 S (PR-2B)	Mini Z8	574740
		M 22 S (PR-2B)	Mini Z8	574742
	M 28 S (PR-2B)	Mini Z8	574744	
	M 35 S (PR-2B)	Mini Z8	574746	

REMS pressing tongs Mini REMS pressing rings

Accessories for REMS radial presses 22 kN

System	Pressing tongs/ pressing rings	Driven by adapter tongs	Art.-No.
IVT PRIPRESS	TH 16		578352
	TH 20		578358
	TH 26		578362
	TH 32		578364
	TH 40		578624
	TH 16 S (PR-2B)	Mini Z8	574782
	TH 20 S (PR-2B)	Mini Z8	574788
	TH 26 S (PR-2B)	Mini Z8	574794
	TH 32 S (PR-2B)	Mini Z8	574798
J			
Jäger - Aquatec Aquapress H	H 14		578398
	H 16		578400
	H 17		578402
	H 18		578404
	H 20		578406
	H 26		578410
	H 32		578412
	U 40		578386
Jäger - Aquatec C-Stahl Press Typ M	M 15		578312
	M 18		578314
	M 22		578316
	M 28		578318
	M 35		578390
	M 15 S (PR-2B)	Mini Z8	574738
	M 18 S (PR-2B)	Mini Z8	574740
	M 22 S (PR-2B)	Mini Z8	574742
	M 28 S (PR-2B)	Mini Z8	574744
	M 35 S (PR-2B)	Mini Z8	574746
Jäger - Aquatec Edelstahl Press Typ M	M 15		578312
	M 18		578314
	M 22		578316
	M 28		578318
	M 35		578390
	M 15 S (PR-2B)	Mini Z8	574738
	M 18 S (PR-2B)	Mini Z8	574740
	M 22 S (PR-2B)	Mini Z8	574742
	M 28 S (PR-2B)	Mini Z8	574744
	M 35 S (PR-2B)	Mini Z8	574746
Jäger - Aquatec Kupfer Press Typ V	V 15		578328
	V 18		578332
	V 22		578334
	V 28		578336
	V 35		578404
	V 15 S (PR-2B)	Mini Z8	574752
	V 18 S (PR-2B)	Mini Z8	574756
	V 22 S (PR-2B)	Mini Z8	574758
	V 28 S (PR-2B)	Mini Z8	574760
	V 35 S (PR-2B)	Mini Z8	574762
Jansen AG JANSEN COMISA	TH 14		578348
	TH 16		578352
	TH 20		578358
	TH 26		578362
	TH 32		578364
	TH 40		578624
	TH 16 S (PR-2B)	Mini Z8	574782
	TH 20 S (PR-2B)	Mini Z8	574788
	TH 26 S (PR-2B)	Mini Z8	574794
	TH 32 S (PR-2B)	Mini Z8	574798
Jaraflex- Presssystem	TH 14		578348
	TH 16		578352
	TH 17		578354
	TH 18		578356
	TH 20		578358
	TH 25		578360
	TH 26		578362
	TH 32		578364
	TH 40		578624
	TH 16 S (PR-2B)	Mini Z8	574782
	TH 20 S (PR-2B)	Mini Z8	574788
	TH 26 S (PR-2B)	Mini Z8	574794
	TH 32 S (PR-2B)	Mini Z8	574798
JUNGWOO JWPress	VUS ½" (OD 15,9 mm)		578566
	VUS ¾" (OD 22,2 mm)		578568
	VUS 1" (OD 28,6 mm)		578570
	VUS 1¼" (OD 34,9 mm)		578606
K			
KAN KAN-therm Press	U 16		578374
	U 20		578378
	U 25		578380
	C 26		578392
	U 32		578382
	U 40		578386

System	Pressing tongs/ pressing rings	Driven by adapter tongs	Art.-No.
KAN KAN-therm Press LBP	TH 14		578348
	TH 16		578352
	TH 20		578358
	TH 25		578360
	TH 26		578362
	TH 32		578364
	TH 40		578624
	TH 16 S (PR-2B)	Mini Z8	574782
	TH 20 S (PR-2B)	Mini Z8	574788
	TH 26 S (PR-2B)	Mini Z8	574794
	TH 32 S (PR-2B)	Mini Z8	574798
	U 14		578372
	U 16		578374
	U 20		578378
	U 25		578380
	C 26		578392
	U 32		578382
U 40		578386	
KAN KAN-therm Inox	M 12		578310
	M 15		578312
	M 18 ¹⁾		578314
	M 22		578316
	M 28 ¹⁾		578318
	M 35		578390
	M 12 S (PR-2B)	Mini Z8	574736
	M 15 S (PR-2B)	Mini Z8	574738
	M 18 S (PR-2B)	Mini Z8	574740
	M 22 S (PR-2B)	Mini Z8	574742
	M 28 S (PR-2B)	Mini Z8	574744
	M 35 S (PR-2B)	Mini Z8	574746
KAN KAN-therm Steel	M 12		578310
	M 15		578312
	M 18 ¹⁾		578314
	M 22		578316
	M 28 ¹⁾		578318
	M 35		578390
	M 12 S (PR-2B)	Mini Z8	574736
	M 15 S (PR-2B)	Mini Z8	574738
	M 18 S (PR-2B)	Mini Z8	574740
	M 22 S (PR-2B)	Mini Z8	574742
	M 28 S (PR-2B)	Mini Z8	574744
	M 35 S (PR-2B)	Mini Z8	574746
KAN KAN-therm UltraPRESS	TH 14		578348
	TH 16		578352
	TH 20		578358
	TH 25		578360
	TH 26		578362
	TH 32		578364
	TH 40		578624
	TH 16 S (PR-2B)	Mini Z8	574782
	TH 20 S (PR-2B)	Mini Z8	574788
	TH 26 S (PR-2B)	Mini Z8	574794
	TH 32 S (PR-2B)	Mini Z8	574798
	U 14		578372
	U 16		578374
	U 20		578378
	U 25		578380
	C 26		578392
	U 32		578382
U 40		578386	
KE KELIT COPPERFIX Kupfer	M 15		578312
	M 18		578314
	M 22		578316
	M 28		578318
	M 35		578390
	M 15 S (PR-2B)	Mini Z8	574738
	M 18 S (PR-2B)	Mini Z8	574740
	M 22 S (PR-2B)	Mini Z8	574742
	M 28 S (PR-2B)	Mini Z8	574744
	M 35 S (PR-2B)	Mini Z8	574746
KE KELIT KELOX	U 16		578374
	U 18		578376
	U 20		578378
	U 25		578380
	U 32		578382
	U 40		578386
	KE KELIT KELOX-PPSU-W	U 16	
U 18			578376
U 20			578378
U 25			578380
U 32			578382
U 40			578386
KE KELIT KELOX-ULTRAX	U 16		578374
	U 18		578376
	U 20		578378
	U 25		578380
	U 32		578382
	U 40		578386
KE KELIT KELOX-ULTRAX-W	U 16		578374
	U 18		578376
	U 20		578378
	U 25		578380
	U 32		578382
	U 40		578386

Pressfitting systems for gas installations must only be pressed with REMS pressing tongs Mini/pressing rings which are highlighted in yellow.

Observe the national regulations. Read and observe the instructions for use and the installation instructions of the system provider/manufacturer.

- 1) Only pressing tongs from designation "108" (1st quarter of 2008), "208" (2nd quarter of 2008) etc. can be used. The designation is stamped on every pressing jaw.
- 2) For taking suitable pressing inserts.
- 3) Only pressing tongs from designation "117" (1st quarter of 2017), "217" (2nd quarter of 2017) etc. can be used. The designation is stamped on every pressing jaw.
- 4) For pipes of the EN technical standard. Observe the instructions for use of the system provider/manufacturer.
- 5) For pipes of the ASTM technical standard. Observe the instructions for use of the system provider/manufacturer.

The suitability of REMS pressing tools for pressfitting systems: Date 12.10.2022. For the updated situation regarding suitability status check our website:

www.rems.de > Downloads > Product catalogues, brochures > REMS Catalogue.

See page 180 for adapter tongs. Pressing tongs for additional pressfitting systems on request.

REMS pressing tongs Mini

REMS pressing rings

Accessories for REMS radial presses 22 kN

System	Pressing tongs / pressing rings	Driven by adapter tongs	Art.-No.
KE KELIT KELO-WINDOW-U	U 16		578374
	U 18		578376
	U 20		578378
	U 25		578380
	U 32		578382
KE KELIT KELOX-WINDOW-W	U 16		578374
	U 18		578376
	U 20		578378
	U 25		578380
	U 32		578382
KE KELIT steelFIX C-Stahl	M 15		578312
	M 18		578314
	M 22		578316
	M 28		578318
	M 35		578390
	M 15 S (PR-2B)	Mini Z8	574738
	M 18 S (PR-2B)	Mini Z8	574740
	M 22 S (PR-2B)	Mini Z8	574742
	M 28 S (PR-2B)	Mini Z8	574744
	M 35 S (PR-2B)	Mini Z8	574746
	KE KELIT steelFIX Edelstahl	M 15	
M 18			578314
M 22			578316
M 28			578318
M 35			578390
M 15 S (PR-2B)		Mini Z8	574738
M 18 S (PR-2B)		Mini Z8	574740
M 22 S (PR-2B)		Mini Z8	574742
M 28 S (PR-2B)		Mini Z8	574744
M 35 S (PR-2B)		Mini Z8	574746
KEMBLA KemPress (AUS)		VAU 15 (OD 12,7 mm)	
	VAU 20 (OD 19,1 mm)		578632
	VAU 25 (OD 25,4 mm)		578634
	VAU 32 (OD 31,8 mm)		578636
KEMBLA KemPress Gas (AUS)	VAU 15 (OD 12,7 mm)		578630
	VAU 20 (OD 19,1 mm)		578632
	VAU 25 (OD 25,4 mm)		578634
	VAU 32 (OD 31,8 mm)		578636
KISAN Kisan KD	KI 16		578524
	KI 20		578526
	KI 25		578528
	TH 16		578352
	TH 20		578358
	TH 25		578360
	TH 16 S (PR-2B)	Mini Z8	574782
	TH 20 S (PR-2B)	Mini Z8	574788
KISAN Kisan WL	KI 16		578524
	KI 20		578526
	KI 25		578528
	KI 32		578530
	TH 16		578352
	TH 20		578358
	TH 25		578360
	TH 32		578364
KISAN Kisan WM	KI 16		578524
	KI 20		578526
	KI 25		578528
	KI 32		578530
KISAN Kisan WR	U 20		578378
	U 25		578380
	U 32		578382
	U 40		578386
	TH 20		578358
	TH 25		578360
	TH 32		578364
	TH 40		578624
	TH 20 S (PR-2B)	Mini Z8	574788
	TH 32 S (PR-2B)	Mini Z8	574798
KISAN Kistal C	M 15		578312
	M 18		578314
	M 22		578316
	M 28		578318
	M 35		578390
	M 15 S (PR-2B)	Mini Z8	574738
	M 18 S (PR-2B)	Mini Z8	574740
	M 22 S (PR-2B)	Mini Z8	574742
	M 28 S (PR-2B)	Mini Z8	574744
	M 35 S (PR-2B)	Mini Z8	574746
KISAN Kistal Inox	M 15		578312
	M 18		578314
	M 22		578316
	M 28		578318
	M 35		578390
	M 15 S (PR-2B)	Mini Z8	574738
	M 18 S (PR-2B)	Mini Z8	574740
	M 22 S (PR-2B)	Mini Z8	574742
	M 28 S (PR-2B)	Mini Z8	574744
	M 35 S (PR-2B)	Mini Z8	574746
LEGEND-PRESS press fitting system	VUS ½" (OD 15,9 mm)		578566
	VUS ¾" (OD 22,2 mm)		578568
	VUS 1" (OD 28,6 mm)		578570
	VUS 1¼" (OD 34,9 mm)		578606

L

System	Pressing tongs / pressing rings	Driven by adapter tongs	Art.-No.	
LK Systems LK >B-Press	V 12		578324	
	V 15		578328	
	V 18		578332	
	V 22		578334	
	V 28		578336	
	V 35		578604	
	V 12 S (PR-2B)	Mini Z8	574748	
	V 15 S (PR-2B)	Mini Z8	574752	
	V 18 S (PR-2B)	Mini Z8	574756	
	V 22 S (PR-2B)	Mini Z8	574758	
	V 28 S (PR-2B)	Mini Z8	574760	
	V 35 S (PR-2B)	Mini Z8	574762	
	LK Systems LK >B-Press Eltörzinkat	V 12		578324
V 15			578328	
V 18			578332	
V 22			578334	
V 28			578336	
V 35			578604	
V 12 S (PR-2B)		Mini Z8	574748	
V 15 S (PR-2B)		Mini Z8	574752	
V 18 S (PR-2B)		Mini Z8	574756	
V 22 S (PR-2B)		Mini Z8	574758	
V 28 S (PR-2B)		Mini Z8	574760	
V 35 S (PR-2B)		Mini Z8	574762	
LK Systems LK >B-Press Gas		V 15		578328
	V 18		578332	
	V 22		578334	
	V 28		578336	
	V 35		578604	
	V 15 S (PR-2B)	Mini Z8	574752	
	V 18 S (PR-2B)	Mini Z8	574756	
	V 22 S (PR-2B)	Mini Z8	574758	
	V 28 S (PR-2B)	Mini Z8	574760	
	V 35 S (PR-2B)	Mini Z8	574762	
	LK Systems LK Universal	TH 16		578352
		TH 20		578358
		TH 25		578360
TH 32			578364	
TH 40			578624	
LVI-DAHL Altech-Alupez	U 16		578374	
	U 20		578378	
	U 25		578380	
MAINCOR MAINPRESS	U 16		578374	
	U 20		578378	
	U 25		578380	
	U 32		578382	
MAINCOR MAINFLOR	U 16		578374	
	U 20		578378	
Mair Heiztechnik M-Press	H 11,5		578394	
	TH 16		578352	
	TH 20		578358	
	TH 26		578362	
	TH 32		578364	
	TH 40		578624	
	TH 16 S (PR-2B)	Mini Z8	574782	
	TH 20 S (PR-2B)	Mini Z8	574788	
Ma.s.ter System PRESSMASTER	TH 14		578348	
	TH 16		578352	
	TH 18		578356	
	TH 20		578358	
	TH 25		578360	
	TH 26		578362	
	TH 32		578364	
	TH 40		578624	
	TH 16 S (PR-2B)	Mini Z8	574782	
	TH 20 S (PR-2B)	Mini Z8	574788	
Meier Tobler Metalplast - Stramax Serie MM	TH 26 S (PR-2B)	Mini Z8	574794	
	TH 32 S (PR-2B)	Mini Z8	574798	
	H 14		578398	
	H 16		578400	
	H 18		578404	
	H 20		578406	
	H 26		578410	
	H 32		578412	
	U 14		578372	
	U 16		578374	
	U 18		578376	
	U 20		578378	
	U 25		578380	
U 32		578382		
U 40		578386		
METALGRUP Permatubo	H 16		578400	
	H 20		578406	
	H 25		578408	
	H 32		578412	
	RfZ 16		578492	
	RfZ 20		578494	
	RfZ 25		578496	
	RfZ 32		578498	
	TH 16		578352	
	TH 20		578358	
	TH 25		578360	
	TH 32		578364	
	TH 40		578624	
TH 16 S (PR-2B)	Mini Z8	574782		
TH 20 S (PR-2B)	Mini Z8	574788		
TH 32 S (PR-2B)	Mini Z8	574798		
U 16		578374		
U 20		578378		
U 25		578380		
U 32		578382		
U 40		578386		

REMS pressing tongs Mini

REMS pressing rings

Accessories for REMS radial presses 22 kN

System	Pressing tongs / pressing rings	Driven by adapter tongs	Art.-No.
METALGRUP PexGrup	RFz 16		578492
	RFz 20		578494
	RFz 25		578496
	RFz 32		578498
METALGRUP MultiGrup	U 16		578374
	U 18		578376
	U 20		578378
	U 25		578380
	U 32		578382
Mueller Industries Streamline PRS	VUS ½" (OD 15,9 mm)		578566
	VUS ¾" (OD 22,2 mm)		578568
	VUS 1" (OD 28,6 mm)		578570
	VUS 1¼" (OD 34,9 mm)		578606
MULTITHERM PRESSSYSTEM	TH 16		578352
	TH 20		578358
	TH 26		578362
	TH 32		578364
	TH 40		578624
	TH 16 S (PR-2B)	Mini Z8	574782
	TH 20 S (PR-2B)	Mini Z8	574788
	TH 26 S (PR-2B)	Mini Z8	574794
	TH 32 S (PR-2B)	Mini Z8	574798
Multicap Industrial AIS PEX	RFz 16		578492
	RFz 20		578494
	RFz 25		578496
	RFz 32		578498
	U 16		578374
	U 20		578378
	U 25		578380
Multicap Industrial AIS XPRT	U 32		578382
	H 16		578400
	H 20		578406
	H 25		578408
	H 26		578410
	H 32		578412
	RFz 16		578492
	RFz 20		578494
	RFz 25		578496
	RFz 32		578498
	TH 16		578352
	TH 20		578358
	TH 25		578360
	TH 26		578362
	TH 32		578364
	TH 40		578624
	TH 16 S (PR-2B)	Mini Z8	574782
	TH 20 S (PR-2B)	Mini Z8	574788
	TH 26 S (PR-2B)	Mini Z8	574794
	TH 32 S (PR-2B)	Mini Z8	574798
	U 16		578374
	U 20		578378
	U 25		578380
	U 32		578382
	U 40		578386
	Multicap Industrial multitubo systems MC	U 16	
U 18			578376
U 20			578378
U 25			578380
U 32			578382
U 40			578386
Multicap Industrial multitubo systems MM	H 16		578400
	H 20		578406
	H 25		578408
	H 26		578410
	H 32		578412
	RFz 16		578492
	RFz 20		578494
	RFz 25		578496
	RFz 32		578498
	TH 16		578352
	TH 20		578358
	TH 25		578360
	TH 26		578362
	TH 32		578364
	TH 40		578624
	TH 16 S (PR-2B)	Mini Z8	574782
	TH 20 S (PR-2B)	Mini Z8	574788
	TH 26 S (PR-2B)	Mini Z8	574794
	TH 32 S (PR-2B)	Mini Z8	574798
	U 16		578374
U 20		578378	
U 25		578380	
U 32		578382	
U 40		578386	

N

NEUTHERM MEKUPRESS-HT	H 16		578400
	H 20		578406
	H 26		578410
	H 32		578412

System	Pressing tongs / pressing rings	Driven by adapter tongs	Art.-No.	
NIBCO (USA) Press System Copper	VUS ½" (OD 15,9 mm)		578566	
	VUS ¾" (OD 22,2 mm)		578568	
	VUS 1" (OD 28,6 mm)		578570	
	VUS 1¼" (OD 34,9 mm)		578606	
NICOLL FLUXO	TH 16		578352	
	TH 20		578358	
	TH 25		578360	
	TH 26		578362	
	TH 32		578364	
	TH 40		578624	
	TH 16 S (PR-2B)	Mini Z8	574782	
	TH 20 S (PR-2B)	Mini Z8	574788	
	TH 26 S (PR-2B)	Mini Z8	574794	
	TH 32 S (PR-2B)	Mini Z8	574798	
NUPI Industrie Italiane Multinupi	B 16		578468	
	B 18		578470	
	B 20		578472	
	B 26		578474	
	B 32		578476	
	F 16		578456	
	F 18		578458	
	F 20		578460	
	F 26		578462	
	F 32		578464	
	F 16 S (PR-2B)	Mini Z8	574728	
	F 20 S (PR-2B)	Mini Z8	574730	
	F 26 S (PR-2B)	Mini Z8	574732	
	F 32 S (PR-2B)	Mini Z8	574734	
	H 16		578400	
	H 18		578404	
	H 20		578406	
	H 25		578408	
	H 26		578410	
	H 32		578412	
TH 16		578352		
TH 18		578356		
TH 20		578358		
TH 25		578360		
TH 26		578362		
TH 32		578364		
TH 16 S (PR-2B)	Mini Z8	574782		
TH 20 S (PR-2B)	Mini Z8	574788		
TH 26 S (PR-2B)	Mini Z8	574794		
TH 32 S (PR-2B)	Mini Z8	574798		
U 14		578372		
U 16		578374		
U 18		578376		
U 20		578378		
U 25		578380		
C 26		578392		
U 32		578382		
U 40		578386		
Nussbaum Optifitt-Press	VMP ¾" (OD 17,2 mm)		578660	
	VMP ½" (OD 21,3 mm)		578662	
Nussbaum Optiflex-Flowpress	VRX 16		578640	
	VRX 20		578642	
	VRX 25		578644	
	VRX 32		578646	
Nussbaum Optipress	V 15		578328	
	V 18		578332	
Aquaplus	V 22		578334	
	V 28		578336	
	V 35		578604	
	V 15 S (PR-2B)	Mini Z8	574752	
	V 18 S (PR-2B)	Mini Z8	574756	
	V 22 S (PR-2B)	Mini Z8	574758	
	V 28 S (PR-2B)	Mini Z8	574760	
	V 35 S (PR-2B)	Mini Z8	574762	
	Nussbaum Optipress Gaz	V 15		578328
		V 18		578332
V 22			578334	
V 28			578336	
V 35			578604	
V 15 S (PR-2B)		Mini Z8	574752	
V 18 S (PR-2B)		Mini Z8	574756	
V 22 S (PR-2B)		Mini Z8	574758	
V 28 S (PR-2B)		Mini Z8	574760	
V 35 S (PR-2B)		Mini Z8	574762	
Nussbaum Optipress-Therm	V 15		578328	
	V 18		578332	
	V 22		578334	
	V 28		578336	
	V 35		578604	
	V 15 S (PR-2B)	Mini Z8	574752	
	V 18 S (PR-2B)	Mini Z8	574756	
	V 22 S (PR-2B)	Mini Z8	574758	
	V 28 S (PR-2B)	Mini Z8	574760	
	V 35 S (PR-2B)	Mini Z8	574762	

Pressfitting systems for gas installations must only be pressed with REMS pressing tongs Mini/pressing rings which are highlighted in yellow.

Observe the national regulations. Read and observe the instructions for use and the installation instructions of the system provider/manufacturer.

- Only pressing tongs from designation "108" (1st quarter of 2008), "208" (2nd quarter of 2008) etc. can be used. The designation is stamped on every pressing jaw.
- For taking suitable pressing inserts.
- Only pressing tongs from designation "117" (1st quarter of 2017), "217" (2nd quarter of 2017) etc. can be used. The designation is stamped on every pressing jaw.
- For pipes of the EN technical standard. Observe the instructions for use of the system provider/manufacturer.
- For pipes of the ASTM technical standard. Observe the instructions for use of the system provider/manufacturer.

The suitability of REMS pressing tools for pressfitting systems: Date 12.10.2022. For the updated situation regarding suitability status check our website:

www.rems.de > Downloads > Product catalogues, brochures > REMS Catalogue.

See page 180 for adapter tongs. Pressing tongs for additional pressfitting systems on request.

REMS pressing tongs Mini REMS pressing rings

Accessories for REMS radial presses 22 kN

System	Pressing tongs / pressing rings	Driven by adapter tongs	Art.-No.
O			
Oventrop Cofit P	H 16 A H 20 A H 26 A H 32 A		578420 578426 578430 578432
Oventrop Cofit PD	H 16 A H 20 A H 26 A		578420 578426 578430
Oventrop Cofit PDK	H 16 A H 20 A		578420 578426
Oventrop Cofit PD-HT	H 16 A H 20 A H 32 A		578420 578426 578432
Oventrop Cofit PDK-HT	H 16 A H 20 A		578420 578426
P			
PBTub SERTIPRESS	Rfz 12 Rfz 16 Rfz 20 Rfz 25		578490 578492 578494 578496
PBTub SERTI-STEEL ¹⁾	M 15 M 18 M 22 M 28 M 15 S (PR-2B) M 18 S (PR-2B) M 22 S (PR-2B) M 28 S (PR-2B)		578312 578314 578316 578318 574738 574740 574742 574744
Pegler Yorkshire XPress Carbon	M 12 M 15 M 18 ¹⁾ M 22 M 28 ¹⁾ M 35 M 12 S (PR-2B) M 15 S (PR-2B) M 18 S (PR-2B) M 22 S (PR-2B) M 28 S (PR-2B) M 35 S (PR-2B)		578310 578312 578314 578316 578318 578390 574736 574738 574740 574742 574744 574746
Pegler Yorkshire XPress Copper	M 12 M 15 M 18 ¹⁾ M 22 M 28 ¹⁾ M 35 M 12 S (PR-2B) M 15 S (PR-2B) M 18 S (PR-2B) M 22 S (PR-2B) M 28 S (PR-2B) M 35 S (PR-2B)		578310 578312 578314 578316 578318 578390 574736 574738 574740 574742 574744 574746
Pegler Yorkshire XPress Copper Gas	M 15 M 18 ¹⁾ M 22 M 28 ¹⁾ M 35		578312 578314 578316 578318 578390
Pegler Yorkshire XPress Stainless	M 15 M 18 ¹⁾ M 22 M 28 ¹⁾ M 35 M 15 S (PR-2B) M 18 S (PR-2B) M 22 S (PR-2B) M 28 S (PR-2B) M 35 S (PR-2B)		578312 578314 578316 578318 578390 574738 574740 574742 574744 574746
Pegler Yorkshire XPress Stainless Gas	M 15 M 18 ¹⁾ M 22 M 28 ¹⁾ M 35		578312 578314 578316 578318 578390
PERFEXIM PERFEKT SYSTEM	U 16 U 20 U 25 U 32		578374 578378 578380 578382
PERFILTUBO PERFILALUPEX	U 16 U 18 U 20 U 25 U 32 U 40		578374 578376 578378 578380 578382 578386
PERFILTUBO PERFILPRESS	M 15 M 18 M 22 M 28 M 35 M 15 S (PR-2B) M 18 S (PR-2B) M 22 S (PR-2B) M 28 S (PR-2B) M 35 S (PR-2B)		578312 578314 578316 578318 578390 574738 574740 574742 574744 574746
PEXTUBE PexTube	Rfz 16 Rfz 20 Rfz 25 Rfz 32		578492 578494 578496 578498

System	Pressing tongs / pressing rings	Driven by adapter tongs	Art.-No.
Pipelife C-PRESS	M 15 M 18 M 22 M 28 M 35 M 15 S (PR-2B) M 18 S (PR-2B) M 22 S (PR-2B) M 28 S (PR-2B) M 35 S (PR-2B)		578312 578314 578316 578318 578390 574738 574740 574742 574744 574746
Pipelife RADOPRESS	TH 16 TH 18 TH 20 TH 26 TH 32 TH 40 TH 16 S (PR-2B) TH 20 S (PR-2B) TH 26 S (PR-2B) TH 32 S (PR-2B)		578352 578356 578358 578362 578364 578624 574782 574788 574794 574798
Pipetec Connect	TH 16 TH 20 TH 26 TH 32 TH 40 TH 16 S (PR-2B) TH 20 S (PR-2B) TH 26 S (PR-2B) TH 32 S (PR-2B) U 16 U 20 U 25 U 32		578352 578358 578362 578364 578624 574782 574788 574794 574798 578374 578378 578380 578382
PLASTICA ALFA Multypex	TH 16 TH 20 TH 26 TH 32 TH 16 S (PR-2B) TH 20 S (PR-2B) TH 26 S (PR-2B) TH 32 S (PR-2B)		578352 578358 578362 578364 574782 574788 574794 574798
PLASTICA ALFA Multypex Air	TH 16 TH 20 TH 26 TH 32 TH 16 S (PR-2B) TH 20 S (PR-2B) TH 26 S (PR-2B) TH 32 S (PR-2B)		578352 578358 578362 578364 574782 574788 574794 574798
PLASTICA ALFA Multypex alfa Gas	TH 16 TH 20 TH 26 TH 16 S (PR-2B) TH 20 S (PR-2B) TH 26 S (PR-2B)		578352 578358 578362 574782 574788 574794
PLASTICA ALFA Multypex alfa Gas protek	TH 16 TH 20 TH 26 TH 16 S (PR-2B) TH 20 S (PR-2B) TH 26 S (PR-2B)		578352 578358 578362 574782 574788 574794
PLASTICA ALFA Multypex Plus	TH 16 TH 20 TH 26 TH 32 TH 16 S (PR-2B) TH 20 S (PR-2B) TH 26 S (PR-2B) TH 32 S (PR-2B)		578352 578358 578362 578364 574782 574788 574794 574798
PLASTICA ALFA Multypex Thermo	TH 16 TH 20 TH 26 TH 32 TH 16 S (PR-2B) TH 20 S (PR-2B) TH 26 S (PR-2B) TH 32 S (PR-2B)		578352 578358 578362 578364 574782 574788 574794 574798
PLASTICA ALFA Multypex Thermo Plus	TH 16 TH 20 TH 26 TH 32 TH 16 S (PR-2B) TH 20 S (PR-2B) TH 26 S (PR-2B) TH 32 S (PR-2B)		578352 578358 578362 578364 574782 574788 574794 574798
PLÁSTICOS FERRO FERROPLAST GPF MULT Pressfitting MULTICAPA	U 16 U 20 U 25 U 32		578374 578378 578380 578382
PLÁSTICOS FERRO FERROPLAST GPF PPSU Pressfitting PEX y MULTICAPA	U 16 U 20 U 25 U 32		578374 578378 578380 578382
PLÁSTICOS FERRO FERROPLAST GPF PRESS Pressfitting PEX	Rfz 16 Rfz 20 Rfz 25 Rfz 32		578492 578494 578496 578498

REMS pressing tongs Mini

REMS pressing rings

Accessories for REMS radial presses 22 kN

System	Pressing tongs / pressing rings	Driven by adapter tongs	Art.-No.
PLUMBING PLUS EZIPEX Crimp (AUS)	K14/P18		578592
	K/20		578594
	K/25		578596
	K32		578598
	K1/40		578600
PLUMBING PLUS EZIPEX Gas (AUS)	K16/P18		578592
	K/20		578594
	K/25		578596
	K32		578598
	K1/40		578600
PLUMBING PLUS UNIPEX Water & Gas (AUS)	Yz 16 UNI		578740
	Yz 20 UNI		578742
	Yz 25 UNI		578744
	Yz 32 UNI		578746
PLUMBING PLUS EZIPRESS Gas (AUS)	VAU 15 (OD 12,7 mm)		578630
	VAU 20 (OD 19,1 mm)		578632
	VAU 25 (OD 25,4 mm)		578634
	VAU 32 (OD 31,8 mm)		578636
	VAU 15 S (PR-2B) (OD 12,7 mm)	Mini Z8	574804
	VAU 20 S (PR-2B) (OD 19,1 mm)	Mini Z8	574806
PLUMBING PLUS EZIPRESS Solar (AUS)	VAU 25 S (PR-2B) (OD 25,4 mm)	Mini Z8	574808
	VAU 15 (OD 12,7 mm)		578630
	VAU 20 (OD 19,1 mm)		578632
	VAU 25 (OD 25,4 mm)		578634
PLUMBING PLUS EZIPRESS Water (AUS)	VAU 32 (OD 31,8 mm)		578636
	VAU 15 S (PR-2B) (OD 12,7 mm)	Mini Z8	574804
	VAU 20 S (PR-2B) (OD 19,1 mm)	Mini Z8	574806
	VAU 25 S (PR-2B) (OD 25,4 mm)	Mini Z8	574808
	TH 10		578342
	TH 15		578350
POLYPIPE POLYSURE	TH 22		578588
	TH 28		578590
	M 15		578312
	M 18		578314
POLYSAN Handelsges. m.b.H. & Co KG (Krems/Öster- reich)	M 22		578316
	M 28		578318
	M 35		578390
	M 15 S (PR-2B)	Mini Z8	574738
POLYSAN- C Stahl-Press- System M	M 18 S (PR-2B)	Mini Z8	574740
	M 22 S (PR-2B)	Mini Z8	574742
	M 28 S (PR-2B)	Mini Z8	574744
	M 35 S (PR-2B)	Mini Z8	574746
POLYSAN Handelsges. m.b.H. & Co KG (Krems/Öster- reich)	M 15		578312
	M 18		578314
	M 22		578316
	M 28		578318
	M 35		578390
POLYSAN- Edelstahl Press-System 1.4520	M 15 S (PR-2B)	Mini Z8	574738
	M 18 S (PR-2B)	Mini Z8	574740
	M 22 S (PR-2B)	Mini Z8	574742
	M 28 S (PR-2B)	Mini Z8	574744
POLYSAN Handelsges. m.b.H. & Co KG (Krems/Öster- reich)	M 35 S (PR-2B)	Mini Z8	574746
	M 15		578312
	M 18		578314
	M 22		578316
	M 28		578318
POLYSAN- Edelstahl Press-System Gas	M 35		578390
	M 15 S (PR-2B)	Mini Z8	574738
	M 18 S (PR-2B)	Mini Z8	574740
	M 22 S (PR-2B)	Mini Z8	574742
	M 28 S (PR-2B)	Mini Z8	574744
POLYSAN Handelsges. m.b.H. & Co KG (Krems/Öster- reich)	M 35 S (PR-2B)	Mini Z8	574746
	M 15		578312
	M 18		578314
	M 22		578316
	M 28		578318
POLYSAN- Edelstahl Press-System Wasser	M 35		578390
	M 15 S (PR-2B)	Mini Z8	574738
	M 18 S (PR-2B)	Mini Z8	574740
	M 22 S (PR-2B)	Mini Z8	574742
POLYSAN Handelsges. m.b.H. & Co KG (Krems/Öster- reich)	M 28 S (PR-2B)	Mini Z8	574744
	M 35 S (PR-2B)	Mini Z8	574746
	TH 14		578348
	TH 16		578352
	TH 17		578354
	TH 18		578356
	TH 20		578358
	TH 26		578362
POLYSAN- Press-System	TH 32		578364
	TH 40		578424
	TH 16 S (PR-2B)	Mini Z8	574782
	TH 20 S (PR-2B)	Mini Z8	574788
	TH 26 S (PR-2B)	Mini Z8	574794
	TH 32 S (PR-2B)	Mini Z8	574798

System	Pressing tongs / pressing rings	Driven by adapter tongs	Art.-No.	
POLYSAN Handelsges. m.b.H. & Co KG (Krems/Öster- reich)	TH 14		578348	
	TH 16		578352	
	TH 17		578354	
	TH 18		578356	
	TH 20		578358	
	POLYSAN-Henco- Press-System	TH 26		578362
		HE 32		578370
		HEz 40 ³⁾		578572
		TH 16 S (PR-2B)	Mini Z8	574782
		TH 20 S (PR-2B)	Mini Z8	574788
		TH 26 S (PR-2B)	Mini Z8	574794
		U 16		578374
	POLYSAN (España) „Rainbow“	U 18		578376
U 20			578378	
U 25			578380	
U 32			578382	
Prandelli Multyrama Pf	U 40		578386	
	H 14		578398	
	H 16		578400	
	H 18		578404	
Prandelli Multyrama Pfm	H 20		578406	
	H 26		578412	
	H 32		578386	
	U 40		578400	
	H 16		578404	
	H 18		578406	
	H 20		578410	
	H 26		578412	
	H 32		578352	
	TH 16		578356	
PURMO Cleverfit Radial	TH 18		578358	
	TH 20		578362	
	TH 26		578364	
	TH 32		578624	
	TH 40		574782	
	TH 16 S (PR-2B)	Mini Z8	574788	
	TH 20 S (PR-2B)	Mini Z8	574794	
	TH 26 S (PR-2B)	Mini Z8	574798	
	TH 32 S (PR-2B)	Mini Z8	578374	
	U 16		578376	
	U 18		578378	
	U 20		578386	
	R	F 16		578456
F 20			578460	
F 26			578462	
F 32			578464	
F 16 S (PR-2B)		Mini Z8	574728	
F 20 S (PR-2B)		Mini Z8	574730	
F 26 S (PR-2B)		Mini Z8	574732	
F 32 S (PR-2B)		Mini Z8	574734	
H 16			578400	
H 20			578406	
H 26			578410	
H 32			578412	
TH 14			578348	
TH 16		578352		
TH 17		578354		
TH 18		578356		
TH 20		578358		
TH 26		578362		
TH 32		578364		
TH 40		578624		
TH 16 S (PR-2B)	Mini Z8	574782		
TH 20 S (PR-2B)	Mini Z8	574788		
TH 26 S (PR-2B)	Mini Z8	574794		
TH 32 S (PR-2B)	Mini Z8	574798		
U 16		578374		
U 20		578378		
U 32		578382		
VP 16		578482		
VP 20		578484		
VP 32		578488		
Raccorderie Metalliche aesPRES ⁴⁾	M 15		578312	
	M 18		578314	
	M 22		578316	
	M 28		578318	
	M 35		578390	
	M 15 S (PR-2B)	Mini Z8	574738	
M 18 S (PR-2B)	Mini Z8	574740		
M 22 S (PR-2B)	Mini Z8	574742		
M 28 S (PR-2B)	Mini Z8	574744		
M 35 S (PR-2B)	Mini Z8	574746		

Pressfitting systems for gas installations must only be pressed with REMS pressing tongs Mini/pressing rings which are highlighted in yellow.

Observe the national regulations. Read and observe the instructions for use and the installation instructions of the system provider/manufacturer.

- 1) Only pressing tongs from designation "108" (1st quarter of 2008), "208" (2nd quarter of 2008) etc. can be used. The designation is stamped on every pressing jaw.
- 2) For taking suitable pressing inserts.
- 3) Only pressing tongs from designation "117" (1st quarter of 2017), "217" (2nd quarter of 2017) etc. can be used. The designation is stamped on every pressing jaw.
- 4) For pipes of the EN technical standard. Observe the instructions for use of the system provider/manufacturer.
- 5) For pipes of the ASTM technical standard. Observe the instructions for use of the system provider/manufacturer.

The suitability of REMS pressing tools for pressfitting systems: Date 12.10.2022. For the updated situation regarding suitability status check our website: www.rems.de > Downloads > Product catalogues, brochures > REMS Catalogue.

See page 180 for adapter tongs. Pressing tongs for additional pressfitting systems on request.

REMS pressing tongs Mini REMS pressing rings

Accessories for REMS radial presses 22 kN

System	Pressing tongs / pressing rings	Driven by adapter tongs	Art.-No.
Raccorderie Metalliche inoxPRES ⁹	M 15		578312
	M 18		578314
	M 22		578316
	M 28		578318
	M 35		578390
	M 15 S (PR-2B)	Mini Z8	574738
	M 18 S (PR-2B)	Mini Z8	574740
	M 22 S (PR-2B)	Mini Z8	574742
Raccorderie Metalliche MARINEPRES ⁹	M 15		578312
	M 18		578314
	M 22		578316
	M 28		578318
	M 35		578390
	M 15 S (PR-2B)	Mini Z8	574738
	M 18 S (PR-2B)	Mini Z8	574740
	M 22 S (PR-2B)	Mini Z8	574742
Raccorderie Metalliche steelPRES ⁹	M 15		578312
	M 18		578314
	M 22		578316
	M 28		578318
	M 35		578390
	M 15 S (PR-2B)	Mini Z8	574738
	M 18 S (PR-2B)	Mini Z8	574740
	M 22 S (PR-2B)	Mini Z8	574742
RBM Tita-fix	M 28 S (PR-2B)	Mini Z8	574744
	M 35 S (PR-2B)	Mini Z8	574746
	B 14		578466
	B 16		578468
	B 18		578470
	B 20		578472
	B 26		578474
	F 16		578456
	F 18		578458
	F 20		578460
	F 16 S (PR-2B)	Mini Z8	574728
	F 20 S (PR-2B)	Mini Z8	574730
	H 14		578398
	H 16		578400
	H 18		578404
	H 20		578406
	H 26		578410
	H 32		578412
	TH 14		578348
	TH 16		578352
	TH 18		578356
	TH 20		578358
	TH 26		578362
	TH 32		578364
	TH 40		578624
	TH 16 S (PR-2B)	Mini Z8	574782
	TH 20 S (PR-2B)	Mini Z8	574788
	TH 26 S (PR-2B)	Mini Z8	574794
	TH 32 S (PR-2B)	Mini Z8	574798
	U 14		578372
	U 16		578374
	U 18		578376
	U 20		578378
RBM Tita-gas	U 20		578378
	TH 16		578352
	TH 20		578358
	TH 26		578362
	TH 32		578364
	TH 16 S (PR-2B)	Mini Z8	574782
	TH 20 S (PR-2B)	Mini Z8	574788
	TH 26 S (PR-2B)	Mini Z8	574794
TH 32 S (PR-2B)	Mini Z8	574798	
Redi Nicoll Fluxo	TH 14		578348
	TH 16		578352
	TH 18		578356
	TH 20		578358
	TH 26		578362
	TH 32		578364
	TH 40		578624
	TH 16 S (PR-2B)	Mini Z8	574782
TH 20 S (PR-2B)	Mini Z8	574788	
Redi Nicoll Fluxo Gas	TH 26 S (PR-2B)	Mini Z8	574794
	TH 32 S (PR-2B)	Mini Z8	574798
	TH 16		578352
	TH 20		578358
	TH 26		578362
	TH 16 S (PR-2B)	Mini Z8	574782
	TH 20 S (PR-2B)	Mini Z8	574788
	TH 26 S (PR-2B)	Mini Z8	574794
TH 32 S (PR-2B)	Mini Z8	574798	
RIFENG LD PRESS FITTING (F8)	LD 16		578652
	LD 20		578654
	LD 25		578656
RIFENG U PRESS FITTING (F5)	U 14		578372
	U 16		578374
	U 18		578376
	U 20		578378
	U 25		578380
	U 32		578382
RIFENG TH PRESS FITTING (F9)	U 40		578386
	TH 16		578352
	TH 20		578358
	TH 25		578360
	TH 26		578362
RIQUIER A SERTIR	TH 32		578364
	TH 40		578624
	Rfz 12		578490
	Rfz 16		578492
	Rfz 20		578494
	Rfz 25		578496

System	Pressing tongs / pressing rings	Driven by adapter tongs	Art.-No.
Roth PressCheck	RN 14		578434
	RN 16		578454
	RN 17		578436
	RN 20		578438
	RN 25/26		578440
	RN 32		578442
Rubinetteria Bresciane Bonomi TURBO CuNi	M 15		578312
	M 18		578314
	M 22		578316
	M 28		578318
	M 35		578390
	M 15 S (PR-2B)	Mini Z8	574738
	M 18 S (PR-2B)	Mini Z8	574740
	M 22 S (PR-2B)	Mini Z8	574742
	M 28 S (PR-2B)	Mini Z8	574744
	M 35 S (PR-2B)	Mini Z8	574746
Rubinetteria Bresciane Bonomi TURBO INOX	M 15		578312
	M 18		578314
	M 22		578316
	M 28		578318
	M 35		578390
	M 15 S (PR-2B)	Mini Z8	574738
	M 18 S (PR-2B)	Mini Z8	574740
	M 22 S (PR-2B)	Mini Z8	574742
	M 28 S (PR-2B)	Mini Z8	574744
	M 35 S (PR-2B)	Mini Z8	574746
Rubinetteria Bresciane Bonomi TURBO INOX GAS	M 15		578312
	M 18		578314
	M 22		578316
	M 28		578318
	M 35		578390
	M 15 S (PR-2B)	Mini Z8	574738
	M 18 S (PR-2B)	Mini Z8	574740
	M 22 S (PR-2B)	Mini Z8	574742
	M 28 S (PR-2B)	Mini Z8	574744
	M 35 S (PR-2B)	Mini Z8	574746
Rubinetteria Bresciane Bonomi TURBO STEEL	M 15		578312
	M 18		578314
	M 22		578316
	M 28		578318
	M 35		578390
	M 15 S (PR-2B)	Mini Z8	574738
	M 18 S (PR-2B)	Mini Z8	574740
	M 22 S (PR-2B)	Mini Z8	574742
	M 28 S (PR-2B)	Mini Z8	574744
	M 35 S (PR-2B)	Mini Z8	574746
Rubinetteria Bresciane Bonomi TURBO PRESS	B 14		578466
	B 16		578468
	B 18		578470
	B 20		578472
	B 26		578474
	B 32		578476
	H 14		578398
	H 16		578400
	H 18		578404
	H 20		578406
	H 26		578410
	H 32		578412
	TH 14		578348
	TH 16		578352
	TH 18		578356
	TH 20		578358
	TH 26		578362
	TH 32		578364
	TH 40		578624
	TH 16 S (PR-2B)	Mini Z8	574782
TH 20 S (PR-2B)	Mini Z8	574788	
TH 26 S (PR-2B)	Mini Z8	574794	
TH 32 S (PR-2B)	Mini Z8	574798	
U 14		578372	
U 16		578374	
U 18		578376	
U 20		578378	
C 26		578392	
U 32		578382	
Rubinetteria Bresciane Bonomi TURBO PRESS GAS	TH 16		578352
	TH 20		578358
	TH 26		578362
	TH 32		578364
	TH 16 S (PR-2B)	Mini Z8	574782
TH 20 S (PR-2B)	Mini Z8	574788	
TH 26 S (PR-2B)	Mini Z8	574794	
TH 32 S (PR-2B)	Mini Z8	574798	
S			
SA.MI plastic	TH 14		578348
	TH 16		578352
	TH 18		578356
	TH 20		578358
	TH 26		578362
	TH 32		578364
	TH 40		578624
	TH 16 S (PR-2B)	Mini Z8	574782
	TH 20 S (PR-2B)	Mini Z8	574788
	TH 26 S (PR-2B)	Mini Z8	574794
SA.MI plastic Multistrato Gas	TH 32 S (PR-2B)	Mini Z8	574798
	TH 16		578352
	TH 20		578358
	TH 26		578362
	TH 32		578364
	TH 16 S (PR-2B)	Mini Z8	574782
TH 20 S (PR-2B)	Mini Z8	574788	
TH 26 S (PR-2B)	Mini Z8	574794	
TH 32 S (PR-2B)	Mini Z8	574798	

REMS pressing tongs Mini REMS pressing rings

Accessories for REMS radial presses 22 kN

System	Pressing tongs/ pressing rings	Driven by adapter tongs	Art.-No.	System	Pressing tongs/ pressing rings	Driven by adapter tongs	Art.-No.		
SANHA 3fit-Press Pb-free Serie 25000	B 16		578468	SANHA-NiroSan Industry Presssystem Serie 18000	SA 15		578514		
	B 20		578472		SA 18		578518		
	B 26		578474		SA 22		578520		
	B 32		578476		SA 28		578522		
	F 16		578456		M 15 ¹⁾		578312		
	F 20		578460		M 18 ¹⁾		578314		
	F 26		578462		M 22 ¹⁾		578316		
	F 32		578464		M 28		578318		
	Fz 40		578478		M 35		578390		
	F 16 S (PR-2B)	Mini Z8	574728		M 15 S (PR-2B)	Mini Z8	574738		
	F 20 S (PR-2B)	Mini Z8	574730		M 18 S (PR-2B)	Mini Z8	574740		
	F 26 S (PR-2B)	Mini Z8	574732		M 22 S (PR-2B)	Mini Z8	574742		
	F 32 S (PR-2B)	Mini Z8	574734		M 28 S (PR-2B)	Mini Z8	574744		
	H 16		578400		M 35 S (PR-2B)	Mini Z8	574746		
	H 20		578406		V 15 ¹⁾		578328		
	H 26		578410		V 18 ¹⁾		578332		
	H 32		578412		V 22 ¹⁾		578334		
	TH 16		578352		V 28		578336		
	TH 20		578358		V 35		578604		
	TH 26		578362		V 15 S (PR-2B)	Mini Z8	574752		
	TH 32		578364		V 18 S (PR-2B)	Mini Z8	574756		
	TH 40		578624		V 22 S (PR-2B)	Mini Z8	574758		
	TH 16 S (PR-2B)	Mini Z8	574782		V 28 S (PR-2B)	Mini Z8	574760		
	TH 20 S (PR-2B)	Mini Z8	574788		V 35 S (PR-2B)	Mini Z8	574762		
	TH 26 S (PR-2B)	Mini Z8	574794						
	TH 32 S (PR-2B)	Mini Z8	574798						
	U 16		578374						
	U 20		578378						
	C 26		578392						
	U 32		578382						
	U 40		578386						
	SANHA 3fit-Press PPSU Serie 35000	B 16			578468	SANHA-NiroSan- Presssystem Serie 9000	SA 15		578514
		B 20			578472		SA 18		578518
B 26			578474	SA 22			578520		
B 32			578476	SA 28			578522		
F 16			578456	M 15 ¹⁾			578312		
F 20			578460	M 18 ¹⁾			578314		
F 26			578462	M 22 ¹⁾			578316		
F 32			578464	M 28			578318		
F 16 S (PR-2B)		Mini Z8	574728	M 35			578390		
F 20 S (PR-2B)		Mini Z8	574730	M 15 S (PR-2B)	Mini Z8		574738		
F 26 S (PR-2B)		Mini Z8	574732	M 18 S (PR-2B)	Mini Z8		574740		
F 32 S (PR-2B)		Mini Z8	574734	M 22 S (PR-2B)	Mini Z8		574742		
H 16			578400	M 28 S (PR-2B)	Mini Z8		574744		
H 20			578406	M 35 S (PR-2B)	Mini Z8		574746		
H 26			578410	V 15 ¹⁾			578328		
H 32			578412	V 18 ¹⁾			578332		
TH 16			578352	V 22 ¹⁾			578334		
TH 20			578358	V 28			578336		
TH 26			578362	V 35			578604		
TH 32			578364	V 15 S (PR-2B)	Mini Z8		574752		
TH 16 S (PR-2B)		Mini Z8	574782	V 18 S (PR-2B)	Mini Z8		574756		
TH 20 S (PR-2B)		Mini Z8	574788	V 22 S (PR-2B)	Mini Z8		574758		
TH 26 S (PR-2B)		Mini Z8	574794	V 28 S (PR-2B)	Mini Z8		574760		
TH 32 S (PR-2B)		Mini Z8	574798	V 35 S (PR-2B)	Mini Z8		574762		
U 16			578374						
U 20			578378						
C 26			578392						
U 32			578382						
SANHA Heavy Steel Press		VMP ½" (OD 21,3 mm)		578662	SANHA-NiroSan SF Presssystem Serie 19000 (silicone free)		SA 15		578514
		VMPz ¾" (OD 26,9 mm)		578664			SA 18		578518
SANHA Heavy Steel Press Gas		VMP ½" (OD 21,3 mm)		578662	SA 22			578520	
		VMPz ¾" (OD 26,9 mm)		578664	SA 28			578522	
SANHA-NiroSan Gas Presssystem Serie 17000		SA 15		578514	M 15 ¹⁾			578312	
	SA 18		578518	M 18 ¹⁾		578314			
	SA 22		578520	M 22 ¹⁾		578316			
	SA 28		578522	M 28		578318			
	M 15 ¹⁾		578312	M 35		578390			
	M 18 ¹⁾		578314	M 15 S (PR-2B)	Mini Z8	574738			
	M 22 ¹⁾		578316	M 18 S (PR-2B)	Mini Z8	574740			
	M 28		578318	M 22 S (PR-2B)	Mini Z8	574742			
	M 35		578390	M 28 S (PR-2B)	Mini Z8	574744			
	M 15 S (PR-2B)	Mini Z8	574738	M 35 S (PR-2B)	Mini Z8	574746			
	M 18 S (PR-2B)	Mini Z8	574740	V 15 ¹⁾		578328			
	M 22 S (PR-2B)	Mini Z8	574742	V 18 ¹⁾		578332			
	M 28 S (PR-2B)	Mini Z8	574744	V 22 ¹⁾		578334			
	M 35 S (PR-2B)	Mini Z8	574746	V 28		578336			
	V 15 ¹⁾		578328	V 35		578604			
	V 18 ¹⁾		578332	V 15 S (PR-2B)	Mini Z8	574752			
	V 22 ¹⁾		578334	V 18 S (PR-2B)	Mini Z8	574756			
	V 28		578336	V 22 S (PR-2B)	Mini Z8	574758			
	V 35		578604	V 28 S (PR-2B)	Mini Z8	574760			
	V 15 S (PR-2B)	Mini Z8	574752	V 35 S (PR-2B)	Mini Z8	574762			

Pressfitting systems for gas installations must only be pressed with REMS pressing tongs Mini/pressing rings which are highlighted in yellow.

Observe the national regulations. Read and observe the instructions for use and the installation instructions of the system provider/manufacturer.

- 1) Only pressing tongs from designation "108" (1st quarter of 2008), "208" (2nd quarter of 2008) etc. can be used. The designation is stamped on every pressing jaw.
- 2) For taking suitable pressing inserts.
- 3) Only pressing tongs from designation "117" (1st quarter of 2017), "217" (2nd quarter of 2017) etc. can be used. The designation is stamped on every pressing jaw.
- 4) For pipes of the EN technical standard. Observe the instructions for use of the system provider/manufacturer.
- 5) For pipes of the ASTM technical standard. Observe the instructions for use of the system provider/manufacturer.

The suitability of REMS pressing tools for pressfitting systems: Date 12.10.2022. For the updated situation regarding suitability status check our website:

www.rems.de > Downloads > Product catalogues, brochures > REMS Catalogue.

See page 180 for adapter tongs. Pressing tongs for additional pressfitting systems on request.

REMS pressing tongs Mini REMS pressing rings

Accessories for REMS radial presses 22 kN

System	Pressing tongs / pressing rings	Driven by adapter tongs	Art.-No.	
SANHA NiroTherm Serie 91000	SA 15		578514	
	SA 18		578518	
	SA 22		578520	
	SA 28		578522	
	M 15 ¹⁾		578312	
	M 18 ¹⁾		578314	
	M 22 ¹⁾		578316	
	M 28		578318	
	M 35		578390	
	M 15 S (PR-2B)	Mini Z8	574738	
	M 18 S (PR-2B)	Mini Z8	574740	
	M 22 S (PR-2B)	Mini Z8	574742	
	M 28 S (PR-2B)	Mini Z8	574744	
	M 35 S (PR-2B)	Mini Z8	574746	
	V 15 ¹⁾		578328	
	V 18 ¹⁾		578332	
	V 22 ¹⁾		578334	
	V 28		578336	
	V 35		578604	
	V 15 S (PR-2B)	Mini Z8	574752	
	V 18 S (PR-2B)	Mini Z8	574756	
	V 22 S (PR-2B)	Mini Z8	574758	
	V 28 S (PR-2B)	Mini Z8	574760	
	V 35 S (PR-2B)	Mini Z8	574762	
	SANHA NiroTherm Industry Serie 98000	SA 15		578514
		SA 18		578518
		SA 22		578520
SA 28			578522	
M 15 ¹⁾			578312	
M 18 ¹⁾			578314	
M 22 ¹⁾			578316	
M 28			578318	
M 35			578390	
M 15 S (PR-2B)		Mini Z8	574738	
M 18 S (PR-2B)		Mini Z8	574740	
M 22 S (PR-2B)		Mini Z8	574742	
M 28 S (PR-2B)		Mini Z8	574744	
M 35 S (PR-2B)		Mini Z8	574746	
V 15 ¹⁾			578328	
V 18 ¹⁾			578332	
V 22 ¹⁾			578334	
V 28			578336	
V 35			578604	
V 15 S (PR-2B)		Mini Z8	574752	
V 18 S (PR-2B)		Mini Z8	574756	
V 22 S (PR-2B)		Mini Z8	574758	
V 28 S (PR-2B)		Mini Z8	574760	
V 35 S (PR-2B)		Mini Z8	574762	
SANHA-Press Chrom Serie 16000		SA 12		578510
		SA 15		578514
		SA 18		578518
	SA 22		578520	
	SA 28		578522	
	M 12		578310	
	M 15 ¹⁾		578312	
	M 18 ¹⁾		578314	
	M 22 ¹⁾		578316	
	M 28		578318	
	M 12 S (PR-2B)	Mini Z8	574736	
	M 15 S (PR-2B)	Mini Z8	574738	
	M 18 S (PR-2B)	Mini Z8	574740	
	M 22 S (PR-2B)	Mini Z8	574742	
	M 28 S (PR-2B)	Mini Z8	574744	
	V 12		578324	
	V 15 ¹⁾		578328	
	V 18 ¹⁾		578332	
	V 22 ¹⁾		578334	
	V 28		578336	
	V 12 S (PR-2B)	Mini Z8	574748	
	V 15 S (PR-2B)	Mini Z8	574752	
	V 18 S (PR-2B)	Mini Z8	574756	
	V 22 S (PR-2B)	Mini Z8	574758	
	V 28 S (PR-2B)	Mini Z8	574760	
	SANHA-Press GAS Pressfittings Serie 10000/ Serie 11000	SA 12		578510
		SA 14		578512
SA 15			578514	
SA 16			578516	
SA 18			578518	
SA 22			578520	
SA 28			578522	
M 12			578310	
M 15 ¹⁾			578312	
M 18 ¹⁾			578314	
M 22 ¹⁾			578316	
M 28			578318	
M 35			578390	
M 12 S (PR-2B)		Mini Z8	574736	
M 15 S (PR-2B)		Mini Z8	574738	
M 18 S (PR-2B)		Mini Z8	574740	
M 22 S (PR-2B)		Mini Z8	574742	
M 28 S (PR-2B)		Mini Z8	574744	
M 35 S (PR-2B)		Mini Z8	574746	
V 12			578324	
V 14			578326	
VG 14			578338	
V 15 ¹⁾			578328	
V 16			578330	
VG 16			578340	
V 18 ¹⁾			578332	
V 22 ¹⁾			578334	
V 28			578336	
V 35			578604	
V 12 S (PR-2B)		Mini Z8	574748	
VG 14 S (PR-2B)		Mini Z8	574750	
V 15 S (PR-2B)		Mini Z8	574752	
VG 16 S (PR-2B)		Mini Z8	574754	
V 18 S (PR-2B)	Mini Z8	574756		
V 22 S (PR-2B)	Mini Z8	574758		
V 28 S (PR-2B)	Mini Z8	574760		
V 35 S (PR-2B)	Mini Z8	574762		

System	Pressing tongs / pressing rings	Driven by adapter tongs	Art.-No.
SANHA-Press Pressfittings Serie 6000	SA 12		578510
	SA 14		578512
	SA 15		578514
	SA 16		578516
	SA 18		578518
	SA 22		578520
	SA 28		578522
	M 12		578310
	M 15 ¹⁾		578312
	M 18 ¹⁾		578314
	M 22 ¹⁾		578316
	M 28		578318
	M 35		578390
	M 12 S (PR-2B)	Mini Z8	574736
	M 15 S (PR-2B)	Mini Z8	574738
	M 18 S (PR-2B)	Mini Z8	574740
	M 22 S (PR-2B)	Mini Z8	574742
	M 28 S (PR-2B)	Mini Z8	574744
	M 35 S (PR-2B)	Mini Z8	574746
	V 12		578324
	V 14		578326
	VG 14		578338
	V 15 ¹⁾		578328
	V 16		578330
	VG 16		578340
	V 18 ¹⁾		578332
	V 22 ¹⁾		578334
V 28		578336	
V 35		578604	
V 12 S (PR-2B)	Mini Z8	574748	
VG 14 S (PR-2B)	Mini Z8	574750	
V 15 S (PR-2B)	Mini Z8	574752	
VG 16 S (PR-2B)	Mini Z8	574754	
V 18 S (PR-2B)	Mini Z8	574756	
V 22 S (PR-2B)	Mini Z8	574758	
V 28 S (PR-2B)	Mini Z8	574760	
V 35 S (PR-2B)	Mini Z8	574762	
SANHA-Press SOLAR Pressfittings Serie 12000/ Serie 13000	SA 12		578510
	SA 15		578514
	SA 18		578518
	SA 22		578520
	SA 28		578522
	M 12		578310
	M 15 ¹⁾		578312
	M 18 ¹⁾		578314
	M 22 ¹⁾		578316
	M 28		578318
	M 35		578390
	M 12 S (PR-2B)	Mini Z8	574736
	M 15 S (PR-2B)	Mini Z8	574738
	M 18 S (PR-2B)	Mini Z8	574740
	M 22 S (PR-2B)	Mini Z8	574742
	M 28 S (PR-2B)	Mini Z8	574744
	M 35 S (PR-2B)	Mini Z8	574746
	V 12		578324
	V 15 ¹⁾		578328
	V 18 ¹⁾		578332
	V 22 ¹⁾		578334
	V 28		578336
	V 35		578604
	V 12 S (PR-2B)	Mini Z8	574748
	V 15 S (PR-2B)	Mini Z8	574752
	V 18 S (PR-2B)	Mini Z8	574756
	V 22 S (PR-2B)	Mini Z8	574758
V 28 S (PR-2B)	Mini Z8	574760	
V 35 S (PR-2B)	Mini Z8	574762	
SANHA PURAPRESS Serie 8000	SA 12		578510
	SA 14		578512
	SA 15		578514
	SA 16		578516
	SA 18		578518
	SA 22		578520
	SA 28		578522
	M 12 ¹⁾		578310
	M 15 ¹⁾		578312
	M 18 ¹⁾		578314
	M 22 ¹⁾		578316
	M 28 ¹⁾		578318
	M 35 ¹⁾		578390
	M 12 S (PR-2B)	Mini Z8	574736
	M 15 S (PR-2B)	Mini Z8	574738
	M 18 S (PR-2B)	Mini Z8	574740
	M 22 S (PR-2B)	Mini Z8	574742
	M 28 S (PR-2B)	Mini Z8	574744
	M 35 S (PR-2B)	Mini Z8	574746
	V 12		578324
	V 14		578326
	VG 14		578338
	V 15 ¹⁾		578328
	V 16		578330
	VG 16		578340
	V 18 ¹⁾		578332
	V 22 ¹⁾		578334
V 28		578336	
V 35		578604	
V 12 S (PR-2B)	Mini Z8	574748	
VG 14 S (PR-2B)	Mini Z8	574750	
V 15 S (PR-2B)	Mini Z8	574752	
VG 16 S (PR-2B)	Mini Z8	574754	
V 18 S (PR-2B)	Mini Z8	574756	
V 22 S (PR-2B)	Mini Z8	574758	
V 28 S (PR-2B)	Mini Z8	574760	
V 35 S (PR-2B)	Mini Z8	574762	

REMS pressing tongs Mini

REMS pressing rings

Accessories for REMS radial presses 22 kN

System	Pressing tongs / pressing rings	Driven by adapter tongs	Art.-No.	
SANHA-Therm Serie 24000	SA 12		578510	
	SA 15		578514	
	SA 18		578518	
	SA 22		578520	
	SA 28		578522	
	M 12		578310	
	M 15 ¹⁾		578312	
	M 18 ¹⁾		578314	
	M 22 ¹⁾		578316	
	M 28		578318	
	M 35		578390	
	M 12 S (PR-2B)	Mini Z8	574736	
	M 15 S (PR-2B)	Mini Z8	574738	
	M 18 S (PR-2B)	Mini Z8	574740	
	M 22 S (PR-2B)	Mini Z8	574742	
	M 28 S (PR-2B)	Mini Z8	574744	
	M 35 S (PR-2B)	Mini Z8	574746	
	V 12		578324	
	V 15 ¹⁾		578328	
	V 18 ¹⁾		578332	
	V 22 ¹⁾		578334	
	V 28		578336	
	V 35		578604	
	V 12 S (PR-2B)	Mini Z8	574748	
	V 15 S (PR-2B)	Mini Z8	574752	
	V 18 S (PR-2B)	Mini Z8	574756	
	V 22 S (PR-2B)	Mini Z8	574758	
	V 28 S (PR-2B)	Mini Z8	574760	
	V 35 S (PR-2B)	Mini Z8	574762	
	SANHA-Therm Industry Serie 28000	SA 12		578510
		SA 15		578514
		SA 18		578518
		SA 22		578520
SA 28			578522	
M 12			578310	
M 15 ¹⁾			578312	
M 18 ¹⁾			578314	
M 22 ¹⁾			578316	
M 28			578318	
M 35			578390	
M 12 S (PR-2B)		Mini Z8	574736	
M 15 S (PR-2B)		Mini Z8	574738	
M 18 S (PR-2B)		Mini Z8	574740	
M 22 S (PR-2B)		Mini Z8	574742	
M 28 S (PR-2B)		Mini Z8	574744	
M 35 S (PR-2B)		Mini Z8	574746	
V 12			578324	
V 15 ¹⁾			578328	
V 18 ¹⁾			578332	
V 22 ¹⁾			578334	
V 28			578336	
V 35			578604	
V 12 S (PR-2B)		Mini Z8	574748	
V 15 S (PR-2B)		Mini Z8	574752	
V 18 S (PR-2B)		Mini Z8	574756	
V 22 S (PR-2B)		Mini Z8	574758	
V 28 S (PR-2B)		Mini Z8	574760	
V 35 S (PR-2B)		Mini Z8	574762	
SANITOP PERMATUBO INOX		M 15		578312
		M 18		578314
		M 22		578316
		M 28		578318
	M 35		578390	
	M 15 S (PR-2B)	Mini Z8	574738	
	M 18 S (PR-2B)	Mini Z8	574740	
	M 22 S (PR-2B)	Mini Z8	574742	
	M 28 S (PR-2B)	Mini Z8	574744	
	M 35 S (PR-2B)	Mini Z8	574746	
	SANPRO THPRESS	TH 16		578352
		TH 20		578358
		TH 26		578362
		TH 32		578364
		TH 16 S (PR-2B)	Mini Z8	574782
TH 20 S (PR-2B)		Mini Z8	574788	
TH 26 S (PR-2B)		Mini Z8	574794	
TH 32 S (PR-2B)		Mini Z8	574798	
SATEC SK VITerm	TH 16		578352	
	TH 18		578356	
	TH 20		578358	
	TH 26		578362	
	TH 32		578364	
	U 40		578386	
	SAVEUR REFLEX PEX Water	TH 16		578352
TH 20			578358	
TH 25			578360	
TH 32			578364	

System	Pressing tongs / pressing rings	Driven by adapter tongs	Art.-No.	
SAVEUR REFLEX PEX-AL-PEX Gas	TH 16		578352	
	TH 20		578358	
	TH 25		578360	
	TH 32		578364	
Schütz duo-flex tri-o-flex	TH 14		578348	
	TH 16		578352	
	TH 17		578354	
	TH 20		578358	
	TH 25		578360	
	TH 16 S (PR-2B) TH 20 S (PR-2B)	Mini Z8 Mini Z8	574782 574788	
Schwer Fittings AQUApress	M 12		578310	
	M 15		578312	
	M 18		578314	
	M 22		578316	
	M 28		578318	
	M 35		578390	
	M 12 S (PR-2B)	Mini Z8	574736	
	M 15 S (PR-2B)	Mini Z8	574738	
	M 18 S (PR-2B)	Mini Z8	574740	
	M 22 S (PR-2B)	Mini Z8	574742	
	M 28 S (PR-2B)	Mini Z8	574744	
	M 35 S (PR-2B)	Mini Z8	574746	
Seppelfricke VSH SudoPress C-Stahl Visu-Control	V 12		578324	
	V 15		578328	
	V 18		578332	
	V 22		578334	
	V 28		578336	
	V 35		578604	
	V 12 S (PR-2B)	Mini Z8	574748	
	V 15 S (PR-2B)	Mini Z8	574752	
	V 18 S (PR-2B)	Mini Z8	574756	
	V 22 S (PR-2B)	Mini Z8	574758	
Seppelfricke VSH SudoPress Edelstahl Visu-Control	V 12		578324	
	V 15		578328	
	V 18		578332	
	V 22		578334	
	V 28		578336	
	V 35		578604	
	V 12 S (PR-2B)	Mini Z8	574748	
	V 15 S (PR-2B)	Mini Z8	574752	
	V 18 S (PR-2B)	Mini Z8	574756	
	V 22 S (PR-2B)	Mini Z8	574758	
Seppelfricke VSH SudoPress Kupfer Visu-Control	V 12		578324	
	V 15		578328	
	V 18		578332	
	V 22		578334	
	V 28		578336	
	V 35		578604	
	V 12 S (PR-2B)	Mini Z8	574748	
	V 15 S (PR-2B)	Mini Z8	574752	
	V 18 S (PR-2B)	Mini Z8	574756	
	V 22 S (PR-2B)	Mini Z8	574758	
Seppelfricke VSH SudoPress Kupfer Gas Visu-Control	V 12		578324	
	V 15		578328	
	V 18		578332	
	V 22		578334	
	V 28		578336	
	V 35		578604	
	V 12 S (PR-2B)	Mini Z8	574748	
	V 15 S (PR-2B)	Mini Z8	574752	
	V 18 S (PR-2B)	Mini Z8	574756	
	V 22 S (PR-2B)	Mini Z8	574758	
Seppelfricke VSH SudoPress Kupfer Solar Visu-Control	V 15		578328	
	V 18		578332	
	V 22		578334	
	V 15 S (PR-2B)	Mini Z8	574752	
	V 18 S (PR-2B)	Mini Z8	574756	
	V 22 S (PR-2B)	Mini Z8	574758	
	Seppelfricke VSH XPress C-Stahl	M 12		578310
		M 15		578312
M 18 ¹⁾			578314	
M 22			578316	
M 28 ¹⁾			578318	
M 35			578390	
M 12 S (PR-2B)		Mini Z8	574736	
M 15 S (PR-2B)		Mini Z8	574738	
SAVEUR REFLEX PEX Water	TH 16		578352	
	TH 20		578358	
	TH 25		578360	
	TH 32		578364	

Pressfitting systems for gas installations must only be pressed with REMS pressing tongs Mini/pressing rings which are highlighted in yellow.

Observe the national regulations. Read and observe the instructions for use and the installation instructions of the system provider/manufacturer.

- 1) Only pressing tongs from designation "108" (1st quarter of 2008), "208" (2nd quarter of 2008) etc. can be used. The designation is stamped on every pressing jaw.
- 2) For taking suitable pressing inserts.
- 3) Only pressing tongs from designation "117" (1st quarter of 2017), "217" (2nd quarter of 2017) etc. can be used. The designation is stamped on every pressing jaw.
- 4) For pipes of the EN technical standard. Observe the instructions for use of the system provider/manufacturer.
- 5) For pipes of the ASTM technical standard. Observe the instructions for use of the system provider/manufacturer.

The suitability of REMS pressing tools for pressfitting systems: Date 12.10.2022. For the updated situation regarding suitability status check our website: www.rems.de > Downloads > Product catalogues, brochures > REMS Catalogue.

See page 180 for adapter tongs. Pressing tongs for additional pressfitting systems on request.

REMS pressing tongs Mini REMS pressing rings

Accessories for REMS radial presses 22 kN

System	Pressing tongs / pressing rings	Driven by adapter tongs	Art.-No.	
Seppelfricke VSH XPress Edelstahl	M 15		578312	
	M 18 ¹⁾		578314	
	M 22		578316	
	M 28 ¹⁾		578318	
	M 35		578390	
	M 15 S (PR-2B)	Mini Z8	574738	
	M 18 S (PR-2B)	Mini Z8	574740	
	M 22 S (PR-2B)	Mini Z8	574742	
	M 28 S (PR-2B)	Mini Z8	574744	
	M 35 S (PR-2B)	Mini Z8	574746	
Seppelfricke VSH XPress Edelstahl gas	M 15		578312	
	M 18 ¹⁾		578314	
	M 22		578316	
	M 28 ¹⁾		578318	
	M 35		578390	
Seppelfricke VSH XPress Kupfer	M 12		578310	
	M 15		578312	
	M 18 ¹⁾		578314	
	M 22		578316	
	M 28 ¹⁾		578318	
	M 35		578390	
	M 12 S (PR-2B)	Mini Z8	574736	
	M 15 S (PR-2B)	Mini Z8	574738	
	M 18 S (PR-2B)	Mini Z8	574740	
	M 22 S (PR-2B)	Mini Z8	574742	
Seppelfricke VSH XPress Kupfer gas	M 15		578312	
	M 18 ¹⁾		578314	
	M 22		578316	
	M 28 ¹⁾		578318	
	M 35		578390	
	SESTA SESTA GAS	TH 14		578348
		TH 16		578352
		TH 20		578358
		TH 26		578362
		TH 32		578364
SESTA sistema multistrato	H 16		578400	
	H 20		578406	
	TH 14		578348	
	TH 16		578352	
	TH 18		578356	
	TH 20		578358	
	TH 26		578362	
	TH 40		578624	
	U 16		578374	
	U 20		578378	
SIGMA LI Premium	TH 16		578352	
	TH 20		578358	
	TH 25		578360	
	TH 32		578364	
	TH 16 S (PR-2B)	Mini Z8	574782	
	TH 20 S (PR-2B)	Mini Z8	574788	
	TH 32 S (PR-2B)	Mini Z8	574798	
	U 16		578374	
	U 20		578378	
	U 25		578380	
SLOVARM PEX-THERM	U 32		578382	
	U 16		578374	
	U 20		578378	
	H 26		578410	
	U 32		578382	
	H 16		578400	
	H 20		578406	
STANDARD HIDRAULICA MultiStandard	H 26		578410	
	H 32		578412	
	Rfz 16		578492	
	Rfz 20		578494	
	Rfz 25		578496	
	Rfz 32		578498	
	TH 16		578352	
	TH 20		578358	
	TH 25		578360	
	TH 32		578364	
steeltrade Presssystem Edelstahl Kontur M	TH 16 S (PR-2B)	Mini Z8	574782	
	TH 20 S (PR-2B)	Mini Z8	574788	
	TH 32 S (PR-2B)	Mini Z8	574798	
	U 16		578374	
	U 18		578376	
	U 20		578378	
	U 25		578380	
	U 32		578382	
	U 40		578386	
	STELBI Polikraft	M 15		578312
M 18 ¹⁾			578314	
M 22			578316	
M 28 ¹⁾			578318	
M 35			578390	
M 15 S (PR-2B)		Mini Z8	574738	
M 18 S (PR-2B)		Mini Z8	574740	
M 22 S (PR-2B)		Mini Z8	574742	
M 28 S (PR-2B)		Mini Z8	574744	
M 35 S (PR-2B)		Mini Z8	574746	
STELBI Polikraft	H 16		578400	
	H 20		578406	
	H 26		578410	
	TH 16		578352	
	TH 20		578358	
	TH 26		578362	
	TH 32		578364	
	TH 40		578624	
	TH 16 S (PR-2B)	Mini Z8	574782	
	TH 20 S (PR-2B)	Mini Z8	574788	
STELBI Polikraft	TH 26 S (PR-2B)	Mini Z8	574794	
	TH 32 S (PR-2B)	Mini Z8	574798	
	U 16		578374	
	U 20		578378	
	C 26		578392	

System	Pressing tongs / pressing rings	Driven by adapter tongs	Art.-No.
STELBI Stelgas	TH 16		578352
	TH 20		578358
	TH 26		578362
	TH 16 S (PR-2B)	Mini Z8	574782
	TH 20 S (PR-2B)	Mini Z8	574788
STH Westco COPPER PRESS	TH 26 S (PR-2B)	Mini Z8	574794
	M 15		578312
	M 22		578316
	M 28		578318
	M 35		578390
TDM BRASS Serie 1600	M 15 S (PR-2B)	Mini Z8	574738
	M 22 S (PR-2B)	Mini Z8	574742
	M 28 S (PR-2B)	Mini Z8	574744
	M 35 S (PR-2B)	Mini Z8	574746
	H 16		578400
	H 18		578404
	H 20		578406
	H 25		578408
	H 26		578410
	H 32		578412
TDM BRASS Serie 2600	TH 16		578352
	TH 18		578356
	TH 20		578358
	TH 25		578360
	TH 26		578362
	THL 32		578368
	TH 16 S (PR-2B)	Mini Z8	574782
	TH 20 S (PR-2B)	Mini Z8	574788
	TH 26 S (PR-2B)	Mini Z8	574794
	U 16		578374
TDM BRASS Serie 1700 gas	U 18		578376
	U 20		578378
	U 25		578380
	C 26		578392
	U 32		578382
	TH 16		578352
	TH 20		578358
	TH 26		578362
	THL 32		578368
	TH 16 S (PR-2B)	Mini Z8	574782
TermoConcept TC-PRESS	TH 20 S (PR-2B)	Mini Z8	574788
	TH 26 S (PR-2B)	Mini Z8	574794
THERMOLUTZ	Basic E01 ²⁾		578618
	H 14		578398
	H 16		578400
	TH 20		578358
	TH 20 S (PR-2B)	Mini Z8	574788
TE-SA TE-SA press serie 800	TH 14		578348
	TH 16		578352
	TH 18		578356
	TH 20		578358
	TH 26		578362
	TH 32		578364
	TH 40		578624
	TH 16 S (PR-2B)	Mini Z8	574782
	TH 20 S (PR-2B)	Mini Z8	574788
	TH 26 S (PR-2B)	Mini Z8	574794
THERMACOME ACOPEX ALU	TH 32 S (PR-2B)	Mini Z8	574798
	H 16		578400
	H 20		578406
	H 26		578410
	H 32		578412
	TH 16		578352
	TH 20		578358
	TH 26		578362
	TH 32		578364
	U 16		578374
TIEMME AL-COBRAPEX Serie 1650	U 20		578378
	U 32		578382
	TH 14		578348
	TH 16		578352
	TH 18		578356
	TH 20		578358
	TH 25		578360
	TH 26		578362
	THL 32		578368
	TH 40		578624
TDM BRASS Serie 1600	TH 16 S (PR-2B)	Mini Z8	574782
	TH 20 S (PR-2B)	Mini Z8	574788
	TH 26 S (PR-2B)	Mini Z8	574794
	U 16		578374
	U 20		578378

REMS pressing tongs Mini

REMS pressing rings

Accessories for REMS radial presses 22 kN

System	Pressing tongs / pressing rings	Driven by adapter tongs	Art.-No.
TIEMME Serie 1700 PE-X a pressare	RFz 12		578490
	RFz 16		578492
	RFz 20		578494
	RFz 25		578496
	RFz 32		578498
TIEMME TIEMME Gas	TH 16		578352
	TH 20		578358
	TH 26		578362
	THL 32		578368
	TH 16 S (PR-2B)	Mini Z8	574782
	TH 20 S (PR-2B)	Mini Z8	574788
TIGRE ALPEX GAS	TH 16		578352
	TH 20		578358
	TH 26		578362
	TH 32		578364
TKM Systemtechnik	TH 14		578348
	TH 16		578352
	TH 20		578358
	TH 26		578362
	TH 32		578364
	TH 40		578624
TRA MULTITRAPRESS	U 16		578374
	U 18		578376
	U 20		578378
	U 25		578380
	U 32		578382
	U 40		578386
TRA TRAPRESS	H 12		578396
	H 16		578400
	H 20		578406
	H 25		578408
	H 32		578412
	RFz 12		578490
	RFz 16		578492
	RFz 20		578494
	RFz 25		578496
	RFz 32		578498
Tradelink TradePex Crimp Water	K16/P18		578592
	K/20		578594
	K/25		578596
	K32		578598
	K1/40		578600
Tradelink TradePex Crimp Gas	K16/P18		578592
	K/20		578594
	K/25		578596
	K32		578598
	K1/40		578600
TUBIPLAST ITALY MULTILAYER PIPE	H 16		578400
	H 18		578404
	H 20		578406
	H 26		578410
	H 32		578412
	TH 16		578352
	TH 18		578356
	TH 20		578358
	TH 26		578362
	TH 32		578364
	TH 40		578624
	TH 16 S (PR-2B)	Mini Z8	574782
	TH 20 S (PR-2B)	Mini Z8	574788
	TH 26 S (PR-2B)	Mini Z8	574794
	TH 32 S (PR-2B)	Mini Z8	574798
	U 16		578374
	U 18		578376
	U 20		578378
	C 26		578392
	U 32		578382
TUBIPLAST ITALY MULTILAYER PIPE GAS SYSTEM	TH 16		578352
	TH 18		578356
	TH 20		578358
	TH 26		578362
	TH 32		578364
	TH 16 S (PR-2B)	Mini Z8	574782
	TH 20 S (PR-2B)	Mini Z8	574788
	TH 26 S (PR-2B)	Mini Z8	574794
	TH 32 S (PR-2B)	Mini Z8	574798
	TWEETOP	U 16	
U 20			578378
U 25			578380
U 32			578382
U 40			578386
U			
UNICAL AG MAX-MULTIPEX	U 16		578374
	U 20		578378
	H 26		578410
	C 26		578392
	U 32		578382

System	Pressing tongs / pressing rings	Driven by adapter tongs	Art.-No.
UNIDELTA DELTA PRESS	TH 16		578352
	TH 20		578358
	TH 26		578362
	TH 32		578364
	TH 40		578624
	TH 16 S (PR-2B)	Mini Z8	574782
	TH 20 S (PR-2B)	Mini Z8	574788
	TH 26 S (PR-2B)	Mini Z8	574794
	TH 32 S (PR-2B)	Mini Z8	574798
	H 16		578400
	H 20		578406
	H 26		578410
	H 32		578412
	U 16		578374
UNIDELTA DELTA PRESS GAS	TH 16		578352
	TH 20		578358
	TH 26		578362
	TH 32		578364
	TH 16 S (PR-2B)	Mini Z8	574782
	TH 20 S (PR-2B)	Mini Z8	574788
	TH 26 S (PR-2B)	Mini Z8	574794
	TH 32 S (PR-2B)	Mini Z8	574798
	H 16		578400
	H 20		578406
	H 26		578410
	H 32		578412
	U 16		578374
	U 20		578378
U 32		578382	
U 40		578386	
Uponor MLC	UP 14		578576
	UP 16		578578
	UP 18		578580
	UP 20		578582
	UP 25		578584
	UP 32		578586
Uponor MLC-D	UP 16		578578
	UP 20		578582
	UP 25		578584
	UP 32		578586
Uponor MLC-G	UP 20		578582
	UP 25		578584
	UP 32		578586
Uponor S-Press PLUS	UP 16		578578
	UP 20		578582
	UP 25		578584
	UP 32		578586
Uponor Uni Pipe PLUS	UP 16		578578
	UP 20		578582
	UP 25		578584
	UP 32		578586
V			
Valsir Bravopress	B 16		578468
	B 20		578472
	B 26		578474
	B 32		578476
	F 16		578456
	F 20		578460
	F 26		578462
	F 16 S (PR-2B)	Mini Z8	574728
	F 20 S (PR-2B)	Mini Z8	574730
	F 26 S (PR-2B)	Mini Z8	574732
	H 16		578400
	H 20		578406
	H 26		578410
	H 32		578412
	H 32 V		578602
	TH 16		578352
	TH 20		578358
TH 26		578362	
TH 32		578364	
U 16		578374	
U 20		578378	
C 26		578392	
U 32		578382	
Valsir PEXAL	H 14		578398
	H 16		578400
	H 20		578406
	H 26		578410
	H 32		578412
	H 32 V		578602
	TH 16		578352
	TH 20		578358
	TH 26		578362
	TH 32		578364
	U 16		578374
U 20		578378	
U 20		578378	
C 26		578392	
U 32		578382	

Pressfitting systems for gas installations must only be pressed with REMS pressing tongs Mini/pressing rings which are highlighted in yellow.

Observe the national regulations. Read and observe the instructions for use and the installation instructions of the system provider/manufacturer.

- 1) Only pressing tongs from designation "108" (1st quarter of 2008), "208" (2nd quarter of 2008) etc. can be used. The designation is stamped on every pressing jaw.
- 2) For taking suitable pressing inserts.
- 3) Only pressing tongs from designation "117" (1st quarter of 2017), "217" (2nd quarter of 2017) etc. can be used. The designation is stamped on every pressing jaw.
- 4) For pipes of the EN technical standard. Observe the instructions for use of the system provider/manufacturer.
- 5) For pipes of the ASTM technical standard. Observe the instructions for use of the system provider/manufacturer.

The suitability of REMS pressing tools for pressfitting systems: Date 12.10.2022. For the updated situation regarding suitability status check our website:

www.rems.de > Downloads > Product catalogues, brochures > REMS Catalogue.

See page 180 for adapter tongs. Pressing tongs for additional pressfitting systems on request.

REMS pressing tongs Mini REMS pressing rings

Accessories for REMS radial presses 22 kN

System	Pressing tongs / pressing rings	Driven by adapter tongs	Art.-No.
Van Marcke NV Tubipex	TH 16		578352
	TH 17		578354
	TH 20		578358
	TH 26		578362
	TH 32		578364
	TH 40		578624
	TH 16 S (PR-2B)	Mini Z8	574782
	TH 20 S (PR-2B)	Mini Z8	574788
	TH 26 S (PR-2B)	Mini Z8	574794
	TH 32 S (PR-2B)	Mini Z8	574798
Van Marcke NV Tubipress	M 12		578310
	M 15		578312
	M 18		578314
	M 22		578316
	M 28		578318
	M 35		578390
	M 12 S (PR-2B)	Mini Z8	574736
	M 15 S (PR-2B)	Mini Z8	574738
	M 18 S (PR-2B)	Mini Z8	574740
	M 22 S (PR-2B)	Mini Z8	574742
Variotherm System TH	TH 11,6		578344
	TH 16		578352
	TH 20		578358
	TH 16 S (PR-2B)	Mini Z8	574782
	TH 20 S (PR-2B)	Mini Z8	574788
	VESBO CARBON	M 15	
M 18			578314
M 22			578316
M 28			578318
M 35			578390
M 15 S (PR-2B)		Mini Z8	574738
M 18 S (PR-2B)		Mini Z8	574740
M 22 S (PR-2B)		Mini Z8	574742
M 28 S (PR-2B)		Mini Z8	574744
M 35 S (PR-2B)		Mini Z8	574746
VESBO INOX	M 15		578312
	M 18		578314
	M 22		578316
	M 28		578318
	M 35		578390
	M 15 S (PR-2B)	Mini Z8	574738
	M 18 S (PR-2B)	Mini Z8	574740
	M 22 S (PR-2B)	Mini Z8	574742
	M 28 S (PR-2B)	Mini Z8	574744
	M 35 S (PR-2B)	Mini Z8	574746
VESBO MULTIPRESS TH-U	TH 16		578352
	TH 20		578358
	TH 26		578362
	TH 32		578364
	TH 16 S (PR-2B)	Mini Z8	574782
	TH 20 S (PR-2B)	Mini Z8	574788
	TH 26 S (PR-2B)	Mini Z8	574794
	TH 32 S (PR-2B)	Mini Z8	574798
	U 16		578374
	U 20		578378
VESBO VPREMIUM	C 26		578392
	U 32		578382
	U 16		578374
	U 20		578378
	U 25		578380
Viega Fonterra	U 32		578382
	U 40		578386
	VX 12		578550
	VP 14/15		578480
	VP 16/17		578482
Viega MegaPress (ASTM) ³⁾	VP 20		578484
	VP 25		578486
Viega MegaPress 304 FKM (ASTM) ³⁾	VMP ½" (OD 21,3 mm)		578662
Viega MegaPress 316 FKM (ASTM) ³⁾	VMP ½" (OD 21,3 mm)		578662
Viega MegaPress 316 FKM (ASTM) ³⁾	VMP ½" (OD 21,3 mm)		578662
Viega MegaPress CuNi (ASTM) ³⁾	VMP ½" (OD 21,3 mm)		578662
Viega MegaPress FKM (ASTM) ³⁾	VMP ½" (OD 21,3 mm)		578662
Viega MegaPressG (ASTM) ³⁾	VMP ½" (OD 21,3 mm)		578662
Viega Megapress (EN) ⁴⁾	VMP ¾" (OD 17,2 mm)		578660
	VMP ½" (OD 21,3 mm)		578662
Viega Megapress S (EN) ⁴⁾	VMP ¾" (OD 17,2 mm)		578660
	VMP ½" (OD 21,3 mm)		578662
Viega Pexfit	VX 16		578552
	VX 20		578554
	VX 25		578556
	VX 16		578552
	VX 20		578554
Viega Pexfit Fosta G	VX 25		578556
	VX 16		578552
	VX 20		578554
Viega Prestabo	V 12		578324
	V 15		578328
	V 18		578332
	V 22		578334
	V 28		578336
	V 12 S (PR-2B)	Mini Z8	574748
	V 15 S (PR-2B)	Mini Z8	574752
	V 18 S (PR-2B)	Mini Z8	574756
	V 22 S (PR-2B)	Mini Z8	574758
	V 28 S (PR-2B)	Mini Z8	574760

System	Pressing tongs / pressing rings	Driven by adapter tongs	Art.-No.	
Viega Profipress	V 12		578324	
	V 15		578328	
	V 18		578332	
	V 22		578334	
	V 28		578336	
	V 35		578604	
	V 12 S (PR-2B)	Mini Z8	574748	
	V 15 S (PR-2B)	Mini Z8	574752	
	V 18 S (PR-2B)	Mini Z8	574756	
	V 22 S (PR-2B)	Mini Z8	574758	
	V 28 S (PR-2B)	Mini Z8	574760	
	V 35 S (PR-2B)	Mini Z8	574762	
	Viega Profipress G	V 12		578324
		V 15		578328
		V 18		578332
V 22			578334	
V 28			578336	
V 35			578604	
V 12 S (PR-2B)		Mini Z8	574748	
V 15 S (PR-2B)		Mini Z8	574752	
V 18 S (PR-2B)		Mini Z8	574756	
V 22 S (PR-2B)		Mini Z8	574758	
V 28 S (PR-2B)		Mini Z8	574760	
V 35 S (PR-2B)		Mini Z8	574762	
Viega Profipress S		V 12		578324
		V 15		578328
		V 18		578332
	V 22		578334	
	V 28		578336	
	V 35		578604	
	V 12 S (PR-2B)	Mini Z8	574748	
	V 15 S (PR-2B)	Mini Z8	574752	
	V 18 S (PR-2B)	Mini Z8	574756	
	V 22 S (PR-2B)	Mini Z8	574758	
	V 28 S (PR-2B)	Mini Z8	574760	
	V 35 S (PR-2B)	Mini Z8	574762	
	Viega Profipress Therm	V 12		578324
		V 15		578328
		V 18		578332
V 22			578334	
V 28			578336	
V 35			578604	
V 12 S (PR-2B)		Mini Z8	574748	
V 15 S (PR-2B)		Mini Z8	574752	
V 18 S (PR-2B)		Mini Z8	574756	
V 22 S (PR-2B)		Mini Z8	574758	
V 28 S (PR-2B)		Mini Z8	574760	
V 35 S (PR-2B)		Mini Z8	574762	
Viega ProPress (ASTM) ³⁾		VUS ½" (OD 15,9 mm)		578566
		VUS ¾" (OD 22,2 mm)		578568
		VUS 1" (OD 28,6 mm)		578570
	VUS 1¼" (OD 34,9 mm)		578606	
	Viega ProPress 304 FKM (ASTM) ³⁾	VUS ½" (OD 15,9 mm)		578566
VUS ¾" (OD 22,2 mm)			578568	
VUS 1" (OD 28,6 mm)			578570	
VUS 1¼" (OD 34,9 mm)			578606	
Viega ProPress 316 (ASTM) ³⁾		VUS ½" (OD 15,9 mm)		578566
	VUS ¾" (OD 22,2 mm)		578568	
	VUS 1" (OD 28,6 mm)		578570	
	VUS 1¼" (OD 34,9 mm)		578606	
	Viega ProPress WATER System AUS	VAU 15 (OD 12,7 mm)		578630
VAU 20 (OD 19,1 mm)			578632	
VAU 25 (OD 25,4 mm)			578634	
VAU 32 (OD 31,8 mm)			578636	
Viega ProPressG GAS System AUS	VAU 15 (OD 12,7 mm)		578630	
	VAU 20 (OD 19,1 mm)		578632	
	VAU 25 (OD 25,4 mm)		578634	
	VAU 32 (OD 31,8 mm)		578636	
Viega Raxinox	VRX 16		578640	
	VRX 20		578642	
Viega Raxofix	VRX 16		578640	
	VRX 20		578642	
	VRX 25		578644	
	VRX 32		578646	
Viega Sanfix	VP 16/17		578482	
	VP 20		578484	
	VP 25		578486	
	VP 32		578488	
Viega Sanfix Fosta	VP 16/17		578482	
	VP 20		578484	
	VP 25		578486	
	VP 32		578488	
Viega Sanpress	V 12		578324	
	V 15		578328	
	V 18		578332	
	V 22		578334	
	V 28		578336	
	V 35		578604	
	V 12 S (PR-2B)	Mini Z8	574748	
	V 15 S (PR-2B)	Mini Z8	574752	
	V 18 S (PR-2B)	Mini Z8	574756	
	V 22 S (PR-2B)	Mini Z8	574758	
Viega Sanpress Inox	V 28 S (PR-2B)	Mini Z8	574760	
	V 35 S (PR-2B)	Mini Z8	574762	
	V 15		578328	
	V 18		578332	
	V 22		578334	
	V 28		578336	
	V 35		578604	
	V 15 S (PR-2B)	Mini Z8	574752	
	V 18 S (PR-2B)	Mini Z8	574756	
	V 22 S (PR-2B)	Mini Z8	574758	
	V 28 S (PR-2B)	Mini Z8	574760	
	V 35 S (PR-2B)	Mini Z8	574762	

REMS pressing tongs Mini REMS pressing rings

Accessories for REMS radial presses 22 kN

System	Pressing tongs / pressing rings	Driven by adapter tongs	Art.-No.
Viega Sanpress Inox G	V 15		578328
	V 18		578332
	V 22		578334
	V 28		578336
	V 35		578604
	V 15 S (PR-2B)	Mini Z8	574752
	V 18 S (PR-2B)	Mini Z8	574756
	V 22 S (PR-2B)	Mini Z8	574758
	V 28 S (PR-2B)	Mini Z8	574760
V 35 S (PR-2B)	Mini Z8	574762	
Viega Smartpress	VX 16		578552
	VX 20		578554
	VX 25		578556
Viessmann	TH 14		578348
	TH 16		578352
	TH 20		578358
	TH 26		578362
	TH 32		578364
Vogel & Noot EASYTEC	TH 16		578352
	TH 20		578358
	TH 26		578362
	TH 32		578364
	TH 40		578624
	TH 16 S (PR-2B)	Mini Z8	574782
	TH 20 S (PR-2B)	Mini Z8	574788
	TH 26 S (PR-2B)	Mini Z8	574794
	TH 32 S (PR-2B)	Mini Z8	574798
VSH MultiPress	U 14		578372
	U 16		578374
	U 20		578378
	U 25		578380
	U 32		578382
	U 40		578386
	TH 14		578348
	TH 16		578352
	TH 20		578358
	TH 25		578360
	TH 32		578364
	TH 40		578624
	TH 16 S (PR-2B)	Mini Z8	574782
	TH 20 S (PR-2B)	Mini Z8	574788
	TH 32 S (PR-2B)	Mini Z8	574798
VSH MultiPress Gas	U 16		578374
	U 20		578378
	U 25		578380
	TH 16		578352
	TH 20		578358
VSH SudoPress Carbon	TH 16 S (PR-2B)	Mini Z8	574782
	TH 20 S (PR-2B)	Mini Z8	574788
	TH 32 S (PR-2B)	Mini Z8	574798
	V 12		578324
	V 15		578328
	V 18		578332
	V 22		578334
	V 28		578336
	V 35		578604
VSH SudoPress Copper	V 12 S (PR-2B)	Mini Z8	574748
	V 15 S (PR-2B)	Mini Z8	574752
	V 18 S (PR-2B)	Mini Z8	574756
	V 22 S (PR-2B)	Mini Z8	574758
	V 28 S (PR-2B)	Mini Z8	574760
	V 35 S (PR-2B)	Mini Z8	574762
	V 12		578324
	V 14		578326
	V 15		578328
	V 16		578330
VSH SudoPress Stainless	V 18		578332
	V 22		578334
	V 28		578336
	V 35		578604
	V 12 S (PR-2B)	Mini Z8	574748
	V 14 S (PR-2B)	Mini Z8	574800
	V 15 S (PR-2B)	Mini Z8	574752
	V 16 S (PR-2B)	Mini Z8	574802
	V 18 S (PR-2B)	Mini Z8	574756
	V 22 S (PR-2B)	Mini Z8	574758
	V 28 S (PR-2B)	Mini Z8	574760
	V 35 S (PR-2B)	Mini Z8	574762

System	Pressing tongs / pressing rings	Driven by adapter tongs	Art.-No.
VSH SudoPress Copper Gas	V 12		578324
	V 14		578326
	V 15		578328
	V 16		578330
	V 18		578332
	V 22		578334
	V 28		578336
	V 35		578604
	VSH SudoPress Stainless	V 15	
V 18			578332
V 22			578334
V 28			578336
V 35			578604
V 15 S (PR-2B)		Mini Z8	574752
VSH XPress Carbon	V 18 S (PR-2B)	Mini Z8	574756
	V 22 S (PR-2B)	Mini Z8	574758
	V 28 S (PR-2B)	Mini Z8	574760
	V 35 S (PR-2B)	Mini Z8	574762
	M 12		578310
VSH XPress Copper	M 15		578312
	M 18 ¹⁾		578314
	M 22		578316
	M 28 ¹⁾		578318
	M 35		578390
	M 12 S (PR-2B)	Mini Z8	574736
	M 15 S (PR-2B)	Mini Z8	574738
	M 18 S (PR-2B)	Mini Z8	574740
	M 22 S (PR-2B)	Mini Z8	574742
	M 28 S (PR-2B)	Mini Z8	574744
VSH XPress Copper GAS	M 35 S (PR-2B)	Mini Z8	574746
	M 12		578310
	M 15		578312
	M 18 ¹⁾		578314
	M 22		578316
	M 28 ¹⁾		578318
	M 35		578390
	M 15 S (PR-2B)	Mini Z8	574738
	M 18 S (PR-2B)	Mini Z8	574740
	M 22 S (PR-2B)	Mini Z8	574742
VSH XPress Stainless Gas	M 28 S (PR-2B)	Mini Z8	574744
	M 35 S (PR-2B)	Mini Z8	574746
	M 15		578312
	M 18 ¹⁾		578314
	M 22		578316
	M 28 ¹⁾		578318
	M 35		578390
	M 15 S (PR-2B)	Mini Z8	574738
	M 18 S (PR-2B)	Mini Z8	574740
	M 22 S (PR-2B)	Mini Z8	574742
Watts MTR Art press	M 28 S (PR-2B)	Mini Z8	574744
	M 35 S (PR-2B)	Mini Z8	574746
	TH 16		578352
	TH 20		578358
	TH 26		578362
WATTS RADIANT Watts WaterPEX	TH 32		578364
	US ¾"		578534
	US ½"		578536
WATTS RADIANT Watts	US ¾"		578538
	US ½"		578540
	US ¾"		578534
Watts RadiantPEX	US ½"		578536
	US 1"		578538

W

Pressfitting systems for gas installations must only be pressed with REMS pressing tongs Mini/pressing rings which are highlighted in yellow.

Observe the national regulations. Read and observe the instructions for use and the installation instructions of the system provider/manufacturer.

- 1) Only pressing tongs from designation "108" (1st quarter of 2008), "208" (2nd quarter of 2008) etc. can be used. The designation is stamped on every pressing jaw.
- 2) For taking suitable pressing inserts.
- 3) Only pressing tongs from designation "117" (1st quarter of 2017), "217" (2nd quarter of 2017) etc. can be used. The designation is stamped on every pressing jaw.
- 4) For pipes of the EN technical standard. Observe the instructions for use of the system provider/manufacturer.
- 5) For pipes of the ASTM technical standard. Observe the instructions for use of the system provider/manufacturer.

The suitability of REMS pressing tools for pressfitting systems: Date 12.10.2022. For the updated situation regarding suitability status check our website: www.rems.de > Downloads > Product catalogues, brochures > REMS Catalogue.

See page 180 for adapter tongs. Pressing tongs for additional pressfitting systems on request.

REMS pressing tongs Mini REMS pressing rings

Accessories for REMS radial presses 22 kN

System	Pressing tongs / pressing rings	Driven by adapter tongs	Art.-No.
WATTS	U 16 (1/2")		578374
RADIANT	U 20 (5/8")		578378
Watts	U 25 (3/4")		578380
RadiantPEX-AL	U 32 (1")		578382
Wavin	B 16		578468
Tigris K5/M5	B 20		578472
	B 32		578476
	H 16		578400
	H 20		578406
	H 25		578408
	H 32		578412
	TH 16		578352
	TH 20		578358
	TH 25		578360
	TH 32		578364
	TH 40		578624
	TH 16 S (PR-2B)	Mini Z8	574782
	TH 20 S (PR-2B)	Mini Z8	574788
	TH 32 S (PR-2B)	Mini Z8	574798
	U 16		578374
	U 20		578378
	U 25		578380
	U 32		578382
	U 40		578386
	UP 16		578578
	UP 20		578582
	UP 25		578584
	UP 32		578586
WEECON	M 15		578312
PRESS-C-Stahl	M 18		578314
	M 22		578316
	M 28		578318
	M 35		578390
	M 15 S (PR-2B)	Mini Z8	574738
	M 18 S (PR-2B)	Mini Z8	574740
	M 22 S (PR-2B)	Mini Z8	574742
	M 28 S (PR-2B)	Mini Z8	574744
	M 35 S (PR-2B)	Mini Z8	574746
WEECON	M 15		578312
PRESS-Edelstahl	M 18		578314
	M 22		578316
	M 28		578318
	M 35		578390
	M 15 S (PR-2B)	Mini Z8	574738
	M 18 S (PR-2B)	Mini Z8	574740
	M 22 S (PR-2B)	Mini Z8	574742
	M 28 S (PR-2B)	Mini Z8	574744
	M 35 S (PR-2B)	Mini Z8	574746
WEECON	V 15		578328
PRESS-Kupfer	V 18		578332
	V 22		578334
	V 28		578336
	V 35		578604
	V 15 S (PR-2B)	Mini Z8	574752
	V 18 S (PR-2B)	Mini Z8	574756
	V 22 S (PR-2B)	Mini Z8	574758
	V 28 S (PR-2B)	Mini Z8	574760
	V 35 S (PR-2B)	Mini Z8	574762
WEM	U 16		578374
WIELAND	TH 14		578348
cuprotherm	TH 16		578352
CTX	TH 18		578356
	TH 20		578358
	TH 26		578362

System	Pressing tongs / pressing rings	Driven by adapter tongs	Art.-No.
WKS-Press	TH 14		578348
	TH 16		578352
	TH 17		578354
	TH 20		578358
	TH 26		578362
	TH 32		578364
	TH 40		578624
WÜRTH	TH 16		578352
Würth	TH 20		578358
	TH 26		578362
	HE 32		578370
X			
XtraConnect	F 16		578456
	F 20		578460
	F 26		578462
	F 32		578464
	F 16 S (PR-2B)	Mini Z8	574728
	F 20 S (PR-2B)	Mini Z8	574730
	F 26 S (PR-2B)	Mini Z8	574732
	F 32 S (PR-2B)	Mini Z8	574734
	H 16		578400
	H 20		578406
	H 26		578410
	H 32		578412
	TH 16		578352
	TH 20		578358
	TH 26		578362
	TH 32		578364
	TH 16 S (PR-2B)	Mini Z8	574782
	TH 20 S (PR-2B)	Mini Z8	574788
	TH 26 S (PR-2B)	Mini Z8	574794
	TH 32 S (PR-2B)	Mini Z8	574798
	U 16		578374
	U 20		578378
(DN 26)	U 25		578380
	U 32		578382
	VP 16		578482
	VP 20		578484
	VP 32		578488
Y			
YX COPPER	Yz 16 UNI		578740
UNIPEX Water & Gas (AUS)	Yz 20 UNI		578742
	Yz 25 UNI		578744
	Yz 32 UNI		578746
Z			
ZEWOTHERM	TH 12		578346
Zewo Press Premium	TH 16		578352
	TH 17		578354
	TH 18		578356
	TH 20		578358
	TH 26		578362
	TH 32		578364
	TH 40		578624
ZEWOTHERM	TH 16		578352
Zewo Press PPSU	TH 20		578358
	TH 26		578362
	TH 32		578364
ZURN	US 3/8"		578534
INDUSTRIES	US 1/2"		578536
ZURN PEX	US 3/4"		578538
	US 1"		578540

Pressfitting systems for gas installations must only be pressed with REMS pressing tongs Mini/pressing rings which are highlighted in yellow.

Observe the national regulations. Read and observe the instructions for use and the installation instructions of the system provider/manufacturer.

- Only pressing tongs from designation "108" (1st quarter of 2008), "208" (2nd quarter of 2008) etc. can be used. The designation is stamped on every pressing jaw.
- For taking suitable pressing inserts.
- Only pressing tongs from designation "117" (1st quarter of 2017), "217" (2nd quarter of 2017) etc. can be used. The designation is stamped on every pressing jaw.
- For pipes of the EN technical standard. Observe the instructions for use of the system provider/manufacturer.
- For pipes of the ASTM technical standard. Observe the instructions for use of the system provider/manufacturer.

The suitability of REMS pressing tools for pressfitting systems: Date 12.10.2022. For the updated situation regarding suitability status check our website: www.rems.de > Downloads > Product catalogues, brochures > REMS Catalogue.

See page 180 for adapter tongs. Pressing tongs for additional pressfitting systems on request.

Accessories

Description	Art.-No.
Adapter tongs Mini Z8 for driving REMS pressing rings S (PR-2B)	574700
Steel case with insert for adapter tongs Mini Z8 and adapter tongs Z8 as well as 6 REMS pressing rings S (PR-2B)	574516
L-Boxx system case with inlay for Mini Z8 adapter tongs and Z8 adapter tongs as well as 14 REMS S pressing rings (PR-2B)	574704
Steel case with insert for 8 pressing tongs Mini/cropping tongs Mini and compartment for pipe cutter up to 42 mm	578295
L-Boxx system case with insert for 11 pressing tongs Mini and 6 pressing rings S (PR-2B)	578659



REMS cropping tongs Mini

Accessories for REMS radial presses 22 kN

High performance cropping tongs Mini in forged and specially hardened steel for cutting threaded rods.

Steel, stainless steel up to
hardness classification 4.8 (400 N/mm²) M 6 – M 10

REMS cropping tongs Mini – cuts in just 2 seconds!

Made of forged and specially hardened steel.

Reversible cropping inserts for double service life.

M cropping inserts with high precision thread contour machined on CNC machining centres for exact guiding of the threaded rod in the cutting process. Pliers parts, cropping inserts and specially machined and hardened cutting edges, made to fit exactly, for cutting without burr.

Threaded rod can be screwed into a threaded connection of the pipe clip or the nut without rework after cutting.

Cutting device in pliers design (**Patent EP 1 459 825, patent US 7,284,330**). Very compact design and low weight of the REMS Mini cropping tongs due to special arrangement of the cropping tongs connection (**Patent EP 1 952 948**). Recesses in the connecting plate for safe guidance of the connecting lugs for offset-free pressing (**Patent EP 2 347 862**).

Can be driven by all REMS radial presses 22 kN.

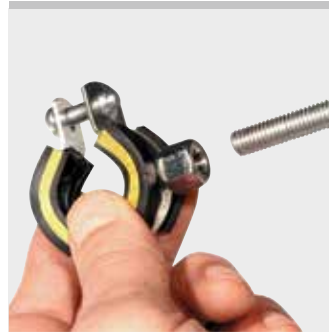
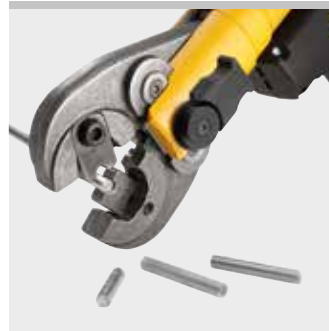

German Quality Product



Patent EP 1 952 948
Patent EP 1 459 825
Patent US 7,284,330
Patent EP 2 347 862

Supply format

REMS cropping tongs Mini. Cropping tongs with 1 pair of reversible cropping inserts for steel, stainless steel, M 6 – M 10. In a carton.

Description	for threaded rods	Art.-No.	
REMS cropping tongs Mini M 6	M 6	578620	
REMS cropping tongs Mini M 8	M 8	578621	
REMS cropping tongs Mini M 10	M 10	578622	

Accessories

Description	for threaded rods	Art.-No.	
Cropping inserts M 6 (pair)	M 6	571891	
Cropping inserts M 8 (pair)	M 8	571896	
Cropping inserts M 10 (pair)	M 10	571866	
Steel case with insert for 8 pressing tongs Mini/cropping tongs Mini and compartment for pipe cutter up to 42 mm		578295	



Universal, manual radial press for producing pipe pressing joints for common pressfitting systems.

Pressing joints with plastic and multi-layer composite tubes $\varnothing 10 - 26 \text{ mm}$
 $\varnothing \frac{3}{8} - 1''$

Complete range of REMS pressing tongs for all common pressfitting systems, see page 198 – 236.

REMS Eco-Press – universal up to $\varnothing 26 \text{ mm}$. Secure crimping in seconds.

System advantage

Only **one** type of pressing tongs for all REMS radial presses 32 kN and suitable radial presses of other makes with 32 kN thrust force.

All pressing tongs marked by a * have another connection and also fit the manual radial press REMS Eco-Press. Thus simple, inexpensive stocking.

Pressing tongs for all common systems

Complete assortment of REMS pressing tongs for all common pressfitting systems (page 198 – 236). Highly durable pressing tongs made of forged, tenacious, specially hardened special steel. Pressing contours of REMS pressing tongs are system-specific and correspond to the respective pressfitting system. Thus perfect system conformity, safe press jointing.

Design

Compact, handy, light. Drive unit with short tubular arms only 1.6 kg. Works anywhere, free-hand, overhead, in confined areas. Secure seating of pressing tongs through locking pins. Dividable tubular arms for individual adjustment of leverage to accommodate different force demands of different pressfitting systems.

Pressing operation

A perfect joint is achieved when pressing tongs close completely. Final-lock-positioning, the pressing jaws remain in a closed position until opening. This way, the perfect pressing joint (completely closed pressing jaws) can be observed.



Two connections for REMS Eco-Press manual radial press and REMS 32 kN radial presses.

German Quality Product



Info

Supply format

REMS Eco-Press drive unit. Manual radial press with final-lock-positioning for producing pressing joints of plastic and multi-layer composite tubes $\varnothing 10 - 26 \text{ mm}$, $\varnothing \frac{3}{8} - 1''$. For operating with REMS pressing tongs. With dividable tubular arms. In skin package.

	Art.-No.
	574000



Accessories

Description	Art.-No.
REMS pressing tongs , see page 198 – 236.	
REMS cropping tongs for threaded rods see page 239.	
Carrying bag for drive unit and for 3 pressing tongs	574436
Steel case with insert for drive unit and for 3 pressing tongs	574430



REMS Power-Press SE

Electric radial press 32 kN

Universal, handy electric tool for producing pipe pressing joints for all common pressfitting systems.

Pipe pressing joints \varnothing 10 – 108 (110) mm
 \varnothing $\frac{3}{8}$ – 4"

Complete range of REMS pressing tongs/pressing rings for all common pressfitting systems, see page 198 – 236.

REMS Power-Press SE – universal up to \varnothing 110 mm.
Secure crimping in seconds.
Automatic locking of pressing tongs.

System advantage

Only **one** type of pressing tongs/pressing rings for all REMS radial presses 32 kN and suitable radial presses of other makes with 32 kN thrust force.

All pressing tongs marked by a * have another connection and also fit the manual radial press REMS Eco-Press. Thus simple, inexpensive stocking.

Pressing tongs/pressing rings for all common systems

Complete assortment of REMS pressing tongs/pressing rings for all common pressfitting systems (page 198 – 236). Highly durable pressing tongs/pressing rings made of tenacious, specially hardened special steel. Pressing contours of REMS pressing tongs/pressing rings are system-specific and correspond to the respective pressfitting system. Thus perfect system conformity, safe press jointing. Adapter tongs required for driving the REMS (PR) pressing rings, see page 236.

Design

Compact, robust, job site-proven. Small in size, slender design, drive unit only 4.7 kg. Works anywhere, free-hand, overhead, in confined areas. Secure seating of pressing tongs/adapter tongs by automatic locking. Also suitable for other suitable makes of pressing tongs/pressing chains.

Pressing operation by touch-control

For reliable service, operating and functional safety. A perfect joint is achieved when pressing tongs close completely. The pressing tongs remain in a closed position until machine is switched and runs into reverse. The perfect pressing joint (completely closed pressing jaws) can be observed.

Drive

Enormous thrust and pressing force for fast and perfect press jointing. Thrust force 32 kN. Powerful electro-mechanical drive with proven universal motor, 450 W, maintenance-free gear with safety slipping clutch and in-feed system with machine screw spindle. Overload protection. Safety tip switch.



German Quality Product



Info



Supply format

REMS Power-Press SE Basic-Pack. Electric radial press 32 kN for producing pressing joints \varnothing 10 – 108 (110) mm, \varnothing $\frac{3}{8}$ – 4". For driving REMS pressing tongs/pressing rings and other suitable makes of pressing tongs/pressing rings. Pressing tongs seat with automatic locking. Electro-mechanical drive with proven universal motor 230 V or 110 V, 50 – 60 Hz, 450 W, maintenance-free gear with safety slipping clutch and in-feed system with machine screw spindle, overload protection, safety tip switch. In sturdy steel case.

	Art.-No.
	572111

Other voltages on request.

Accessories

Description	Art.-No.
REMS Power-Press SE Drive Unit	572101
REMS pressing tongs/pressing rings see page 198 – 236.	
REMS cropping tongs for threaded rods see page 239.	
REMS cable shear for electric cable see page 239.	
Steel case with insert	570280



REMS Power-Press

Electro-hydraulic radial press 32 kN
with switch-off signal

Universal, handy electric tool with switch-off signal for producing pipe pressing joints for all common pressfitting systems.

Pipe pressing joints \varnothing 10 – 108 (110) mm
 \varnothing $\frac{3}{8}$ – 4"

Complete range of REMS pressing tongs/
pressing rings for all common pressfitting systems,
see page 198 – 236.

REMS Power-Press – universal up to \varnothing 110 mm.

Secure crimping in seconds.

Automatic locking of pressing tongs.

System advantage

Only **one** type of pressing tongs/pressing rings for all REMS radial presses 32 kN and suitable radial presses of other makes with 32 kN thrust force.

All pressing connections marked by a * have another connection and also fit the manual radial press REMS Eco-Press. Thus simple, inexpensive stocking.

Pressing tongs/pressing rings for all common systems

Complete assortment of REMS pressing tongs/pressing rings for all common pressfitting systems (page 198 – 236). Highly durable pressing tongs/pressing rings made of tenacious, specially hardened special steel. Pressing contours of REMS pressing tongs/pressing rings are system-specific and correspond to the respective pressfitting system. Thus perfect system conformity, safe press jointing. Adapter tongs required for driving the REMS (PR) pressing rings, see page 236.

Design

Compact, robust, job site-proven. Small in size, slender design, drive unit only 4.7 kg. Works anywhere, free-hand, overhead, in confined areas. Ideal weight distribution for single handed operation. Ergonomically designed housing with recessed grip. Swivelling pressing tongs/adapter tongs seat. Secure seating of pressing tongs by automatic locking. Also suitable for other suitable makes of pressing tongs/pressing rings.

Pressing operation by touch-control

For reliable service, operating and functional safety. A perfect joint is achieved when pressing tongs close completely. Acoustic signal after successful completion of pressing operation. The pressing tongs remain in a closed position until reset button is pushed and releases. This way, the perfect pressing joint (completely closed pressing jaws) can be observed.

Drive

Enormous thrust and pressing force for fast and perfect press jointing. Thrust force 32 kN. Powerful electro-hydraulic drive with proven universal motor 450 W, robust planetary gear, eccentric reciprocating pump and compact high power hydraulic system. Safety tip switch.



Two connections for
REMS Eco-Press manual
radial press and REMS
32 kN radial presses.

German Quality Product



Supply format

REMS Power-Press Basic-Pack. Electro-hydraulic radial press 32 kN with switch-off signal for producing pressing joints \varnothing 10 – 108 (110) mm, \varnothing $\frac{3}{8}$ – 4". For driving REMS pressing tongs/pressing rings and other suitable makes of pressing tongs/pressing chains. Pressing tongs seat with automatic locking. Electro-hydraulic drive with proven universal motor 230 V or 110 V, 50 – 60 Hz, 450 W, robust planetary gear, eccentric reciprocating pump and compact high power hydraulic system. Safety tip switch.

Version	Art.-No.
In sturdy steel case.	577011
In L-Boxx system case.	577012

Other voltages on request.

Accessories

Description	Art.-No.
REMS Power-Press Drive Unit	577001
REMS pressing tongs/pressing rings see page 198 – 236.	
REMS cropping tongs for threaded rods see page 239.	
REMS cable shear for electric cable see page 239.	
Steel case with insert	570280
L-Boxx system case with inserts	571283



REMS Power-Press ACC

Electro-hydraulic radial press 32 kN with automatic retraction

Universal, handy electric tool with automatic circuit control for producing pipe pressing joints for all common pressfitting systems.

Pipe pressing joints \varnothing 10 – 108 (110) mm
 \varnothing $\frac{3}{8}$ – 4"

Complete range of REMS pressing tongs/pressing rings for all common pressfitting systems, see page 198 – 236.

REMS Power-Press ACC – universal up to \varnothing 110 mm. With automatic circuit control. Secure crimping in seconds. Automatic locking of pressing tongs.

System advantage

Only **one** type of pressing tongs/pressing rings for all REMS radial presses 32 kN and suitable radial presses of other makes with 32 kN thrust force.

All pressing tongs marked by a * have another connection and also fit the manual radial press REMS Eco-Press. Thus simple, inexpensive stocking.

Pressing tongs/pressing rings for all common systems

Complete assortment of REMS pressing tongs/pressing rings for all common pressfitting systems (page 198 – 236). Highly durable pressing tongs/pressing rings made of tenacious, specially hardened special steel. Pressing contours of REMS pressing tongs/pressing rings are system-specific and correspond to the respective pressfitting system. Thus perfect system conformity, safe press jointing. Adapter tongs required for driving the REMS (PR) pressing rings, see page 236.

Design

Compact, robust, job site-proven. Small in size, slender design, drive unit only 4.7 kg. Works anywhere, free-hand, overhead, in confined areas. Ideal weight distribution for single handed operation. Ergonomically designed housing with recessed grip. Swivelling pressing tongs/adapter tongs seat. Secure seating of pressing tongs by automatic locking. Also suitable for other suitable makes of pressing tongs/pressing rings.

Pressing operation by touch-control with ACC

For reliable service, operating and functional safety. Automatic retraction after completion of pressing operation (automatic circuit control).

Drive

Enormous thrust and pressing force for fast and perfect press jointing. Thrust force 32 kN. Powerful electro-hydraulic drive with proven universal motor 450 W, robust planetary gear, eccentric reciprocating pump and compact high power hydraulic system. Safety tip switch.



German Quality Product



Info

Supply format

REMS Power-Press ACC Basic-Pack. Electro-hydraulic radial press 32 kN with automatic retraction for producing pressing joints \varnothing 10 – 108 (110) mm, \varnothing $\frac{3}{8}$ – 4". For driving REMS pressing tongs/pressing rings and other suitable makes of pressing tongs/pressing rings. Pressing tongs seat with automatic locking. Electro-hydraulic drive with proven universal motor 230 V or 110 V, 50 – 60 Hz, 450 W, robust planetary gear, eccentric reciprocating pump and compact high power hydraulic system. Safety tip switch.

Version	Art.-No.
In sturdy steel case.	577010
In L-Boxx system case.	577013

Other voltages on request.



Accessories

Description	Art.-No.
REMS Power-Press ACC Drive Unit	577000
REMS pressing tongs/pressing rings see page 198 – 236.	
REMS cropping tongs for threaded rods see page 239.	
REMS cable shear for electric cable see page 239.	
Steel case with insert	570280
L-Boxx system case with inserts	571283



REMS Power-Press XL ACC

Electro-hydraulic radial press XL 32 kN
with automatic retraction

Universal, powerful power tool with automatic circuit control for making press joints of all common press fitting systems.

Pipe pressing joints \varnothing 10 – 108 (110) mm
 \varnothing $\frac{3}{8}$ – 4"

Complete range of REMS pressing tongs/pressing rings/
pressing rings XL for all common pressfitting systems,
see page 198 – 236.

REMS Power-Press XL ACC – universal up to \varnothing 110 mm.
Pressing of \varnothing 10 – 108 mm in just one action.
Ultra-fast, e.g. Geberit Mapress stainless steel \varnothing 108 mm
in only 15 seconds. With automatic circuit control.
Automatic locking of pressing tongs.

System advantage

Only **one** type of pressing tongs/pressing rings for all REMS radial presses 32 kN and suitable radial presses of other makes with 32 kN thrust force.

All pressing tongs marked by a * have another connection and also fit the manual radial press REMS Eco-Press. Thus simple, inexpensive stocking.

Pressing tongs/pressing rings for all common systems

Complete assortment of REMS pressing tongs/pressing rings/pressing rings XL for all common pressfitting systems (page 198 – 236). Highly durable pressing tongs/XL pressing rings made of tenacious, specially hardened special steel. Pressing contours of REMS pressing tongs/pressing rings/pressing rings XL are system-specific and correspond to the respective pressfitting system. Thus perfect system conformity, safe press jointing. Adapter tongs are required, as an accessory, for driving the REMS (PR) pressing rings.

Design

Compact, robust, job site-proven. Small in size, slender design, drive unit only 5.5 kg. Long working stroke for pressings in a single action, ideal for large dimensions. Ultra-fast, e.g. Geberit Mapress stainless steel \varnothing 108 mm in only 15 seconds. Ergonomically designed housing with soft grip and recessed handle. Swivelling pressing tongs/adapter tongs seat. Secure seating of pressing tongs by automatic locking. Also suitable for other suitable makes of pressing tongs/pressing rings. Adjustable hand guard.

Pressing operation by touch-control with ACC

For reliable service, operating and functional safety. Automatic retraction after completion of pressing operation (automatic circuit control).

Drive

Enormous thrust and pressing force for fast and perfect press jointing. Thrust force 32 kN. Powerful electro-hydraulic drive with proven universal motor 450 W, robust planetary gear, eccentric reciprocating pump and compact high power hydraulic system. Safety tip switch.



German Quality Product



Info

Supply format

REMS Power-Press XL ACC Basic-Pack. Electro-hydraulic radial press 32 kN with automatic retraction for producing pressing joints \varnothing 10 – 108 (110) mm, \varnothing $\frac{3}{8}$ – 4". For driving REMS pressing tongs/pressing rings/pressing rings XL and other suitable makes of pressing tongs/pressing rings. Pressing tongs seat with automatic locking. Electro-hydraulic drive with proven universal motor 230 V or 110 V, 50 – 60 Hz, 450 W, robust planetary gear, eccentric reciprocating pump and compact high power hydraulic system. Safety tip switch.

Version	Art.-No.
In transport case XL.	579010
In XL-Boxx system case.	579012

Other voltages on request.



Accessories

Description	Art.-No.
REMS Power-Press XL ACC drive Unit	579000
Adapter tongs Z6 XL for driving REMS pressing rings 64.0 – 108.0 XL (PR-3S), 2½ – 4" XL (PR-3S) with REMS Power-Press XL ACC	579120
Adapter tongs for other REMS pressing rings see page 236.	
REMS pressing tongs/pressing rings/pressing rings XL see page 198 – 236.	
REMS cropping tongs for threaded rods see page 239.	
REMS cable shear for electric cable see page 239.	
Transport case XL with inlays and practical carrying handles	579240
XL-Boxx system case with inserts	579601





REMS Akku-Press 14 V

Cordless radial press 32 kN with switch-off signal

Universal, handy electric tool with switch-off signal for producing pipe pressing joints for all common pressfitting systems. For battery and corded operation.

Pipe pressing joints \varnothing 10 – 108 (110) mm / \varnothing $\frac{3}{8}$ – 4

Complete range of REMS pressing tongs/pressing rings for all common pressfitting systems, see page 198 – 236.

REMS Akku-Press 14 V – universal up to \varnothing 110 mm.

Secure crimping in seconds.

Automatic locking of pressing tongs.

Li-Ion 14.4 V, 5.0 Ah battery for approx. 450 pressings

ViEGA Profipress DN 15 with one battery charge*.

System advantage

Only **one** type of pressing tongs/pressing rings for all REMS radial presses 32 kN and suitable radial presses of other makes with 32 kN thrust force.

All pressing tongs marked by a * have another connection and also fit the manual radial press REMS Eco-Press. Thus simple, inexpensive stocking.

Pressing tongs/pressing rings for all common systems

Complete assortment of REMS pressing tongs/pressing rings for all common pressfitting systems (page 198 – 236). Highly durable pressing tongs/pressing rings made of tenacious, specially hardened special steel. Pressing contours of REMS pressing tongs/pressing rings are system-specific and correspond to the respective pressfitting system. Thus perfect system conformity, safe press jointing. Adapter tongs required for driving the REMS (PR) pressing rings, see page 236.

Design

Compact, handy, light. Drive unit with battery only 4.3 kg. Works anywhere, free-hand, overhead, in confined areas. Optimum weight distribution for single-hand operation. Ergonomically shaped housing with recessed grip. LED work light for illuminating the work place. Swivelling pressing tongs seat. Secure seating of pressing tongs/adapter tongs by automatic locking. Also suitable for other suitable makes of pressing tongs/pressing rings.

Pressing operation by touch-control

For reliable service, operating and functional safety. A perfect joint is achieved when pressing tongs close completely. Acoustic signal after successful completion of pressing operation. The pressing tongs remain in a closed position until reset button is pushed and releases. This way, the perfect pressing joint (completely closed pressing jaws) can be observed.

Drive

Enormous thrust and pressing force for fast and perfect press jointing. Thrust force 32 kN. Powerful electro-hydraulic drive with powerful battery motor 14.4 V, 380 W output, robust planetary gear, eccentric reciprocating pump and compact high power hydraulic system. Safety tip switch.

Battery or mains operation

Li-Ion PLUS technology. Highly resistant Li-Ion 14.4 V battery with 5.0 Ah capacity, for long service life. Light and powerful. Li-Ion 14.4 V, 5.0 Ah battery for approx. 450 pressings ViEGA Profipress DN 15 with one battery charge*. Operating temperature range -10 to $+60$ °C. No memory effect for maximum battery power. Rapid charger 220–240 V or 110 V, 10.8–18 V, 65 W, for short charging times. Voltage supply 220–240 V/14.4 V, 33 A output, for mains operation instead of Li-Ion battery 14.4 V, as accessory.



German Quality Product

REMS TECHNOLOGY
LI-ION PLUS

International
Design Award

LED





Supply format

REMS Akku-Press 14 V Basic-Pack. Cordless radial press 32 kN with switch-off signal for producing pipe pressing joints \varnothing 10 – 108 (110) mm, \varnothing $\frac{3}{8}$ – 4". For driving REMS pressing tongs/pressing rings and other suitable makes of pressing tongs/pressing rings. Swivelling pressing tongs seat with automatic locking. Electro-hydraulic drive with powerful battery motor 14.4 V, 380 W, robust planetary gear, eccentric reciprocating pump and compact high power hydraulic system. Safety tip switch. LED work light. Battery Li-Ion 14.4 V, 5.0 Ah, rapid charger 220–240 V or 110 V, 50–60 Hz, 10.8–18 V, 65 W.

Version	Art.-No.
In sturdy steel case.	571013
In L-Boxx system case.	571020

Other voltages on request.

Accessories

Description	Art.-No.
REMS pressing tongs/pressing rings see page 198–236.	
REMS cropping tongs for threaded rods see page 239.	
REMS cable shear for electric cable see page 239.	
REMS Akku-Press 14 V drive unit, without battery	571003
Battery Li-Ion 14.4 V, 5.0 Ah	571555
Rapid charger 220–240 V, 50–60 Hz, 10.8–18 V, 65 W	571560
Voltage supply 220–240 V/14.4 V, 50–60 Hz, 33 A, for mains operation instead of battery Li-Ion 14.4 V.	571565
Steel case with inlay	571290
L-Boxx system case with inserts	571283



REMS Akku-Press 14 V ACC

Cordless radial press 32 kN with automatic circuit control

Universal, handy electric tool with automatic circuit control for producing pipe pressing joints for all common pressfitting systems. For battery and corded operation.

Pipe pressing joints \varnothing 10–108 (110) mm / \varnothing $\frac{3}{8}$ –4

Complete range of REMS pressing tongs/
pressing rings for all common pressfitting systems,
see page 198–236.

REMS Akku-Press 14 V ACC – universal up to \varnothing 110 mm. With automatic circuit control. Secure crimping in seconds. Automatic locking of pressing tongs. Li-Ion 14.4 V, 5.0 Ah battery for approx. 450 pressings Viega Profipress DN 15 with one battery charge*.

System advantage

Only **one** type of pressing tongs/pressing rings for all REMS radial presses 32 kN and suitable radial presses of other makes with 32 kN thrust force.

All pressing tongs marked by a * have another connection and also fit the manual radial press REMS Eco-Press. Thus simple, inexpensive stocking.

Pressing tongs/pressing rings for all common systems

Complete assortment of REMS pressing tongs/pressing rings for all common pressfitting systems (page 198–236). Highly durable pressing tongs/pressing rings made of tenacious, specially hardened special steel. Pressing contours of REMS pressing tongs/pressing rings are system-specific and correspond to the respective pressfitting system. Thus perfect system conformity, safe press jointing. Adapter tongs required for driving the REMS (PR) pressing rings, see page 236.

Design

Compact, handy, light. Drive unit with battery only 4.3 kg. Works anywhere, free-hand, overhead, in confined areas. Optimum weight distribution for single-hand operation. Ergonomically shaped housing with recessed grip. LED work light for illuminating the work place. Swivelling pressing tongs seat. Secure seating of pressing tongs/adapter tongs by automatic locking. Also suitable for other suitable makes of pressing tongs/pressing rings.

Pressing operation by touch-control with ACC

For reliable service, operating and functional safety. Automatic retraction after completion of pressing operation (automatic circuit control).

Drive

Enormous thrust and pressing force for fast and perfect press jointing. Thrust force 32 kN. Powerful electro-hydraulic drive with powerful battery motor 14.4 V, 380 W output, robust planetary gear, eccentric reciprocating pump and compact high power hydraulic system. Safety tip switch.

Battery or mains operation

Li-Ion PLUS technology. Highly resistant Li-Ion 14.4 V battery with 5.0 Ah capacity, for long service life. Light and powerful. Li-Ion 14.4 V, 5.0 Ah battery for approx. 450 pressings Viega Profipress DN 15 with one battery charge*. Operating temperature range –10 to +60 °C. No memory effect for maximum battery power. Rapid charger 220–240 V or 110 V, 10.8–18 V, 65 W, for short charging times. Voltage supply 220–240 V/14.4 V, 33 A output, for mains operation instead of Li-Ion battery 14.4 V, as accessory.



German Quality Product



Info



Supply format

REMS Akku-Press 14 V ACC Basic-Pack. Cordless radial press 32 kN with automatic circuit control for producing pipe pressing joints \varnothing 10–108 (110) mm, \varnothing $\frac{3}{8}$ –4". For driving REMS pressing tongs/pressing rings and other suitable makes of pressing tongs/pressing rings. Swivelling pressing tongs seat with automatic locking. Electro-hydraulic drive with powerful battery motor 14.4 V, 380 W, robust planetary gear, eccentric reciprocating pump and compact high power hydraulic system. Safety tip switch. LED work light. Battery Li-Ion 14.4 V, 5.0 Ah, rapid charger 220–240V or 110 V, 50–60 Hz, 10.8–18 V, 65 W.

Version	Art.-No.
In sturdy steel case.	571014
In L-Boxx system case.	571019

Other voltages on request.

Accessories

Description	Art.-No.
REMS pressing tongs/pressing rings see page 198–236.	
REMS cropping tongs for threaded rods see page 239.	
REMS cable shear for electric cable see page 239.	
REMS Akku-Press 14 V ACC drive unit, without battery	571004
Battery Li-Ion 14.4 V, 5.0 Ah	571555
Rapid charger 220–240 V, 50–60 Hz, 10.8–18 V, 65 W	571560
Voltage supply 220–240 V/14.4 V, 50–60 Hz, 33 A, for mains operation instead of battery Li-Ion 14.4 V.	571565
Steel case with inlay	571290
L-Boxx system case with inserts	571283



REMS Akku-Press 22V ACC

Cordless radial press 32 kN with automatic circuit control and pressure monitoring

Universal, handy electric tool with automatic circuit control and pressure monitoring for producing pipe pressing joints for all common pressfitting systems. Li-Ion 22V Technology. For battery and corded operation.

Pipe pressing joints \varnothing 10 – 108 (110) mm
 \varnothing $\frac{3}{8}$ – 4"

Complete range of REMS pressing tongs/pressing rings for all common pressfitting systems, see page 198 – 236.

REMS Akku-Press ACC – universal up to \varnothing 110 mm. With automatic circuit control and pressure monitoring. Anti-vibration system. Secure crimping in seconds. Automatic locking of pressing tongs. Li-Ion 21.6V, 2.5 Ah battery for approx. 200 pressings Viega Profipress DN 15 with one battery charge*.

System advantage

Only **one** type of pressing tongs/pressing rings for all REMS radial presses 32 kN and suitable radial presses of other makes with 32 kN thrust force.

All pressing tongs marked by a * have another connection and also fit the manual radial press REMS Eco-Press. Thus simple, inexpensive stocking.

Pressing tongs/pressing rings for all common systems

Complete assortment of REMS pressing tongs/pressing rings for all common pressfitting systems (page 198 – 236). Highly durable pressing tongs/pressing rings made of tenacious, specially hardened special steel. Pressing contours of REMS pressing tongs/pressing rings are system-specific and correspond to the respective pressfitting system. Thus perfect system conformity, safe press jointing. Adapter tongs required for driving the REMS (PR) pressing rings, see page 236.

Design

Compact, handy, super light. Drive unit with battery only 3.2 kg. Drive unit with pressing tongs V 15 only 35.5 cm long. Works anywhere, free-hand, overhead, also in particularly tight areas. Works anywhere, free-hand, overhead, in confined areas. Optimum weight distribution for single-hand operation. Drive unit with inserted pressing tongs can be put down on the battery ready to pick up. Ergonomically designed housing and soft grips. LED work light for illuminating the work place. Machine status check. Swivelling pressing tongs seat, rotation angle $> 360^\circ$. Secure seating of pressing tongs/adapter tongs by automatic locking. Also for other suitable makes of pressing tongs/pressing rings.

Pressure monitoring

Monitoring of the pressure during the pressing process. Pressure evaluation with coloured LED.

Anti-vibration system

Special drive technology with weight balancing and soft grips for low-vibration, fatigue-free pressing.

Pressing operation by touch-control with ACC

For reliable service, operating and functional safety. Automatic retraction after completion of pressing operation (automatic circuit control).

Drive

Enormous thrust and pressing force for fast and perfect press jointing. Thrust force 32 kN. Powerful electro-hydraulic drive with powerful battery motor 21.6V, 380 W output, robust planetary gear, eccentric reciprocating pump and compact high power hydraulic system. Safety tip switch.

Battery or mains operation

Li-Ion 22V Technology. Highly resistant Li-Ion 21.6V battery with 2.5, 4.4, 5.0 or 9.0 Ah capacity, for long service life. Light and powerful. Li-Ion 21.6V, 2.5 Ah batteries for approx. 200 pressings, 4.4 Ah for approx. 350 pressings, 5.0 Ah for approx. 400 pressings, 9.0 Ah for approx. 720 pressings Viega Profipress DN 15 with one battery charge*. Graduated charging status check by coloured LEDs. Operating temperature range – 10 to + 60 °C. No memory effect for maximum battery power. Rapid charger 100 – 240V, 90W. Rapid charger 100 – 240V, 290W, for shorter charging times, as accessory. Voltage supply 220 – 240V/21.6V, 15A output, for mains operation instead of Li-Ion battery 21.6V, as accessory.



German Quality Product



Info

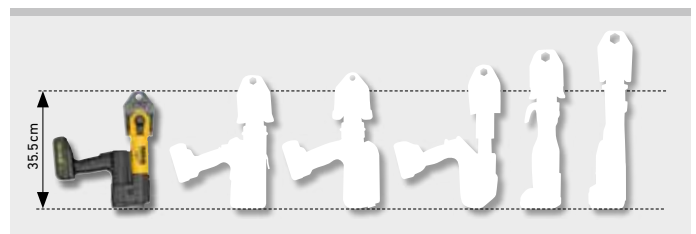

The little one amongst the big. Only 3.2 kg.



Supply format

REMS Akku-Press 22 V ACC Basic-Pack. Cordless radial press 32 kN with automatic circuit control and pressure monitoring for making press joints Ø 10–108 (110) mm, Ø 3/8–4". For driving REMS pressing tongs/pressing rings and other suitable makes of pressing tongs/pressing rings. Swivelling pressing tongs seat with automatic locking. Electro-hydraulic drive with powerful battery motor 21.6 V, 380 W, robust planetary gear, eccentric reciprocating pump and compact high power hydraulic system. Anti-vibration system. Safety tip switch. LED work light. Battery Li-Ion 21.6 V, 2.5 Ah, rapid charger 100–240 V, 50–60 Hz, 90 W.

Version	Art.-No.
In sturdy steel case.	576010
In L-Boxx system case.	576011

Other voltages on request.

Accessories

Description	Art.-No.
REMS pressing tongs/pressing rings see page 198–236.	
REMS cropping tongs for threaded rods see page 239.	
REMS cable shear for electric cable see page 239.	
REMS Akku-Press 22 V ACC drive unit, without battery	576000
Battery Li-Ion 21.6 V, 2.5 Ah	571571
Battery Li-Ion 21.6 V, 4.4 Ah	571574
Battery Li-Ion 21.6 V, 5.0 Ah	571581
Battery Li-Ion 21.6 V, 9.0 Ah	571583
Rapid charger 100–240 V, 50–60 Hz, 90 W	571585
Rapid charger 100–240 V, 50–60 Hz, 290 W	571587
Voltage supply 220–240 V/21.6 V, 50–60 Hz, 15 A, for mains operation instead of battery Li-Ion 21.6 V.	571567
Steel case with inlay	571290
L-Boxx system case with inserts	571283
REMS Lumen 2800 22 V, cordless LED flood light, see page 111	



REMS Akku-Press 22V ACC Connected

Cordless radial press 32 kN with Connected functionality via Wi-Fi radio standard and OLED display

Universal, handy electric tool with Connected functionality via Wi-Fi radio standard and OLED display for producing pipe pressing joints for all common pressfitting systems. Li-Ion 22V Technology. For battery and corded operation.

Pipe pressing joints Ø 10 – 108 (110) mm
Ø 3/8 – 4"

Complete range of REMS pressing tongs/pressing rings for all common pressfitting systems, see page 198 – 236.

REMS Akku-Press 22V ACC Connected – universal up to Ø 110 mm. With Connected functionality via Wi-Fi radio standard and OLED display. Selectable ACC drive mode. Pressure monitoring. Anti-vibration system. Automatic locking of pressing tongs. Electrically monitored closing position of the tong retaining bolt. Secure crimping in seconds. Voice recordings with voice recognition. Creating reports with texts and pictures. Geolocalisation of the pressing sites. Li-Ion 21.6V, 2.5 Ah battery for approx. 200 pressings. Viega Profipress DN 15 with one battery charge*.

System advantage

Only **one** type of pressing tongs/pressing rings for all REMS radial presses 32 kN and suitable radial presses of other makes with 32 kN thrust force.

All pressing tongs marked by a * have another connection and also fit the manual radial press REMS Eco-Press. Thus simple, inexpensive stocking.

Pressing tongs/pressing rings for all common systems

Complete assortment of REMS pressing tongs/pressing rings for all common pressfitting systems (page 198 – 236). Highly durable pressing tongs/pressing rings made of tenacious, specially hardened special steel. Pressing contours of REMS pressing tongs/pressing rings are system-specific and correspond to the respective pressfitting system. Thus perfect system conformity, safe press jointing. Adapter tongs required for driving the REMS (PR) pressing rings, see page 236.

Design

Compact, handy, super light. Drive unit with battery only 3.3 kg. Drive unit with pressing tongs V 15 only 36.3 cm long. Works anywhere, free-hand, overhead, also in particularly tight areas. Works anywhere, free-hand, overhead, in confined areas. Optimum weight distribution for single-hand operation. Drive unit with inserted pressing tongs can be put down on the battery ready to pick up. Ergonomically designed housing with strong carrying ring for a shoulder strap. Soft-grip surfaces. Two rows of LED work lights for illuminating the workplace as required, adjustable brightness in 4 stages and lighting time. Machine status check with charging state indication by 2-coloured green/red LED. Swivelling pressing tongs seat, rotation angle > 360°. Secure seating of pressing tongs/adapter tongs by automatic locking. Electrically monitored closing position of the tong retaining bolt. Also for other suitable makes of pressing tongs/pressing rings.

Connected functionality

REMS Akku-Press 22V ACC Connected offers various additional functionalities such as, for example: Recording of measuring/pressing data, creation of reports with your own company logo, display of error messages, configuration of the product (language, date, time, time zone, pressure unit, LED lighting time and LED brightness, standby time, ACC drive mode, information signal tones, etc.), set-up of usage bars (immediate bar or feedback interval as anti-theft, time and date ranges for barring times, limitation of the number of performable pressings), geolocalisation of the pressing sites, conversion of voice recordings into editable text, upload and save images of pressings, display of notices (annual inspection and periodic testing, new firmware version, battery state, etc.), download and installation of new firmware version.

Pressure monitoring

Monitoring and display of pressure and maximum pressure during the pressing process. Pressure analysis after the pressing process with result display in the OLED display and with coloured LEDs. Display of the pressure-time diagram of the performed pressing directly in the OLED display.

Voice recordings with voice recognition

A voice recording can be made and stored for every pressing with the microphone integrated into the drive unit. These can be converted into editable text and transferred to reports in the Service Portal.

Wi-Fi connection to the Cloud

REMS Akku-Press 22V ACC Connected sends collected data (measuring and pressing data, error messages, configuration of the product, voice recordings, etc.) to the Cloud after registration and with an existing Internet connection. The data are processed and stored there. The user can access these data, upload and store pictures of pressings, create reports with texts and pictures and change the drive unit settings through the REMS Service Portal. The changes are transferred back to the drive unit via an existing Internet connection.

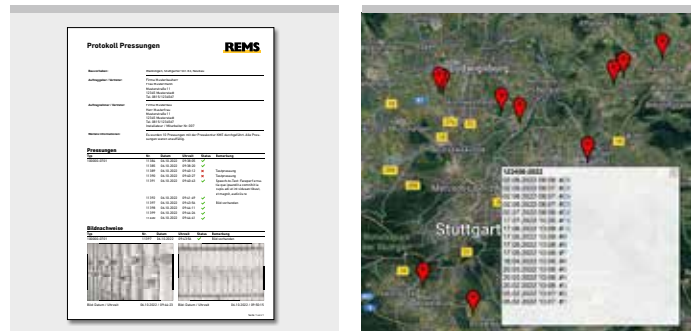

German Quality Product



REMS Akku-Press 22 V ACC Connected

Cordless radial press 32 kN with Connected functionality via Wi-Fi radio standard and OLED display

Selectable ACC drive mode

When ACC drive mode is switched on, the drive unit ends the pressing process automatically, emits an acoustic signal (clicking) and automatically returns (automatic circuit control). When ACC mode is switched off, the drive unit stops just before reaching the required pressure to be able to monitor complete closing of the pressing tongs, pressing ring and pressing segments better at the end of the pressing process. The pressing process must be continued by pressing the safety switch again. The drive unit ends the pressing process automatically, emits an acoustic signal (clicking) and automatically returns (automatic circuit control).

Drive

Enormous thrust and pressing force for fast and perfect press jointing. Thrust force 32 kN. High-performance, electro-hydraulic drive with powerful, brushless, maintenance free 21.6 V, 400 W battery motor, robust planetary gear, eccentric piston pump and compact high-performance hydraulic system. Safety switch.

Anti-vibration system

Special drive technology with weight balancing and soft grips for low-vibration, fatigue-free pressing.

Battery or mains operation

Li-Ion 22V Technology. Highly resistant Li-Ion 21.6V battery with 2.5, 4.4, 5.0 or 9.0Ah capacity, for long service life. Light and powerful. Li-Ion 21.6V, 2.5 Ah batteries for approx. 210 pressings, 4.4 Ah for approx. 370 pressings, 5.0 Ah for approx. 420 pressings, 9.0 Ah for approx. 750 pressings Viega Profipress DN 15 with one battery charge*. Graduated charging status check by coloured LEDs. Operating temperature range – 10 to + 60 °C. No memory effect for maximum battery power. Rapid charger 100–240V, 90W. Rapid charger 100–240V, 290W, for shorter charging times, as accessory. Voltage supply 220–240V/21.6V, 15A output, for mains operation instead of Li-Ion battery 21.6 V, as accessory.



The little one amongst the big. Only 3.3 kg.

Supply format

REMS Akku-Press 22 V ACC Connected Basic-Pack. Cordless radial press 32 kN with Connected functionality via Wi-Fi radio standard and OLED display, for making press joints \varnothing 10–108 (110) mm, \varnothing $\frac{3}{8}$ –4". For driving REMS pressing tongs/pressing rings and other suitable makes of pressing tongs/pressing rings. Swivelling pressing tongs seat with automatic locking. Electrically monitored closing position of the tong retaining bolt. Electro-hydraulic drive with powerful, brushless, maintenance free 21.6 V, 400W battery motor, robust planetary gear, eccentric piston pump and compact high-performance hydraulic system. Anti-vibration system. Safety tip switch. LED work lights. Battery Li-Ion 21.6 V, 2.5 Ah, rapid charger 100–240V, 50–60Hz, 90W.

Version	Art.-No.
In sturdy steel case.	576014
In L-Boxx system case.	576015

Other voltages on request.

Accessories

Description	Art.-No.
REMS pressing tongs/pressing rings see page 198–236.	
REMS cropping tongs for threaded rods see page 239.	
REMS cable shear for electric cable see page 239.	
REMS Akku-Press 22 V ACC Connected drive unit , without battery	576003
Battery Li-Ion 21.6 V, 2.5 Ah	571571
Battery Li-Ion 21.6 V, 4.4 Ah	571574
Battery Li-Ion 21.6 V, 5.0 Ah	571581
Battery Li-Ion 21.6 V, 9.0 Ah	571583
Rapid charger 100–240V, 50–60 Hz, 90W	571585
Rapid charger 100–240V, 50–60 Hz, 290W	571587
Voltage supply 220–240V/21.6V, 50–60 Hz, 15A , for mains operation instead of battery Li-Ion 21.6 V.	571567
Steel case with inlay	571290
L-Boxx system case with inserts	571283
REMS Lumen 2800 22V , cordless LED flood light, see page 111	



* Ambient temperature approx. 20°C. Wi-Fi disabled. LED work lights off.

REMS Akku-Press XL 45 kN 22 V ACC

Cordless radial press XL 45 kN
with automatic circuit control

Universal, powerful electric tool with automatic circuit control for producing XL pipe pressing joints for all common pressfitting systems. Thrust force 45 kN. Li-Ion 22V Technology. For battery and corded operation.

Pipe pressing joints XL	Ø 64 – 108 mm
	Ø 2½ – 4"

Complete range of REMS pressing rings XL for all common pressfitting systems, see page 198 – 236.

REMS Akku-Press XL 45 kN 22 V ACC – the powerful one with 45 kN thrust force. Pressing of Ø 64 – 108 mm in a single action. Anti-vibration system. Super fast, e.g. Geberit Mapress stainless steel Ø 108 mm in just 15 s. With automatic circuit control. Secure seating of adapter tongs by automatic locking.

Li-Ion 21.6 V, 5.0 Ah battery, for approx. 150 pressings Geberit Mapress stainless steel Ø 108.0 mm with one battery charge*.

Pressing rings XL for all common systems

Full range of REMS pressing rings XL for driving by REMS Akku-Press XL 45 kN 22 V ACC (page 198 – 236). Highly durable pressing rings XL made of tenacious, specially hardened special steel. Pressing contours of REMS pressing rings XL are system-specific and correspond to the respective pressfitting system. Thus perfect system conformity, safe press jointing.

Adapter tongs Z7 XL 45 kN

For driving REMS pressing rings XL by REMS Akku-Press XL 45 kN 22 V ACC adapter tongs Z7 XL 45 kN are required.

Design

Compact, robust, job site-proven. Small in size, slender design, drive unit with battery only 6.5 kg. Long working stroke for pressings in a single action. Super fast, e.g. Geberit Mapress stainless steel Ø 108 mm in just 15 s. Drive unit with inserted pressing tongs can be put down on the battery ready to pick up. Ergonomically designed housing and soft grips. LED work light for illuminating the work place. Machine status check. Swivelling pressing ring seat, rotation angle > 360°. Secure seating of adapter tongs by automatic locking.

Anti-vibration system

Special drive technology with weight balancing and soft grips for low-vibration, fatigue-free pressing.

Pressing operation by touch-control with ACC

For reliable service, operating and functional safety. Automatic retraction after completion of pressing operation (automatic circuit control).

Drive

Enormous thrust and pressing force for fast and perfect press jointing. Thrust force 45 kN. Powerful electro-hydraulic drive with powerful battery motor 21.6 V, 380 W output, robust planetary gear, eccentric dual-piston pump and compact high power hydraulic system. Safety tip switch.

Battery or mains operation

Li-Ion 22 V Technology. Highly resistant Li-Ion 21.6 V battery with 4.4, 5.0 or 9.0 Ah capacity, for long service life. Light and powerful. Li-Ion 21.6 V, 4.4 Ah batteries for approx. 130 pressings, 5.0 Ah batteries for approx. 150 pressings, 9.0 Ah for approx. 270 pressings Geberit Mapress stainless steel Ø 108.0 mm with one battery charge*. Graduated charging status check by coloured LEDs. Operating temperature range – 10 to + 60 °C. No memory effect for maximum battery power. Rapid charger 100 – 240 V, 90 W. Rapid charger 100 – 240 V, 290 W, for shorter charging times, as accessory. Voltage supply 220 – 240 V/21.6 V, 40 A output, for mains operation instead of Li-Ion battery 21.6 V, as accessory.



German Quality Product



Supply format

REMS Akku-Press XL 45 kN 22 V ACC Basic-Pack Z7. Cordless radial press 45 kN with automatic circuit control for making press joints XL Ø 64–108 mm, Ø 2½–4". For driving REMS pressing rings XL. Swivelling pressing ring seat with automatic locking. Electro-hydraulic drive with powerful battery motor 21.6 V, 380 W, robust planetary gear, eccentric dual-piston pump and compact high power hydraulic system. Anti-vibration system. Safety tip switch. LED work light. Battery Li-Ion 21.6 V, 5.0 Ah, rapid charger 100–240 V, 50–60 Hz, 90 W. Adapter tongs Z7 XL 45 kN. In XL-Boxx system case.

	Art.-No.
	579014

Other voltages on request.



Accessories

Description	Art.-No.
REMS Akku-Press XL 45 kN 22 V ACC drive unit, without battery	579001
Adapter tongs Z7 XL 45 kN for driving REMS pressing rings 64.0–108.0 XL (PR-3S), 2½–4" XL (PR-3S), 2½–4" XL (PR-3B) with REMS Akku-Press XL 45 kN 22 V ACC	579123

REMS pressing rings XL see page 198–236

Battery Li-Ion 21.6 V, 4.4 Ah	571574
Battery Li-Ion 21.6 V, 5.0 Ah	571581
Battery Li-Ion 21.6 V, 9.0 Ah	571583
Rapid charger 100–240 V, 50–60 Hz, 90 W	571585
Rapid charger 100–240 V, 50–60 Hz, 290 W	571587
Voltage supply 220–240 V/21.6 V, 50–60 Hz, 40 A, for mains operation instead of battery Li-Ion 21.6 V	571578
XL-Boxx system case with inserts	579601

REMS Lumen 2800 22 V, cordless LED flood light, see page 111



for all common pressfitting systems

**Select REMS pressing tongs/
REMS pressing rings yourself!**

Find the desired press fitting system in the table below and choose the size of pressing tongs/pressing rings that you require. Please note that pressfitting systems for gas installation may only be pressed with the pressing tongs/pressing rings which are highlighted in yellow in the table.

Highly durable pressing tongs/pressing rings made of tenacious, specially hardened special steel. Pressing contours of REMS pressing tongs/pressing rings are system-specific and correspond with the respective pressfitting system. Thus perfect system-conformity, safe press jointing. Pressing jaws of pressing tongs/pressing rings manufactured on CNC production centres ensure high-precision machining of pressing contour. Low production tolerances as a result.

Driven by REMS radial presses 32 kN and suitable radial presses of other makes with 32 kN thrust force or, if the system requires, by REMS Akku-Press XL 45 kN 22V ACC with 45 kN thrust force, see the table below. Adapter tongs (page 236) required for driving REMS (PR) pressing rings. All pressing tongs marked with * have an optional connection for manual drive through the radial press REMS Eco-Press.

Read and observe the instructions for use and the installation instructions of the system provider/manufacturer.

REMS pressing tongs (PZ-2B)

REMS pressing tongs (PZ-2B) with 2 swivellable monoblock pressing jaws. Most sold standard version. REMS ACz, Fz, RFz, RFlz, VMPz pressing tongs with teeth prevent formation of burr on the pressfitting (**Patent EP 2 027 971**).

REMS pressing tongs (PZ-4G)

REMS pressing tongs (PZ-4G) with two pivoted, parallel aligned pressing segments for linear pressing of midsize dimensions.

REMS pressing tongs (PZ-S)

REMS pressing tongs (S) with one fixed and two pivoted pressing segments, for midsize dimensions. REMS VMPz pressing tongs with teeth prevent formation of burr on the pressfitting.

REMS pressing rings (PR-3S)

REMS pressing ring (PR-3S) with 3 pressing segments, 2 swivel guided, for large dimension complex pressings. Ideal pressing through radially controlled movement of pressing segments. Adapter tongs required, see page 236.

REMS pressing rings (PR-3B)

REMS pressing rings (PR-3B) with 3 pressing segments for high quality, large dimension pressings Optimum pressing by radially controlled movement of the pressing segments. Adapter tongs required, see page 236. REMS VAUFz, VFz, VMPz, VUSFz pressing rings with teeth prevent formation of burr on the pressfitting.

REMS pressing ring (PR-2B)

REMS pressing ring (PR-2B) with 2 pressing jaws, for secure engagement of the pressing jaws in tight spaces, for midsize dimensions. Adapter tongs required for driving the REMS (PR-2B) pressing rings, see page 236.

REMS pressing ring S (PR-2B)

REMS pressing ring S (PR-2B), continuously swivellable, with 2 pressing jaws, for secure engagement of the pressing jaws in places of difficult access. Adapter tongs required for driving the REMS S (PR-2B) pressing rings, see page 236.

Traceability according to EN 1775:2007

REMS pressing tongs/pressing rings with pressing contour F, M, V, SA, B, RN and UP have worked a specific marking into the pressing contour which leaves a lasting impression on the pressed fitting after the pressing process. This enables the user to check again whether the most suitable pressing tongs or the suitable pressing ring have been used to make the pressfit connection even after the pressing process.

With this traceability REMS fulfils the recommendations of the European standard EN 1775:2007 for the installation of pressfitting systems for gas.

Confirmation of suitability

See page 237.

Hold-Harmless and Indemnification Agreement

See page 238.



Two connections for REMS Eco-Press manual radial press and REMS 32 kN radial presses.



German Quality Product



REMS pressing tongs (PZ-2B)



REMS pressing tongs (PZ-4G)



REMS pressing tongs (PZ-S)



REMS pressing rings (PR-3S)



REMS pressing rings (PR-3B)

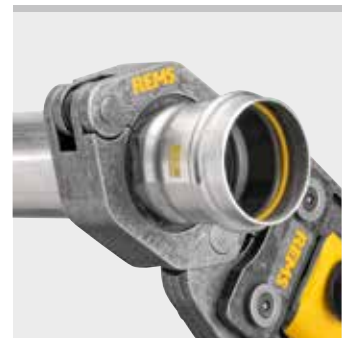

REMS pressing rings (PR-2B)



REMS pressing ring S (PR-2B), continuously swivellable

REMS pressing tongs
REMS pressing rings

Accessories for REMS radial presses (except for REMS Mini-Press) and suitable radial presses of other makes

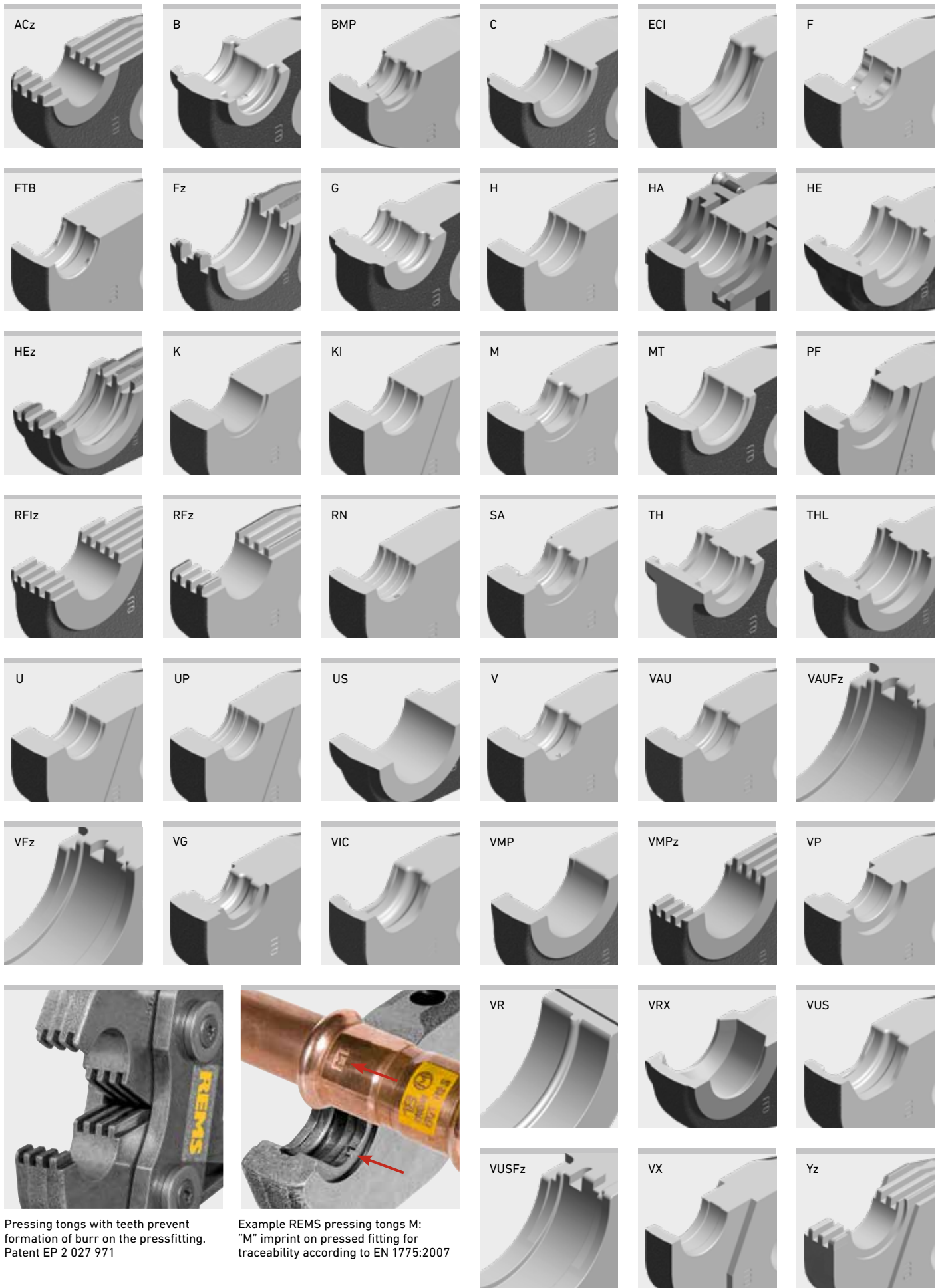

Pressing tongs with teeth prevent formation of burr on the pressfitting. Patent EP 2 027 971

Example REMS pressing tongs M: "M" imprint on pressed fitting for traceability according to EN 1775:2007

System	Pressing tongs / pressing rings	Driven by adapter tongs	Art.-No.	
A				
AC-FIX PRESS (Global Piping Systems)	H 12*		570300	
	H 16*		570320	
	H 20*		570350	
	H 25*		570360	
	H 32		570380	
	RFz 12*		571320	
	RFz 16*		571325	
	RFz 20*		571330	
	RFz 25		571335	
	RFz 32		571340	
	U 16*		570765	
	U 20*		570775	
	U 25*		570780	
	U 32		570785	
	VX 16*		571635	
	VX 20*		571640	
	AC-FIX PRESS DUO (Global Piping Systems)	RFz 16*		571325
RFz 20*			571330	
RFz 25			571335	
RFz 32			571340	
TH 16*			570460	
TH 20*			570470	
TH 25*			570495	
TH 26*			570475	
TH 32			570480	
TH 16 S (PR-2B)		Z8	574782	
TH 20 S (PR-2B)		Z8	574788	
TH 26 S (PR-2B)		Z8	574794	
TH 32 S (PR-2B)		Z8	574798	
U 16*			570765	
U 20*			570775	
U 25*			570780	
U 32			570785	
AC-FIX PRESS-MULTI (Global Piping Systems)	H 16*		570320	
	H 18*		570340	
	H 20*		570350	
	H 25*		570360	
	H 32		570380	
	RFz 16*		571325	
	RFz 20*		571330	
	RFz 25		571335	
	RFz 32		571340	
	U 16*		570765	
	U 18*		570770	
	U 20*		570775	
	U 25*		570780	
	U 32		570785	
	ACOME ACOPEX ALU	H 16*		570320
		H 20*		570350
		H 26*		570370
H 32			570380	
TH 16*			570460	
TH 20*			570470	
TH 26*			570475	
TH 32			570480	
U 16*			570765	
U 20*			570775	
U 32			570785	
ACOME MT		Acz 12*		572642
		Acz 16*		572644
	Acz 20*		572646	
	Acz 25		572648	
	AHLSELL A-press elförzinkad M	M 12		570100
M 15			570110	
M 18			570120	
M 22			570130	
M 28			570140	
M 35			570150	
M 42 (PR-3S)		Z2	572706	
M 54 (PR-3S)		Z2	572708	
M 76,1 XL (PR-3S)		Z6 XL ³⁾ / Z7 XL 45 kN ⁴⁾	579101	
M 88,9 G XL (PR-3S)		Z6 XL ³⁾ / Z7 XL 45 kN ⁴⁾	579110	
M 108,0 G XL (PR-3S)		Z6 XL ³⁾ / Z7 XL 45 kN ⁴⁾	579111	
M 12 S (PR-2B)		Z8	574736	
M 15 S (PR-2B)		Z8	574738	
M 18 S (PR-2B)		Z8	574740	
M 22 S (PR-2B)		Z8	574742	
M 28 S (PR-2B)		Z8	574744	
M 35 S (PR-2B)		Z8	574746	
AHLSELL A-press elförzinkad V	V 12		570107	
	V 15		570115	
	V 18		570125	
	V 22		570135	
	V 28		570145	
	V 35		570155	
	V 42		570165	
	V 54		570175	
	V 12 S (PR-2B)	Z8	574748	
	V 15 S (PR-2B)	Z8	574752	
	V 18 S (PR-2B)	Z8	574756	
	V 22 S (PR-2B)	Z8	574758	
	V 28 S (PR-2B)	Z8	574760	
	V 35 S (PR-2B)	Z8	574762	

System	Pressing tongs / pressing rings	Driven by adapter tongs	Art.-No.	
AHLSELL A-press koppar M	M 12		570100	
	M 15		570110	
	M 18		570120	
	M 22		570130	
	M 28		570140	
	M 35		570150	
	M 42 (PR-3S)	Z2	572706	
	M 54 (PR-3S)	Z2	572708	
	M 76,1 XL (PR-3S)	Z6 XL ³⁾ / Z7 XL 45 kN ⁴⁾	579101	
	M 88,9 G XL (PR-3S)	Z6 XL ³⁾ / Z7 XL 45 kN ⁴⁾	579110	
	M 108,0 G XL (PR-3S)	Z6 XL ³⁾ / Z7 XL 45 kN ⁴⁾	579111	
	M 15 S (PR-2B)	Z8	574738	
	M 18 S (PR-2B)	Z8	574740	
	M 22 S (PR-2B)	Z8	574742	
	M 28 S (PR-2B)	Z8	574744	
	M 35 S (PR-2B)	Z8	574746	
	AHLSELL A-press koppar V	V 12		570107
V 15			570115	
V 18			570125	
V 22			570135	
V 28			570145	
V 35			570155	
V 42			570165	
V 54			570175	
V 12 S (PR-2B)		Z8	574748	
V 15 S (PR-2B)		Z8	574752	
V 18 S (PR-2B)		Z8	574756	
V 22 S (PR-2B)		Z8	574758	
V 28 S (PR-2B)		Z8	574760	
V 35 S (PR-2B)		Z8	574762	
AHLSELL A-press rostfritt		M 15		570110
		M 18		570120
		M 22		570130
	M 28		570140	
	M 35		570150	
	M 42 (PR-3S)	Z2	572706	
	M 54 (PR-3S)	Z2	572708	
	M 76,1 XL (PR-3S)	Z6 XL ³⁾ / Z7 XL 45 kN ⁴⁾	579101	
	M 88,9 G XL (PR-3S)	Z6 XL ³⁾ / Z7 XL 45 kN ⁴⁾	579110	
	M 108,0 G XL (PR-3S)	Z6 XL ³⁾ / Z7 XL 45 kN ⁴⁾	579111	
	M 15 S (PR-2B)	Z8	574738	
	M 18 S (PR-2B)	Z8	574740	
	M 22 S (PR-2B)	Z8	574742	
	M 28 S (PR-2B)	Z8	574744	
	M 35 S (PR-2B)	Z8	574746	
	AIRBEL PRESSCLIM	M 15		570110
		M 18		570120
M 22			570130	
M 28			570140	
M 35			570150	
M 42 (PR-3S)		Z2	572706	
M 54 (PR-3S)		Z2	572708	
M 76,1 XL (PR-3S)		Z6 XL ³⁾ / Z7 XL 45 kN ⁴⁾	579101	
M 88,9 G XL (PR-3S)		Z6 XL ³⁾ / Z7 XL 45 kN ⁴⁾	579110	
M 108,0 G XL (PR-3S)		Z6 XL ³⁾ / Z7 XL 45 kN ⁴⁾	579111	
M 15 S (PR-2B)		Z8	574738	
M 18 S (PR-2B)		Z8	574740	
M 22 S (PR-2B)		Z8	574742	
M 28 S (PR-2B)		Z8	574744	
M 35 S (PR-2B)		Z8	574746	
AIRBEL SERTINOX		M 15		570110
		M 18		570120
	M 22		570130	
	M 28		570140	
	M 35		570150	
	M 42 (PR-3S)	Z2	572706	
	M 54 (PR-3S)	Z2	572708	
	M 76,1 XL (PR-3S)	Z6 XL ³⁾ / Z7 XL 45 kN ⁴⁾	579101	
	M 88,9 G XL (PR-3S)	Z6 XL ³⁾ / Z7 XL 45 kN ⁴⁾	579110	
	M 108,0 G XL (PR-3S)	Z6 XL ³⁾ / Z7 XL 45 kN ⁴⁾	579111	
	M 15 S (PR-2B)	Z8	574738	
	M 18 S (PR-2B)	Z8	574740	
	M 22 S (PR-2B)	Z8	574742	
	M 28 S (PR-2B)	Z8	574744	
	M 35 S (PR-2B)	Z8	574746	
	ALB Sistema Multicapa	TH 16*		570460
		TH 18*		570465
TH 20*			570470	
TH 26*			570475	
TH 32			570480	
TH 40			570485	
TH 50 (PZ-S)			572400	
TH 63 (PZ-S)			572405	
TH 16 S (PR-2B)		Z8	574782	
TH 20 S (PR-2B)		Z8	574788	
TH 26 S (PR-2B)		Z8	574794	
TH 32 S (PR-2B)		Z8	574798	
H 16*			570320	
H 18*			570340	
H 20*			570350	
H 26*			570370	
H 32			570380	
H 40 (PZ-46)		570390		
U 16*		570765		
U 18*		570770		
U 20*		570775		
C 26*		570750		
U 32		570785		
U 40		570790		

REMS pressing tongs REMS pressing rings

Accessories for REMS radial presses (except for REMS Mini-Press) and suitable radial presses of other makes

System	Pressing tongs/ pressing rings	Driven by adapter tongs	Art.-No.
ALB Sistema Multicapa Gas	TH 16*		570460
	TH 20*		570470
	TH 26*		570475
	TH 32		570480
	TH 16 S (PR-2B)	Z8	574782
	TH 20 S (PR-2B)	Z8	574788
	TH 26 S (PR-2B)	Z8	574794
	TH 32 S (PR-2B)	Z8	574798
	H 16*		570320
	H 20*		570350
	H 26*		570370
	H 32		570380
	U 16*		570765
	U 20*		570775
	C 26*		570750
U 32		570785	
ALTECH Altech	RFz 12*		571320
	RFz 16*		571325
	RFz 20*		571330
	RFz 25		571335
APE MULTYGAS Serie AP Gas	TH 16*		570460
	TH 20*		570470
	TH 26*		570475
	TH 32		570480
	TH 16 S (PR-2B)	Z8	574782
	TH 20 S (PR-2B)	Z8	574788
	TH 26 S (PR-2B)	Z8	574794
TH 32 S (PR-2B)	Z8	574798	
APE Serie AP	B 16*		570850
	B 20*		570860
	B 26		570870
	B 32		570880
	H 16*		570320
	H 20*		570350
	H 26*		570370
	H 32		570380
	TH 16*		570460
	TH 18*		570465
	TH 20*		570470
	TH 26*		570475
	TH 32		570480
	TH 16 S (PR-2B)	Z8	574782
	TH 20 S (PR-2B)	Z8	574788
	TH 26 S (PR-2B)	Z8	574794
	TH 32 S (PR-2B)	Z8	574798
	U 16*		570765
	U 20*		570775
	APE Serie APL	H 16*	
H 18*			570340
H 20*			570350
H 26*			570370
H 32			570380
TH 16*			570460
TH 18*			570465
TH 20*			570470
TH 26*			570475
TH 32			570480
TH 40			570485
TH 50 (PZ-S)			572400
TH 63 (PZ-S)			572405
TH 16 S (PR-2B)		Z8	574782
TH 20 S (PR-2B)		Z8	574788
TH 26 S (PR-2B)		Z8	574794
TH 32 S (PR-2B)		Z8	574798
U 16*		570765	
U 18*		570770	
U 20*		570775	

System	Pressing tongs/ pressing rings	Driven by adapter tongs	Art.-No.
AQUATECHNIK Press-fitting metal	H 16*		570320
	H 20*		570350
	H 26*		570370
	H 32		570380
	TH 16*		570460
	TH 20*		570470
	TH 26*		570475
	TH 32		570480
	TH 40		570485
	TH 50 (PZ-S)		572400
	TH 63 (PZ-S)		572405
	TH 16 S (PR-2B)	Z8	574782
	TH 20 S (PR-2B)	Z8	574788
	TH 26 S (PR-2B)	Z8	574794
	TH 32 S (PR-2B)	Z8	574798
U 16*		570765	
U 20*		570775	
C 26*		570750	
U 32		570785	
AQUATECHNIK Universal	B 16*		570850
	B 20*		570860
	B 26		570870
	B 32		570880
	F 16*		570717
	F 20*		570727
	F 26*		570730
	F 32		570735
	F 16 S (PR-2B)	Z8	574728
	F 20 S (PR-2B)	Z8	574730
	F 26 S (PR-2B)	Z8	574732
	F 32 S (PR-2B)	Z8	574734
	H 16*		570320
	H 20*		570350
	H 26*		570370
H 32		570380	
TH 16*		570460	
TH 20*		570470	
TH 26*		570475	
TH 32		570480	
TH 16 S (PR-2B)	Z8	574782	
TH 20 S (PR-2B)	Z8	574788	
TH 26 S (PR-2B)	Z8	574794	
TH 32 S (PR-2B)	Z8	574798	
U 16*		570765	
U 20*		570775	
C 26*		570750	
U 32		570785	
ARKA DUROsystem	H 16*		570320
	H 20*		570350
	H 25*		570360
	H 26*		570370
	H 32		570380
	TH 16*		570460
	TH 20*		570470
	TH 25*		570495
	TH 26*		570475
	TH 32		570480
	TH 16 S (PR-2B)	Z8	574782
	TH 20 S (PR-2B)	Z8	574788
	TH 26 S (PR-2B)	Z8	574794
	TH 32 S (PR-2B)	Z8	574798
	U 16*		570765
U 20*		570775	
Aschl NIR	M 15		570110
	M 18		570120
	M 22		570130
	M 28		570140
	M 35		570150
	M 42 (PR-3S)	Z2	572706
	M 54 (PR-3S)	Z2	572708
	M 76,1 XL (PR-3S)	Z6 XL ²⁾ / Z7 XL 45 kN ⁴⁾	579101
	M 88,9 G XL (PR-3S)	Z6 XL ²⁾ / Z7 XL 45 kN ⁴⁾	579110
	M 108,0 G XL (PR-3S)	Z6 XL ²⁾ / Z7 XL 45 kN ⁴⁾	579111
	M 15 S (PR-2B)	Z8	574738
	M 18 S (PR-2B)	Z8	574740
	M 22 S (PR-2B)	Z8	574742
	M 28 S (PR-2B)	Z8	574744
	M 35 S (PR-2B)	Z8	574746

Pressfitting systems for gas installations must only be pressed with pressing tongs/pressing rings which are highlighted in yellow.

Observe the national regulations. Read and observe the instructions for use and the installation instructions of the system provider/manufacturer.

* These pressing tongs also fit the manual radial press REMS Eco-Press. Observe the national regulations.

¹⁾ Only pressing tongs from designation "108" (1st quarter of 2008), "208" (2nd quarter of 2008) etc. can be used. The designation is stamped on every pressing jaw.

²⁾ For this pressfitting system producing a pressing joint with manual radial presses is not permitted.

³⁾ Driven by REMS Power-Press XL ACC.

⁴⁾ Driven by REMS Akku-Press XL 45 kN 22 V ACC.

⁵⁾ For taking suitable pressing inserts.

⁶⁾ Press fittings made of red bronze (Sanpress XL) must be pressed with pressing rings with press contour VR, copper fittings (Profipress XL, Profipress G XL), carbon steel (Prestabo XL) and stainless steel fittings (Sanpress Inox XL, Sanpress Inox G XL) with pressing rings with press contour VF.

⁷⁾ Use pressing rings labelled "M 88.9 G" or "M 108 G" on the three pressing segments for gas installations.

⁸⁾ For making press joints for operating pressure ≤ PN 10.

⁹⁾ For pipes of the EN technical standard. Observe the instructions for use of the system provider/manufacturer.

¹⁰⁾ For pipes of the ASTM technical standard. Observe the instructions for use of the system provider/manufacturer.

The suitability of REMS pressing tools for pressfitting systems: Date 12.10.2022. For the updated situation regarding suitability status check our website:

www.rems.de > Downloads > Product catalogues, brochures > REMS Catalogue.

See page 236 for adapter tongs. Pressing tongs/pressing rings for additional pressfitting systems on request.

REMS pressing tongs

REMS pressing rings

Accessories for REMS radial presses (except for REMS Mini-Press) and suitable radial presses of other makes

System	Pressing tongs / pressing rings	Driven by adapter tongs	Art.-No.
ASSOTHERM IPC-RAC Carbon Steel	M 15		570110
	M 18		570120
	M 22		570130
	M 28		570140
	M 35		570150
	M 42 (PZ-4G)		570160
	M 54 (PZ-4G)		570170
	M 42 (PR-3S)	Z2	572706
	M 54 (PR-3S)	Z2	572708
	M 76,1 XL (PR-3S)	Z6 XL ³⁾ / Z7 XL 45 kN ⁴⁾	579101
	M 88,9 G XL (PR-3S)	Z6 XL ³⁾ / Z7 XL 45 kN ⁴⁾	579110
	M 108,0 G XL (PR-3S)	Z6 XL ³⁾ / Z7 XL 45 kN ⁴⁾	579111
	M 15 S (PR-2B)	Z8	574738
	M 18 S (PR-2B)	Z8	574740
	M 22 S (PR-2B)	Z8	574742
	M 28 S (PR-2B)	Z8	574744
	M 35 S (PR-2B)	Z8	574746
ASSOTHERM IPI-RAX Inox	M 15		570110
	M 18		570120
	M 22		570130
	M 28		570140
	M 35		570150
	M 42 (PZ-4G)		570160
	M 54 (PZ-4G)		570170
	M 42 (PR-3S)	Z2	572706
	M 54 (PR-3S)	Z2	572708
	M 76,1 XL (PR-3S)	Z6 XL ³⁾ / Z7 XL 45 kN ⁴⁾	579101
	M 88,9 G XL (PR-3S)	Z6 XL ³⁾ / Z7 XL 45 kN ⁴⁾	579110
	M 108,0 G XL (PR-3S)	Z6 XL ³⁾ / Z7 XL 45 kN ⁴⁾	579111
	M 15 S (PR-2B)	Z8	574738
	M 18 S (PR-2B)	Z8	574740
	M 22 S (PR-2B)	Z8	574742
	M 28 S (PR-2B)	Z8	574744
	M 35 S (PR-2B)	Z8	574746
ASSOTHERM IPI-RAX Inox Gas	M 15		570110
	M 18		570120
	M 22		570130
	M 28		570140
	M 35		570150
	M 42 (PZ-4G)		570160
	M 54 (PZ-4G)		570170
	M 42 (PR-3S)	Z2	572706
	M 54 (PR-3S)	Z2	572708
	M 76,1 XL (PR-3S)	Z7 XL 45 kN ⁴⁾	579101
	M 88,9 G XL (PR-3S) ⁷⁾	Z7 XL 45 kN ⁴⁾	579110
	M 108,0 G XL (PR-3S) ⁷⁾	Z7 XL 45 kN ⁴⁾	579111
	M 15 S (PR-2B)	Z8	574738
	M 18 S (PR-2B)	Z8	574740
	M 22 S (PR-2B)	Z8	574742
	M 28 S (PR-2B)	Z8	574744
	M 35 S (PR-2B)	Z8	574746
ASSOTHERM IPM-Multistrato	H 16*		570320
	H 20*		570350
	H 26*		570370
	H 32		570380
	TH 16*		570460
	TH 20*		570470
	TH 26*		570475
	TH 32		570480
	THL 32		570487
	TH 40		570485
	TH 50 (PZ-S)		572400
	TH 63 (PZ-S)		572405
	TH 16 S (PR-2B)	Z8	574782
	TH 20 S (PR-2B)	Z8	574788
	TH 26 S (PR-2B)	Z8	574794
	TH 32 S (PR-2B)	Z8	574798
	U 16*		570765
U 20*		570775	
C 26*		570750	
U 32		570785	
ASSOTHERM IPR-RAA Copper	M 15		570110
	M 18		570120
	M 22		570130
	M 28		570140
	M 35		570150
	M 42 (PZ-4G)		570160
	M 54 (PZ-4G)		570170
	M 42 (PR-3S)	Z2	572706
	M 54 (PR-3S)	Z2	572708
	M 76,1 XL (PR-3S)	Z6 XL ³⁾ / Z7 XL 45 kN ⁴⁾	579101
	M 88,9 G XL (PR-3S)	Z6 XL ³⁾ / Z7 XL 45 kN ⁴⁾	579110
	M 108,0 G XL (PR-3S)	Z6 XL ³⁾ / Z7 XL 45 kN ⁴⁾	579111
	M 15 S (PR-2B)	Z8	574738
	M 18 S (PR-2B)	Z8	574740
	M 22 S (PR-2B)	Z8	574742
	M 28 S (PR-2B)	Z8	574744
	M 35 S (PR-2B)	Z8	574746
ASSOTHERM IPR-RAA Copper Gas	M 15		570110
	M 18		570120
	M 22		570130
	M 28		570140
	M 35		570150
	M 15 S (PR-2B)	Z8	574738
	M 18 S (PR-2B)	Z8	574740
	M 22 S (PR-2B)	Z8	574742
	M 28 S (PR-2B)	Z8	574744
	M 35 S (PR-2B)	Z8	574746

System	Pressing tongs / pressing rings	Driven by adapter tongs	Art.-No.
ASTM F 1807 (Fittings with Copper Crimp Ring for PEX tubing)	US 3/8"		571450
	US 1/2"		571455
	US 3/4"		571460
	US 1"		571465
	US 1 1/4"		571470
	US 1 1/2"		571475
	US 2"		571477
ATUSA ITALIA SYCPRESS CARBON STEEL PRESS FITTINGS	M 15		570110
	M 18		570120
	M 22		570130
	M 28		570140
	M 35		570150
	M 42 (PR-3S)	Z2	572706
	M 54 (PR-3S)	Z2	572708
	M 76,1 XL (PR-3S)	Z6 XL ³⁾ / Z7 XL 45 kN ⁴⁾	579101
	M 88,9 G XL (PR-3S)	Z6 XL ³⁾ / Z7 XL 45 kN ⁴⁾	579110
	M 108,0 G XL (PR-3S)	Z6 XL ³⁾ / Z7 XL 45 kN ⁴⁾	579111
M 15 S (PR-2B)	Z8	574738	
M 18 S (PR-2B)	Z8	574740	
M 22 S (PR-2B)	Z8	574742	
M 28 S (PR-2B)	Z8	574744	
M 35 S (PR-2B)	Z8	574746	
ATUSA ITALIA SYCPRESS STAINLESS STEEL PRESS FITTINGS	M 15		570110
	M 18		570120
	M 22		570130
	M 28		570140
	M 35		570150
	M 42 (PR-3S)	Z2	572706
	M 54 (PR-3S)	Z2	572708
	M 76,1 XL (PR-3S)	Z6 XL ³⁾ / Z7 XL 45 kN ⁴⁾	579101
	M 88,9 G XL (PR-3S)	Z6 XL ³⁾ / Z7 XL 45 kN ⁴⁾	579110
	M 108,0 G XL (PR-3S)	Z6 XL ³⁾ / Z7 XL 45 kN ⁴⁾	579111
M 15 S (PR-2B)	Z8	574738	
M 18 S (PR-2B)	Z8	574740	
M 22 S (PR-2B)	Z8	574742	
M 28 S (PR-2B)	Z8	574744	
M 35 S (PR-2B)	Z8	574746	
AUSTEC PEX-B, PEX-AL-PEX (AUS)	TH 16*		570460
	TH 20*		570470
	TH 25*		570495
	TH 32		570480
	U 16*		570765
	U 20*		570775
	U 25*		570780
U 32		570785	
AUSTEC PEX-AL-PEX GAS (AUS)	TH 16*		570460
	TH 20*		570470
	TH 25*		570495
	TH 32		570480
	U 16*		570765
	U 20*		570775
	U 25*		570780
AYOR FIXOCONNECT Press	H 12*		570300
	H 16*		570320
	H 20*		570350
	H 25*		570360
	RFz 12*		571320
	RFz 16*		571325
	RFz 20*		571330
	RFz 25		571335
	U 16*		570765
	U 20*		570775
U 25*		570780	
AYOR FIXOMULTIX	H 16*		570320
	H 20*		570350
	H 26*		570370
	H 32		570380
	TH 16*		570460
	TH 20*		570470
	TH 26*		570475
	TH 32		570480
	TH 16 S (PR-2B)	Z8	574782
	TH 20 S (PR-2B)	Z8	574788
TH 26 S (PR-2B)	Z8	574794	
TH 32 S (PR-2B)	Z8	574798	
U 16*		570765	
U 20*		570775	
U 32		570785	
U 40		570790	
U 50		570795	
U 63 (PR-3B)	Z4	572837	
U 63 (PZ-S)		572365	
U 75 (PR-3B)	Z4	572828	
AYOR SOMATHERM FOR YOU -1	H 16*		570320
	H 20*		570350
	H 26*		570370
	TH 16*		570460
	TH 20*		570470
	TH 26*		570475
	TH 16 S (PR-2B)	Z8	574782
	TH 20 S (PR-2B)	Z8	574788
TH 26 S (PR-2B)	Z8	574794	
U 16*		570765	
U 20*		570775	

REMS pressing tongs

REMS pressing rings

Accessories for REMS radial presses (except for REMS Mini-Press) and suitable radial presses of other makes

System	Pressing tongs/ pressing rings	Driven by adapter tongs	Art.-No.
AYOR	H 12*		570300
SOMATHERM	H 16*		570320
FOR YOU - 2	H 20*		570350
	H 25*		570360
	RFz 12*		571320
	RFz 16*		571325
	RFz 20*		571330
	RFz 25		571335
	U 16*		570765
	U 20*		570775
	U 25*		570780
B			
Bampi BALPEX serie LP	TH 16*		570460
	TH 18*		570465
	TH 20*		570470
	TH 26*		570475
	TH 32		570480
	TH 40		570485
	TH 50 (PZ-S)		572400
	TH 63 (PZ-S)		572405
	TH 16 S (PR-2B)	Z8	574782
	TH 20 S (PR-2B)	Z8	574788
	TH 26 S (PR-2B)	Z8	574794
	TH 32 S (PR-2B)	Z8	574798
	U 16*		570765
	U 18*		570770
	U 20*		570775
	C 26*		570750
	U 32		570785
	U 40		570790
	U 50		570795
	U 63 (PR-3B)	Z4	572837
	U 63 (PZ-S)		572365
Bampi BALPEX serie MP	TH 16*		570460
	TH 18*		570465
	TH 20*		570470
	TH 26*		570475
	TH 32		570480
	TH 40		570485
	TH 50 (PZ-S)		572400
	TH 63 (PZ-S)		572405
	TH 16 S (PR-2B)	Z8	574782
	TH 20 S (PR-2B)	Z8	574788
	TH 26 S (PR-2B)	Z8	574794
	TH 32 S (PR-2B)	Z8	574798
Bampi BALPEX Gas	TH 16*		570460
	TH 20*		570470
	TH 26*		570475
	TH 16 S (PR-2B)	Z8	574782
	TH 20 S (PR-2B)	Z8	574788
	TH 32 S (PR-2B)	Z8	574798
BARBI EASYPRESS (Industrial Blansol)	H 12*		570300
	H 16*		570320
	H 20*		570350
	H 25*		570360
	H 32		570380
	RFz 12*		571320
	RFz 16*		571325
	RFz 20*		571330
	RFz 25		571335
	RFz 32		571340
	U 16*		570765
	U 20*		570775
	U 25*		570780
	U 32		570785

System	Pressing tongs/ pressing rings	Driven by adapter tongs	Art.-No.	
BARBI MULTIPEX (Industrial Blansol)	H 14*		570310	
	H 16*		570320	
	H 18*		570340	
	H 20*		570350	
	H 25*		570360	
	H 26*		570370	
	H 32		570380	
	RFz 16*		571325	
	RFz 18*		571327	
	RFz 20*		571330	
	RFz 25		571335	
	RFz 32		571340	
	TH 16*		570460	
	TH 20*		570470	
	TH 26*		570475	
	TH 32		570480	
	TH 16 S (PR-2B)	Z8	574782	
	TH 20 S (PR-2B)	Z8	574788	
	TH 26 S (PR-2B)	Z8	574794	
	TH 32 S (PR-2B)	Z8	574798	
	U 16*		570765	
	U 18*		570770	
	U 20*		570775	
U 25*		570780		
U 32		570785		
U 40		570790		
U 50		570795		
U 63 (PR-3B)	Z4	572837		
U 63 (PZ-S)		572365		
BEGETUBE/ IVAR	B 14*		570845	
	B 16*		570850	
	B 18*		570855	
	B 20*		570860	
	B 26		570870	
	B 32		570880	
	Fz 40		570742	
	Fz 50		570747	
	F 63 (PZ-S)		572385	
	Fz 75 (PR-3B)	Z4	572830	
	Béné inox Série 41	M 15		570110
		M 18		570120
		M 22		570130
M 28			570140	
M 35			570150	
M 42 (PR-3S)		Z2	572706	
M 54 (PR-3S)		Z2	572708	
M 76.1 XL (PR-3S)		Z6 XL ³⁾ / Z7 XL 45 kN ⁴⁾	579101	
M 88.9 G XL (PR-3S)		Z6 XL ³⁾ / Z7 XL 45 kN ⁴⁾	579110	
M 108.0 G XL (PR-3S)		Z6 XL ³⁾ / Z7 XL 45 kN ⁴⁾	579111	
M 15 S (PR-2B)		Z8	574738	
M 18 S (PR-2B)		Z8	574740	
M 22 S (PR-2B)		Z8	574742	
M 28 S (PR-2B)		Z8	574744	
M 35 S (PR-2B)	Z8	574746		
Brass Form Master Press	H 16*		570320	
	H 18*		570340	
	H 20*		570350	
	TH 16*		570460	
	TH 18*		570465	
	TH 20*		570470	
	TH 16 S (PR-2B)	Z8	574782	
	TH 20 S (PR-2B)	Z8	574788	
	U 16*		570765	
	U 18*		570770	
U 20*		570775		
Brass & Fittings PRESSMAN MultiPress	RFz 16*		571325	
	RFz 18*		571327	
	ACz 20*		572646	
Brass & Fittings PRESSMAN RetiPress	RFz 25		571335	
	RFz 32		571340	
	RFz 16*		571325	
RFz 18*		571327		
ACz 20*		572646		
RFz 25		571335		
RFz 32		571340		

Pressfitting systems for gas installations must only be pressed with pressing tongs/pressing rings which are highlighted in yellow.

Observe the national regulations. Read and observe the instructions for use and the installation instructions of the system provider/manufacturer.

* These pressing tongs also fit the manual radial press REMS Eco-Press. Observe the national regulations.

- 1) Only pressing tongs from designation "108" (1st quarter of 2008), "208" (2nd quarter of 2008) etc. can be used. The designation is stamped on every pressing jaw.
- 2) For this pressfitting system producing a pressing joint with manual radial presses is not permitted.
- 3) Driven by REMS Power-Press XL ACC.
- 4) Driven by REMS Akku-Press XL 45 kN 22 V ACC.
- 5) For taking suitable pressing inserts.
- 6) Press fittings made of red bronze (Sanpress XL) must be pressed with pressing rings with press contour VR, copper fittings (Profipress XL, Profipress G XL), carbon steel (Prestabo XL) and stainless steel fittings (Sanpress Inox XL, Sanpress Inox G XL) with pressing rings with press contour VF.
- 7) Use pressing rings labelled "M 88.9 G" or "M 108 G" on the three pressing segments for gas installations.
- 8) For making press joints for operating pressure \leq PN 10.
- 9) For pipes of the EN technical standard. Observe the instructions for use of the system provider/manufacturer.
- 10) For pipes of the ASTM technical standard. Observe the instructions for use of the system provider/manufacturer.

The suitability of REMS pressing tools for pressfitting systems: Date 12.10.2022. For the updated situation regarding suitability status check our website: www.rems.de > Downloads > Product catalogues, brochures > REMS Catalogue.

See page 236 for adapter tongs. Pressing tongs/pressing rings for additional pressfitting systems on request.

REMS pressing tongs REMS pressing rings

Accessories for REMS radial presses (except for REMS Mini-Press)
and suitable radial presses of other makes

System	Pressing tongs / pressing rings	Driven by adapter tongs	Art.-No.	
BRASSTECH MULTItermoSAN Brasspress	B 16*		570850	
	B 20*		570860	
	B 26		570870	
	B 32		570880	
	F 16*		570717	
	F 20*		570727	
	F 26*		570730	
	F 16 S (PR-2B)	Z8	574728	
	F 20 S (PR-2B)	Z8	574730	
	F 26 S (PR-2B)	Z8	574732	
	H 16*		570320	
	H 18*		570340	
	H 20*		570350	
	H 26*		570370	
	TH 16*		570460	
	TH 18*		570465	
	TH 20*		570470	
	TH 26*		570475	
	TH 32		570480	
	TH 40		570485	
	TH 50 (PZ-S)		572400	
	TH 63 (PZ-S)		572405	
	TH 16 S (PR-2B)	Z8	574782	
	TH 20 S (PR-2B)	Z8	574788	
	TH 26 S (PR-2B)	Z8	574794	
	TH 32 S (PR-2B)	Z8	574798	
	U 16*		570765	
	U 18*		570770	
	U 20*		570775	
	C 26*		570750	
	U 32		570785	
	C			
	Cello Products >B< Press	VUS ½" (OD 15,9 mm)		571770
VUS ¾" (OD 22,2 mm)			571775	
VUS 1" (OD 28,6 mm)			571780	
VUS 1¼" (OD 34,9 mm)			571785	
VUS 1½" (OD 41,3 mm)			571790	
VUS 2" (OD 54,0 mm)			571795	
CGR DYNAFLU multicouche		H 16*		570320
	H 20*		570350	
	H 26*		570370	
	H 32		570380	
	TH 16*		570460	
	TH 20*		570470	
	TH 26*		570475	
	TH 32		570480	
	TH 40		570485	
	TH 50 (PZ-S)		572400	
	TH 63 (PZ-S)		572405	
	TH 16 S (PR-2B)	Z8	574782	
	TH 20 S (PR-2B)	Z8	574788	
	TH 26 S (PR-2B)	Z8	574794	
	TH 32 S (PR-2B)	Z8	574798	
	U 16*		570765	
	U 20*		570775	
U 32		570785		
U 40		570790		
U 50		570795		
U 63 (PR-3B)	Z4	572837		
U 63 (PZ-S)		572365		
CGR DYNAFLU PER	H 12*		570300	
	H 16*		570320	
	H 20*		570350	
	H 25*		570360	
	Rfz 12*		571320	
	Rfz 16*		571325	
	Rfz 20*		571330	
	Rfz 25		571335	
CHIALI CHIALIPEX	TH 16*		570460	
	TH 20*		570470	
	TH 26*		570475	
	TH 32		570480	
	TH 40		570485	
	TH 50 (PZ-S)		572400	
	TH 63 (PZ-S)		572405	
Climatek Clima Therm	TH 14*		570455	
	TH 16*		570460	
	TH 18*		570465	
	TH 20*		570470	
	TH 26*		570475	
	TH 32		570480	
	H 40 A (PZ-4G)		570695	
Climatrix Climatrix Rhinopex	H 16*		570320	
	H 20*		570350	
	U 16*		570765	
	U 20*		570775	
	C 26*		570750	
	TH 14*		570455	
	TH 16*		570460	
	TH 18*		570465	
	TH 20*		570470	
	TH 26*		570475	
	TH 32		570480	
	TH 16 S (PR-2B)	Z8	574782	
	TH 20 S (PR-2B)	Z8	574788	
	TH 26 S (PR-2B)	Z8	574794	
	TH 32 S (PR-2B)	Z8	574798	
	Climatrix Variotherm System TH	TH 11,6*		570482
TH 16*			570460	
TH 16 S (PR-2B)		Z8	574782	
ClouSet	TH 16*		570460	
	TH 18*		570465	
	TH 20*		570470	
	TH 16 S (PR-2B)	Z8	574782	
	TH 20 S (PR-2B)	Z8	574788	
Comap PEX Press	Rfz 12*		571320	
	Rfz 16*		571325	
	Rfz 20*		571330	
	Rfz 25		571335	

System	Pressing tongs / pressing rings	Driven by adapter tongs	Art.-No.
Comap Multiskin	TH 14*		570455
	TH 16*		570460
	TH 18*		570465
	TH 20*		570470
	TH 26*		570475
	TH 32		570480
	THL 32		570487
	TH 40		570485
	TH 50 (PZ-S)		572400
	TH 63 (PZ-S)		572405
	THz 75 (PR-3B)	Z4	572829
	TH 16 S (PR-2B)	Z8	574782
	TH 20 S (PR-2B)	Z8	574788
	TH 26 S (PR-2B)	Z8	574794
	TH 32 S (PR-2B)	Z8	574798
	U 14*		570760
	U 16*		570765
	U 18*		570770
	U 20*		570775
	U 32		570785
	U 40		570790
	U 50		570795
	U 63 (PR-3B)	Z4	572837
	U 63 (PZ-S)		572365
	U 75 (PR-3B)	Z4	572828
	H 14*		570310
	H 16*		570320
	H 18*		570340
	H 20*		570350
	H 26*		570370
	H 32		570380
	H 40 (PZ-4G)		570390
	Comap Multiskin Gas	TH 16*	
TH 20*			570470
TH 26*			570475
TH 32			570480
THL 32			570487
TH 16 S (PR-2B)		Z8	574782
TH 20 S (PR-2B)		Z8	574788
TH 26 S (PR-2B)		Z8	574794
TH 32 S (PR-2B)		Z8	574798
U 16*			570765
U 20*			570775
U 32			570785
H 16*			570320
H 20*		570350	
H 26*		570370	
H 32		570380	
COMISA Press System	TH 14*		570455
	TH 16*		570460
	TH 18*		570465
	TH 20*		570470
	TH 25*		570495
	TH 26*		570475
	TH 32		570480
	TH 40		570485
	TH 50 (PZ-S)		572400
	TH 63 (PZ-S)		572405
	TH 16 S (PR-2B)	Z8	574782
	TH 20 S (PR-2B)	Z8	574788
	TH 26 S (PR-2B)	Z8	574794
	TH 32 S (PR-2B)	Z8	574798
	H 14*		570310
	H 16*		570320
	H 18*		570340
H 20*		570350	
H 26*		570370	
H 32		570380	
H 14*		570845	
B 16*		570850	
B 18*		570855	
B 20*		570860	
B 26		570870	
B 32		570880	
COMISA Press System Gas	TH 16*		570460
	TH 20*		570470
	TH 26*		570475
	TH 32		570480
	TH 16 S (PR-2B)	Z8	574782
	TH 20 S (PR-2B)	Z8	574788
	TH 26 S (PR-2B)	Z8	574794
TH 32 S (PR-2B)	Z8	574798	
CONEL CONNECT MULTI	F 16*		570717
	F 20*		570727
	F 26*		570730
	F 32		570735
	F 16 S (PR-2B)	Z8	574728
	F 20 S (PR-2B)	Z8	574730
	F 26 S (PR-2B)	Z8	574732
	F 32 S (PR-2B)	Z8	574734
	H 16*		570320
	H 20*		570350
	H 26*		570370
H 32		570380	
TH 16*		570460	
TH 20*		570470	
TH 26*		570475	
TH 32		570480	
TH 16 S (PR-2B)	Z8	574782	
TH 20 S (PR-2B)	Z8	574788	
TH 26 S (PR-2B)	Z8	574794	
TH 32 S (PR-2B)	Z8	574798	
U 16*		570765	
U 20*		570775	
U 25*		570780	
U 32		570785	
VP 16*		570910	
VP 20*		570915	
VP 32		570925	
(DN 26)			

REMS pressing tongs REMS pressing rings

Accessories for REMS radial presses (except for REMS Mini-Press) and suitable radial presses of other makes

System	Pressing tongs / pressing rings	Driven by adapter tongs	Art.-No.	
CONEL CONNECT MV2	F 16*		570717	
	F 20*		570727	
	F 26*		570730	
	F 32		570735	
	F 16 S (PR-2B)	Z8	574728	
	F 20 S (PR-2B)	Z8	574730	
	F 26 S (PR-2B)	Z8	574732	
	F 32 S (PR-2B)	Z8	574734	
	TH 16*		570460	
	TH 20*		570470	
	TH 26*		570475	
	TH 32		570480	
	TH 16 S (PR-2B)	Z8	574782	
	TH 20 S (PR-2B)	Z8	574788	
	TH 26 S (PR-2B)	Z8	574794	
	TH 32 S (PR-2B)	Z8	574798	
	Conex Bänninger >B<- Flex	F 16*		570717
F 18*			570720	
F 20*			570727	
F 32			570735	
F 14 S (PR-2B)		Z8	574728	
F 20 S (PR-2B)		Z8	574730	
F 32 S (PR-2B)		Z8	574734	
H 16*			570320	
H 18*			570340	
H 20*			570350	
H 25*			570360	
H 32			570380	
RFz 16*			571325	
RFz 18*			571327	
RFz 20*			571330	
RFz 25			571335	
RFz 32			571340	
TH 16*			570460	
TH 18*			570465	
TH 20*			570470	
TH 25*			570495	
TH 32			570480	
U 16*			570765	
U 18*		570770		
U 20*		570775		
U 25*		570780		
U 32		570785		
Conex Bänninger >B<- MaxiPro	BMP ¼"		571700	
	BMP ⅜"		571702	
	BMP ½"		571704	
	BMP ⅝"		571706	
	BMP ¾"		571708	
	BMP 7/8"		571710	
	BMP 1"		571712	
	BMP 1 1/8"		571714	
Conex Bänninger >B<- Press	V 12		570107	
	V 14		570112	
	V 15		570115	
	V 16		570117	
	V 18		570125	
	V 22		570135	
	V 28		570145	
	V 35		570155	
	V 42		570165	
	V 54		570175	
	V 12 S (PR-2B)	Z8	574748	
	V 14 S (PR-2B)	Z8	574800	
	V 15 S (PR-2B)	Z8	574752	
	V 16 S (PR-2B)	Z8	574802	
	V 18 S (PR-2B)	Z8	574756	
	V 22 S (PR-2B)	Z8	574758	
	V 28 S (PR-2B)	Z8	574760	
	V 35 S (PR-2B)	Z8	574762	
	Conex Bänninger >B<- Press Carbon	V 15		570115
		V 18		570125
V 22			570135	
V 28			570145	
V 35			570155	
V 42			570165	
V 54			570175	
V 15 S (PR-2B)		Z8	574752	
V 18 S (PR-2B)		Z8	574756	
V 22 S (PR-2B)		Z8	574758	
V 28 S (PR-2B)		Z8	574760	
V 35 S (PR-2B)		Z8	574762	

System	Pressing tongs / pressing rings	Driven by adapter tongs	Art.-No.
Conex Bänninger >B<- Press Gas	V 12		570107
	V 14		570112
	V 15		570115
	V 16		570117
	V 18		570125
	V 22		570135
	V 28		570145
	V 35		570155
	V 42		570165
	V 54		570175
	V 12 S (PR-2B)	Z8	574748
	V 14 S (PR-2B)	Z8	574800
	V 15 S (PR-2B)	Z8	574752
	V 16 S (PR-2B)	Z8	574802
	V 18 S (PR-2B)	Z8	574756
Conex Bänninger >B<- Press Inox	V 15		570115
	V 18		570125
	V 22		570135
	V 28		570145
	V 35		570155
	V 42		570165
	V 54		570175
	V 15 S (PR-2B)	Z8	574752
	V 18 S (PR-2B)	Z8	574756
	V 22 S (PR-2B)	Z8	574758
Conex Bänninger >B<- Press Solar	V 12		570107
	V 14		570112
	V 15		570115
	V 16		570117
	V 18		570125
	V 22		570135
	V 28		570145
	V 35		570155
	V 42		570165
	V 54		570175
Conex Bänninger >B<- Press XL	XP 64,0 XL (PR-3S)	Z6 XL ³⁾ / Z7 XL 45 kN ⁴⁾	579100
	XP 66,7 XL (PR-3S)	Z6 XL ³⁾ / Z7 XL 45 kN ⁴⁾	579108
	M 76,1 XL (PR-3S)	Z6 XL ³⁾ / Z7 XL 45 kN ⁴⁾	579101
Conex Bänninger >B<- Press XL copper	VFz 64,0 (PR-3B)	Z5	572815
	VFz 76,1 (PR-3B) ⁴⁾	Z5	572816
	VFz 88,9 (PR-3B) ⁴⁾	Z5	572817
Conex Bänninger >B<- Press XL stainless	XP 64,0 XL (PR-3S)	Z6 XL ³⁾ / Z7 XL 45 kN ⁴⁾	579100
	XP 66,7 XL (PR-3S)	Z6 XL ³⁾ / Z7 XL 45 kN ⁴⁾	579108
	M 76,1 XL (PR-3S)	Z6 XL ³⁾ / Z7 XL 45 kN ⁴⁾	579101
Conex Bänninger >B<- Press XL red brass	XP 64,0 XL (PR-3S)	Z6 XL ³⁾ / Z7 XL 45 kN ⁴⁾	579100
	XP 66,7 XL (PR-3S)	Z6 XL ³⁾ / Z7 XL 45 kN ⁴⁾	579108
	M 76,1 XL (PR-3S)	Z6 XL ³⁾ / Z7 XL 45 kN ⁴⁾	579101
D			
Debrunner Acifer d-a Presssystem C-Stahl	M 12		570100
	M 15		570110
	M 18		570120
	M 22		570130
	M 28		570140
	M 35		570150
	M 42 (PR-3S)	Z2	572706
	M 54 (PR-3S)	Z2	572708
	M 76,1 XL (PR-3S)	Z6 XL ³⁾ / Z7 XL 45 kN ⁴⁾	579101
	M 88,9 G XL (PR-3S)	Z6 XL ³⁾ / Z7 XL 45 kN ⁴⁾	579110
	M 108,0 G XL (PR-3S)	Z6 XL ³⁾ / Z7 XL 45 kN ⁴⁾	579111
	M 12 S (PR-2B)	Z8	574736
	M 15 S (PR-2B)	Z8	574738
M 18 S (PR-2B)	Z8	574740	
M 22 S (PR-2B)	Z8	574742	
M 28 S (PR-2B)	Z8	574744	
M 35 S (PR-2B)	Z8	574746	

Pressfitting systems for gas installations must only be pressed with pressing tongs/pressing rings which are highlighted in yellow.

Observe the national regulations. Read and observe the instructions for use and the installation instructions of the system provider/manufacturer.

* These pressing tongs also fit the manual radial press REMS Eco-Press. Observe the national regulations.

¹⁾ Only pressing tongs from designation "108" (1st quarter of 2008), "208" (2nd quarter of 2008) etc. can be used. The designation is stamped on every pressing jaw.

²⁾ For this pressfitting system producing a pressing joint with manual radial presses is not permitted.

³⁾ Driven by REMS Power-Press XL ACC.

⁴⁾ Driven by REMS Akku-Press XL 45 kN 22 V ACC.

⁵⁾ For taking suitable pressing inserts.

⁶⁾ Press fittings made of red bronze (Sanpress XL) must be pressed with pressing rings with press contour VR, copper fittings (Profipress XL, Profipress G XL), carbon steel (Prestabo XL) and stainless steel fittings (Sanpress Inox XL, Sanpress Inox G XL) with pressing rings with press contour VF.

⁷⁾ Use pressing rings labelled "M 88.9 G" or "M 108 G" on the three pressing segments for gas installations.

⁸⁾ For making press joints for operating pressure ≤ PN 10.

⁹⁾ For pipes of the EN technical standard. Observe the instructions for use of the system provider/manufacturer.

¹⁰⁾ For pipes of the ASTM technical standard. Observe the instructions for use of the system provider/manufacturer.

The suitability of REMS pressing tools for pressfitting systems: Date 12.10.2022. For the updated situation regarding suitability status check our website:

www.rems.de > Downloads > Product catalogues, brochures > REMS Catalogue.

See page 236 for adapter tongs. Pressing tongs/pressing rings for additional pressfitting systems on request.

REMS pressing tongs

REMS pressing rings

Accessories for REMS radial presses (except for REMS Mini-Press) and suitable radial presses of other makes

System	Pressing tongs / pressing rings	Driven by adapter tongs	Art.-No.
DIWAsystems	TH 14*		570455
	TH 16*		570460
	TH 20*		570470
	TH 26*		570475
	TH 32		570480
	TH 40		570485
	TH 50 (PZ-S)		572400
	TH 63 (PZ-S)		572405
DUOPIPE Systems	U 16*		570765
	U 18*		570770
	U 20*		570775
	U 25*		570780
	U 32		570785
DW Verbundrohr multitubo systems	U 16*		570765
	U 18*		570770
	U 20*		570775
	U 25*		570780
	U 32		570785
	U 40		570790
	U 50		570795
	U 63 (PR-3B)	Z4	572837
	U 63 (PZ-S)		572365
U 75 (PR-3B)	Z4	572828	

E

EBRILLE Isomonflex	U 16*		570765
	U 20*		570775
	U 25*		570780
	H 26*		570370
	TH 26*		570475
	TH 26 S (PR-2B)	Z8	574794
	U 32		570785
EBRILLE Monflex	U 16*		570765
	U 20*		570775
	U 25*		570780
	H 26*		570370
	TH 26*		570475
	TH 26 S (PR-2B)	Z8	574794
	U 32		570785
EFFEBI EFFEBI-PRESS Aisi316 System M Profile ¹⁾	M 15		570110
	M 18		570120
	M 22		570130
	M 28		570140
	M 35		570150
	M 42 (PR-3S)	Z2	572706
	M 54 (PR-3S)	Z2	572708
	M 76,1 XL (PR-3S)	Z6 XL ³⁾ / Z7 XL 45 kN ⁴⁾	579101
	M 88,9 G XL (PR-3S)	Z6 XL ³⁾ / Z7 XL 45 kN ⁴⁾	579110
	M 108,0 G XL (PR-3S) ⁵⁾	Z6 XL ³⁾ / Z7 XL 45 kN ⁴⁾	579111
	M 15 S (PR-2B)	Z8	574738
	M 18 S (PR-2B)	Z8	574740
	M 22 S (PR-2B)	Z8	574742
	M 28 S (PR-2B)	Z8	574744
	M 35 S (PR-2B)	Z8	574746
EFFEBI EFFEBI-PRESS Aisi316 System V Profile ¹⁾	V 12		570107
	V 15		570115
	V 18		570125
	V 22		570135
	V 28		570145
	V 35		570155
	V 42		570165
	V 42 (PR-2B)	Z2	572850
	V 54		570175
	V 54 (PR-2B)	Z2	572851
	V 12 S (PR-2B)	Z8	574748
	V 15 S (PR-2B)	Z8	574752
	V 18 S (PR-2B)	Z8	574756
	V 22 S (PR-2B)	Z8	574758
	V 28 S (PR-2B)	Z8	574760
V 35 S (PR-2B)	Z8	574762	
EFFEBI EFFEBI-PRESS Carbon-S System M Profile ¹⁾	M 12		570100
	M 15		570110
	M 18		570120
	M 22		570130
	M 28		570140
	M 35		570150
	M 42 (PR-3S)	Z2	572706
	M 54 (PR-3S)	Z2	572708
	M 76,1 XL (PR-3S)	Z6 XL ³⁾ / Z7 XL 45 kN ⁴⁾	579101
	M 88,9 G XL (PR-3S)	Z6 XL ³⁾ / Z7 XL 45 kN ⁴⁾	579110
	M 108,0 G XL (PR-3S)	Z6 XL ³⁾ / Z7 XL 45 kN ⁴⁾	579111
	M 12 S (PR-2B)	Z8	574738
	M 15 S (PR-2B)	Z8	574738
	M 18 S (PR-2B)	Z8	574740
	M 22 S (PR-2B)	Z8	574742
M 28 S (PR-2B)	Z8	574744	
M 35 S (PR-2B)	Z8	574746	
EFFEBI EFFEBI-PRESS Carbon-S System V Profile ¹⁾	V 12		570107
	V 15		570115
	V 18		570125
	V 22		570135
	V 28		570145
	V 35		570155
	V 42		570165
	V 42 (PR-2B)	Z2	572850
	V 54		570175
	V 54 (PR-2B)	Z2	572851
	V 12 S (PR-2B)	Z8	574748
	V 15 S (PR-2B)	Z8	574752
	V 18 S (PR-2B)	Z8	574756
	V 22 S (PR-2B)	Z8	574758
	V 28 S (PR-2B)	Z8	574760
V 35 S (PR-2B)	Z8	574762	

System	Pressing tongs / pressing rings	Driven by adapter tongs	Art.-No.	
EFFEBI EFFEBI-PRESS UNICO	V 12		570107	
	V 15		570115	
	V 18		570125	
	V 22		570135	
	V 28		570145	
	V 35		570155	
	V 42		570165	
	V 42 (PR-2B)	Z2	572850	
	V 54		570175	
	V 54 (PR-2B)	Z2	572851	
	V 12 S (PR-2B)	Z8	574748	
	V 15 S (PR-2B)	Z8	574752	
	V 18 S (PR-2B)	Z8	574756	
	V 22 S (PR-2B)	Z8	574758	
	V 28 S (PR-2B)	Z8	574760	
V 35 S (PR-2B)	Z8	574762		
EFFEBI EFFEBI-PRESS UNICO (GAS)	V 12		570107	
	V 15		570115	
	V 18		570125	
	V 22		570135	
	V 28		570145	
	V 35		570155	
	V 42		570165	
	V 42 (PR-2B)	Z2	572850	
	V 54		570175	
	V 54 (PR-2B)	Z2	572851	
	V 12 S (PR-2B)	Z8	574748	
	V 15 S (PR-2B)	Z8	574752	
	V 18 S (PR-2B)	Z8	574756	
	V 22 S (PR-2B)	Z8	574758	
	V 28 S (PR-2B)	Z8	574760	
V 35 S (PR-2B)	Z8	574762		
EFFEBI PRESSTIGE	M 15		570110	
	M 18		570120	
	M 22		570130	
	M 28		570140	
	M 35		570150	
	M 15 S (PR-2B)	Z8	574738	
	M 18 S (PR-2B)	Z8	574740	
	M 22 S (PR-2B)	Z8	574742	
	M 28 S (PR-2B)	Z8	574744	
	M 35 S (PR-2B)	Z8	574746	
	V 15		570115	
	V 18		570125	
	V 22		570135	
	V 28		570145	
	V 35		570155	
V 42		570165		
V 42 (PR-2B)	Z2	572850		
V 54		570175		
V 54 (PR-2B)	Z2	572851		
V 15 S (PR-2B)	Z8	574752		
V 18 S (PR-2B)	Z8	574756		
V 22 S (PR-2B)	Z8	574758		
V 28 S (PR-2B)	Z8	574760		
V 35 S (PR-2B)	Z8	574762		
EFFEBI PRESSTIGE 4E05	M 15		570110	
	M 18		570120	
	M 22		570130	
	M 28		570140	
	M 35		570150	
	M 42 (PR-3S)	Z2	572706	
	M 54 (PR-3S)	Z2	572708	
	M 15 S (PR-2B)	Z8	574738	
	M 18 S (PR-2B)	Z8	574740	
	M 22 S (PR-2B)	Z8	574742	
	M 28 S (PR-2B)	Z8	574744	
	M 35 S (PR-2B)	Z8	574746	
	EFFEBI PRESSTIGE-GAS ⁹⁾	M 15		570110
		M 18		570120
		M 22		570130
M 28			570140	
M 35			570150	
M 15 S (PR-2B)		Z8	574738	
M 18 S (PR-2B)		Z8	574740	
M 22 S (PR-2B)		Z8	574742	
M 28 S (PR-2B)		Z8	574744	
M 35 S (PR-2B)		Z8	574746	
V 15			570115	
V 18			570125	
V 22			570135	
V 28			570145	
V 35			570155	
V 42		570165		
V 42 (PR-2B)	Z2	572850		
V 54		570175		
V 54 (PR-2B)	Z2	572851		
V 15 S (PR-2B)	Z8	574752		
V 18 S (PR-2B)	Z8	574756		
V 22 S (PR-2B)	Z8	574758		
V 28 S (PR-2B)	Z8	574760		
V 35 S (PR-2B)	Z8	574762		
EFFEBI TOF-GAS MULTIPINZA	TH 16*		570460	
	TH 20*		570470	
	TH 26*		570475	
	TH 32		570480	
	TH 16 S (PR-2B)	Z8	574782	
	TH 20 S (PR-2B)	Z8	574788	
	TH 26 S (PR-2B)	Z8	574794	
	TH 32 S (PR-2B)	Z8	574798	
	H 16*		570320	
	H 20*		570350	
	H 26*		570370	
	H 32		570380	
	H 40 (PZ-4G)		570390	
	U 16*		570765	
	U 20*		570775	
U 32		570785		

REMS pressing tongs

REMS pressing rings

Accessories for REMS radial presses (except for REMS Mini-Press) and suitable radial presses of other makes

System	Pressing tongs / pressing rings	Driven by adapter tongs	Art.-No.
EFFEBI	TH 16*		570460
	TOF		570465
	MULTIPINZA		570470
	TH 20*		570475
MULTIPINZA	TH 26*		570480
	TH 32		570485
	TH 40		572400
	TH 50 (PZ-S)		572405
	TH 63 (PZ-S)		574782
	TH 16 S (PR-2B)	Z8	574788
	TH 20 S (PR-2B)	Z8	574794
	TH 26 S (PR-2B)	Z8	574798
	TH 32 S (PR-2B)	Z8	570717
	F 16*		570720
	F 18*		570727
	F 20*		570730
	F 26*		570735
	F 32		570742
	Fz 40		570747
	Fz 50		572385
	F 63 (PZ-S)		574728
	F 16 S (PR-2B)	Z8	574730
	F 20 S (PR-2B)	Z8	574732
	F 26 S (PR-2B)	Z8	574734
	F 32 S (PR-2B)	Z8	570320
	H 16*		570340
	H 18*		570350
	H 20*		570370
	H 26*		570380
	H 32		570390
	H 40 (PZ-4G)		570765
	U 16*		570770
	U 18*		570775
	U 20*		570780
	U 25*		570750
	C 26*		570785
U 32		570790	
U 40		570795	
U 50		572837	
U 63 (PR-3B)	Z4	572365	
U 63 (PZ-S)		570850	
B 16*		570855	
B 18*		570860	
B 20*		570870	
B 26		570880	
B 32		570765	
EFIELD MULTILAYER PRESS DINGAS	U 16*		570770
	U 18*		570775
	U 20*		570780
	U 25*		570785
	U 32		570765
EFIELD MULTILAYER PRESS WATER	U 16*		570770
	U 18*		570775
	U 20*		570780
	U 25*		570785
	U 32		571770
Elkhart APOLLOXPRESS Fittings Copper and Low-Lead Brass	VUS 1/2" (OD 15,9 mm)		571775
	VUS 3/4" (OD 22,2 mm)		571780
	VUS 1" (OD 28,6 mm)		571785
	VUS 1 1/4" (OD 34,9 mm)		571790
	VUS 1 1/2" (OD 41,3 mm)		571795
	VUS 2" (OD 54,0 mm)		572819
Elkhart APOLLOXPRESS LD-C Fittings Copper	VUSFz 2 1/2" (PR-3B) (OD 66,7 mm)	Z5	572820
	VUSFz 3" (PR-3B) (OD 79,4 mm)	Z5	572821
	VUSFz 4" (PR-3B) (OD 104,8 mm)	Z5	
ELYDAN izeo	RFz 16*		571325
	RFz 20*		571330
	RFz 25		571337
	RFz 32		571342
	U 16*		570765
	U 20*		570775
	U 25*		570780
	U 32		570785
	U 40		570790
	U 50		570795
	U 63 (PR-3B)	Z4	572837
	U 63 (PZ-S)		572365

System	Pressing tongs / pressing rings	Driven by adapter tongs	Art.-No.
EMMETI GERPEX-FIVPRESS	B 16*		570850
	B 20*		570860
	B 26		570870
	B 32		570880
	H 16*		570320
	H 20*		570350
	TH 16*		570460
	TH 20*		570470
	TH 26*		570475
	TH 32		570480
	TH 40		570485
	TH 50 (PZ-S)		572400
EMPUR	TH 63 (PZ-S)		572405
	U 16*		570765
	U 20*		570775
	TH 14*		570455
	TH 15*		570457
	TH 16*		570460
	TH 17*		570462
	TH 20*		570470
	TH 25*		570495
	TH 16 S (PR-2B)	Z8	574782
	TH 20 S (PR-2B)	Z8	574788
	Esta Rohr simplesta SH M	M 15	
M 18			570120
M 22			570130
M 28			570140
M 35			570150
M 42 (PZ-4G)			570160
M 42 (PR-3S)		Z2	572706
M 54 (PR-3S)		Z2	572708
M 76.1 XL (PR-3S)		Z6 XL ³⁾ / Z7 XL 45 kN ⁴⁾	579101
M 88.9 G XL (PR-3S)		Z6 XL ³⁾ / Z7 XL 45 kN ⁴⁾	579110
M 108.0 G XL (PR-3S) ⁸⁾		Z6 XL ³⁾ / Z7 XL 45 kN ⁴⁾	579111
M 15 S (PR-2B)		Z8	574738
Esta Rohr simplesta ST M	M 18 S (PR-2B)	Z8	574740
	M 22 S (PR-2B)	Z8	574742
	M 28 S (PR-2B)	Z8	574744
	M 35 S (PR-2B)	Z8	574746
	M 15		570110
	M 18		570120
	M 22		570130
	M 28		570140
	M 35		570150
	M 42 (PZ-4G)		570160
	M 54 (PR-3S)		570170
	M 42 (PR-3S)	Z2	572706
EUROTUBI EUROPA C-Steel Pressfitting System M-Profile ¹⁾	M 54 (PR-3S)	Z2	572708
	M 76.1 XL (PR-3S)	Z6 XL ³⁾ / Z7 XL 45 kN ⁴⁾	579101
	M 88.9 G XL (PR-3S)	Z6 XL ³⁾ / Z7 XL 45 kN ⁴⁾	579110
	M 108.0 G XL (PR-3S) ⁸⁾	Z6 XL ³⁾ / Z7 XL 45 kN ⁴⁾	579111
	M 15 S (PR-2B)	Z8	574738
	M 18 S (PR-2B)	Z8	574740
	M 22 S (PR-2B)	Z8	574742
	M 28 S (PR-2B)	Z8	574744
	M 35 S (PR-2B)	Z8	574746
	M 12		570100
	M 15		570110
	M 18		570120
M 22		570130	
M 28		570140	
M 35		570150	
M 42 (PR-3S)	Z2	572706	
M 54 (PR-3S)	Z2	572708	
M 76.1 XL (PR-3S)	Z6 XL ³⁾ / Z7 XL 45 kN ⁴⁾	579101	
M 88.9 G XL (PR-3S)	Z6 XL ³⁾ / Z7 XL 45 kN ⁴⁾	579110	
M 108.0 G XL (PR-3S)	Z6 XL ³⁾ / Z7 XL 45 kN ⁴⁾	579111	
M 12 S (PR-2B)	Z8	574736	
M 15 S (PR-2B)	Z8	574738	
M 18 S (PR-2B)	Z8	574740	
M 22 S (PR-2B)	Z8	574742	
M 28 S (PR-2B)	Z8	574744	
M 35 S (PR-2B)	Z8	574746	

Pressfitting systems for gas installations must only be pressed with pressing tongs/pressing rings which are highlighted in yellow.

Observe the national regulations. Read and observe the instructions for use and the installation instructions of the system provider/manufacturer.

* These pressing tongs also fit the manual radial press REMS Eco-Press. Observe the national regulations.

¹⁾ Only pressing tongs from designation "108" (1st quarter of 2008), "208" (2nd quarter of 2008) etc. can be used. The designation is stamped on every pressing jaw.

²⁾ For this pressfitting system producing a pressing joint with manual radial presses is not permitted.

³⁾ Driven by REMS Power-Press XL ACC.

⁴⁾ Driven by REMS Akku-Press XL 45 kN 22 V ACC.

⁵⁾ For taking suitable pressing inserts.

⁶⁾ Press fittings made of red bronze (Sanpress XL) must be pressed with pressing rings with press contour VR, copper fittings (Profipress XL, Profipress G XL), carbon steel (Prestabo XL) and stainless steel fittings (Sanpress Inox XL, Sanpress Inox G XL) with pressing rings with press contour VF.

⁷⁾ Use pressing rings labelled "M 88.9 G" or "M 108 G" on the three pressing segments for gas installations.

⁸⁾ For making press joints for operating pressure ≤ PN 10.

⁹⁾ For pipes of the EN technical standard. Observe the instructions for use of the system provider/manufacturer.

¹⁰⁾ For pipes of the ASTM technical standard. Observe the instructions for use of the system provider/manufacturer.

The suitability of REMS pressing tools for pressfitting systems: Date 12.10.2022. For the updated situation regarding suitability status check our website:

www.rems.de > Downloads > Product catalogues, brochures > REMS Catalogue.

See page 236 for adapter tongs. Pressing tongs/pressing rings for additional pressfitting systems on request.

REMS pressing tongs

REMS pressing rings

Accessories for REMS radial presses (except for REMS Mini-Press) and suitable radial presses of other makes

System	Pressing tongs / pressing rings	Driven by adapter tongs	Art.-No.
EUROTUBI EUROPA Inox Pressfitting System M-Profile ¹⁾	M 15		570110
	M 18		570120
	M 22		570130
	M 28		570140
	M 35		570150
	M 42 (PR-3S)	Z2	572706
	M 54 (PR-3S)	Z2	572708
	M 76,1 XL (PR-3S)	Z6 XL ³⁾ / Z7 XL 45 kN ⁴⁾	579101
	M 88,9 G XL (PR-3S)	Z6 XL ³⁾ / Z7 XL 45 kN ⁴⁾	579110
	M 108,0 G XL (PR-3S)	Z6 XL ³⁾ / Z7 XL 45 kN ⁴⁾	579111
	M 15 S (PR-2B)	Z8	574738
	M 18 S (PR-2B)	Z8	574740
	M 22 S (PR-2B)	Z8	574742
	M 28 S (PR-2B)	Z8	574744
M 35 S (PR-2B)	Z8	574746	
Evans Components	VAU 15 (½")		572687
	VAU 20 (¾")		572689
Presslok	VAU 25 (1")		572691
	ECI 1½"		571932
	ECI 2" (PZ-4G)		571934
	ECI 2½" XL (PR-3S)	Z6 XL ³⁾ / Z7 XL 45 kN ⁴⁾	579104
	ECI 3" XL (PR-3S)	Z6 XL ³⁾ / Z7 XL 45 kN ⁴⁾	579105
	ECI 4" XL (PR-3S)	Z6 XL ³⁾ / Z7 XL 45 kN ⁴⁾	579106

F

FAR Rubinetterie PRESSFAR	TH 14*		570455	
	TH 16*		570460	
	TH 17*		570462	
	TH 18*		570465	
	TH 20*		570470	
	TH 25*		570495	
	TH 26*		570475	
	TH 32		570480	
	TH 40		570485	
	TH 50 (PZ-S)		572400	
	TH 63 (PZ-S)		572405	
	TH 16 S (PR-2B)	Z8	574782	
	TH 20 S (PR-2B)	Z8	574788	
	TH 26 S (PR-2B)	Z8	574794	
	TH 32 S (PR-2B)	Z8	574798	
	H 14*		570310	
	H 16*		570320	
	H 18*		570340	
	H 20*		570350	
	H 26*		570370	
	H 32		570380	
	H 40 (PZ-4G)		570390	
	U 14*		570760	
	U 16*		570765	
	U 18*		570770	
	U 20*		570775	
	U 25*		570780	
U 32		570785		
U 40		570790		
U 50		570795		
U 63 (PR-3B)	Z4	572837		
U 63 (PZ-S)		572365		
F.B.Q. BARONIO BQ PRESS SOLAR	V 12		570107	
	V 15		570115	
	V 18		570125	
	V 22		570135	
	V 28		570145	
	V 35		570155	
	V 42		570165	
	V 42 (PR-2B)	Z2	572850	
	V 54		570175	
	V 54 (PR-2B)	Z2	572851	
	V 12 S (PR-2B)	Z8	574748	
	V 15 S (PR-2B)	Z8	574752	
	V 18 S (PR-2B)	Z8	574756	
	V 22 S (PR-2B)	Z8	574758	
	V 28 S (PR-2B)	Z8	574760	
	V 35 S (PR-2B)	Z8	574762	
	F.B.Q. BARONIO BQ PRESS WATER	V 12		570107
		V 15		570115
		V 18		570125
		V 22		570135
V 28			570145	
V 35			570155	
V 42			570165	
V 42 (PR-2B)		Z2	572850	
V 54			570175	
V 54 (PR-2B)		Z2	572851	
V 12 S (PR-2B)		Z8	574748	
V 15 S (PR-2B)		Z8	574752	
V 18 S (PR-2B)		Z8	574756	
V 22 S (PR-2B)		Z8	574758	
V 28 S (PR-2B)		Z8	574760	
V 35 S (PR-2B)		Z8	574762	
F.B.Q. BARONIO BQ PRESS C-STEEL		V 15		570115
		V 18		570125
		V 22		570135
		V 28		570145
	V 35		570155	
	V 42		570165	
	V 42 (PR-2B)	Z2	572850	
	V 54		570175	
	V 54 (PR-2B)	Z2	572851	
	V 15 S (PR-2B)	Z8	574752	
	V 18 S (PR-2B)	Z8	574756	
	V 22 S (PR-2B)	Z8	574758	
	V 28 S (PR-2B)	Z8	574760	
	V 35 S (PR-2B)	Z8	574762	

System	Pressing tongs / pressing rings	Driven by adapter tongs	Art.-No.
F.B.Q. BARONIO BQ PRESS GAS	V 12		570107
	V 15		570115
	V 18		570125
	V 22		570135
	V 28		570145
	V 35		570155
	V 42		570165
	V 42 (PR-2B)	Z2	572850
	V 54		570175
	V 54 (PR-2B)	Z2	572851
	V 12 S (PR-2B)	Z8	574748
	V 15 S (PR-2B)	Z8	574752
	V 18 S (PR-2B)	Z8	574756
	V 22 S (PR-2B)	Z8	574758
V 28 S (PR-2B)	Z8	574760	
V 35 S (PR-2B)	Z8	574762	
Fercofloor DUO Press FERCO PEX	Rfz 16*		571325
	Rfz 20*		571330
	Rfz 25		571335
	Rfz 32		571340
	TH 16*		570460
	TH 20*		570470
	TH 25*		570495
	TH 32		570480
	TH 40		570485
	TH 50 (PZ-S)		572400
Fercofloor DUO Press MULTIFER	TH 63 (PZ-S)		572405
	TH 16 S (PR-2B)	Z8	574782
	TH 20 S (PR-2B)	Z8	574788
	TH 32 S (PR-2B)	Z8	574798
	Rfz 16*		571325
	Rfz 20*		571330
	Rfz 25		571335
	Rfz 32		571340
	TH 16*		570460
	TH 20*		570470
FERRO systems BRASELLI GPF GAS	TH 25*		570495
	TH 32		570480
	TH 40		570485
	TH 50 (PZ-S)		572400
	TH 63 (PZ-S)		572405
	TH 16 S (PR-2B)	Z8	574782
	TH 20 S (PR-2B)	Z8	574788
	TH 32 S (PR-2B)	Z8	574798
	U 16*		570765
	U 18*		570770
FERRO systems BRASELLI GPF MULT Pressfitting MULTICAPA	U 20*		570775
	U 25*		570780
	U 32		570785
	U 40		570790
	U 50		570795
	U 63 (PZ-S)		572365
	TH 16*		570460
	TH 20*		570470
	TH 25*		570495
	TH 32		570480
FERRO systems BRASELLI GPF PPSU Pressfitting PEX y MULTICAPA	TH 16 S (PR-2B)	Z8	574782
	TH 20 S (PR-2B)	Z8	574788
	TH 32 S (PR-2B)	Z8	574798
	U 16*		570765
	U 18*		570770
	U 20*		570775
	U 25*		570780
	U 32		570785
	U 40		570790
	U 50		570795
FERRO systems BRASELLI GPF PRESS Pressfitting PEX	Rfz 16*		571325
	Rfz 20*		571330
	Rfz 25		571335
	Rfz 32		571340
	FTB 15		571432
	Fitpress FTB 18		571434
	FTB 22		571436
	FTB 28		571438
	M 42 (PR-3S)	Z2	572706
	M 54 (PR-3S)	Z2	572708
FILINOX Instalpress Steel	M 76,1 XL (PR-3S)	Z7 XL 45 kN ⁴⁾	579101
	M 88,9 G XL (PR-3S)	Z7 XL 45 kN ⁴⁾	579110
	M 108,0 G XL (PR-3S)	Z7 XL 45 kN ⁴⁾	579111
	M 15		570110
	M 18		570120
	M 22		570130
	M 28		570140
	M 35		570150
	M 42 (PR-3S)	Z2	572706
	M 54 (PR-3S)	Z2	572708

REMS pressing tongs REMS pressing rings

Accessories for REMS radial presses (except for REMS Mini-Press) and suitable radial presses of other makes

System	Pressing tongs / pressing rings	Driven by adapter tongs	Art.-No.
FILINOX Instalpress Inox	M 15		570110
	M 18		570120
	M 22		570130
	M 28		570140
	M 35		570150
	M 42 (PR-3S)	Z2	572706
	M 54 (PR-3S)	Z2	572708
	M 76.1 XL (PR-3S)	Z7 XL 45 kN ⁽⁴⁾	579101
	M 88.9 G XL (PR-3S)	Z7 XL 45 kN ⁽⁴⁾	579110
	M 108.0 G XL (PR-3S)	Z7 XL 45 kN ⁽⁴⁾	579111
	M 15 S (PR-2B)	Z8	574738
	M 18 S (PR-2B)	Z8	574740
	M 22 S (PR-2B)	Z8	574742
	M 28 S (PR-2B)	Z8	574744
	M 35 S (PR-2B)	Z8	574746
	Fittings Estándar ECO-PRESS	Rfz 16*	
Rfz 20*			571330
Rfz 25			571335
Rfz 32			571340
Fittings Estándar MULTICAPA	Rfz 16*		571325
	Rfz 18*		571327
	Rfz 20*		571330
	Rfz 25		571335
Rfz 32		571340	
Fittings Estándar PE-X	Rfz 16*		571325
	Rfz 20*		571330
	Rfz 25		571335
	Rfz 32		571340
FORNARA ForPress	B 16*		570850
	B 20*		570860
	B 26		570870
	B 32		570880
	F 16*		570717
	F 20*		570727
	F 26*		570730
	F 32		570735
	F 16 S (PR-2B)	Z8	574728
	F 20 S (PR-2B)	Z8	574730
	F 26 S (PR-2B)	Z8	574732
	F 32 S (PR-2B)	Z8	574734
	H 16*		570320
	H 20*		570350
	H 26*		570370
	H 32		570380
	TH 16*		570460
	TH 20*		570470
	TH 26*		570475
	TH 32		570480
	TH 16 S (PR-2B)	Z8	574782
	TH 20 S (PR-2B)	Z8	574788
	TH 26 S (PR-2B)	Z8	574794
	TH 32 S (PR-2B)	Z8	574798
	U 16*		570765
	U 20*		570775
	C 26*		570750
U 32		570785	
FORZA WATER CRIMP (AUS)	K16/P18*		572600
	K/20*		572605
	K/25*		572610
	K32		572615
	K1/40		572620
	K1/50		572625
FORZA STAINLESS WATER CRIMP	K16/P18*		572600
	K/20*		572605
FORZA STESSO PEX WATER AND GAS CRIMP (AUS)	U 16*		570765
	U 20*		570775
	U 25*		570780
	U 32		570785
	U 40		570790
	U 50		570795
	U 63 (PZ-S)		572365
FORZA GAS CRIMP (AUS)	K16/P18*		572600
	K/20*		572605
	K/25*		572610
	K32		572615
	K1/40		572620
K1/50		572625	

System	Pressing tongs / pressing rings	Driven by adapter tongs	Art.-No.
FORZA COPPER V PRESS (AUS)	VAU 15 (OD 12,7 mm)		572687
	VAU 20 (OD 19,1 mm)		572689
	VAU 25 (OD 25,4 mm)		572691
	VAU 32 (OD 31,8 mm)		572693
	VAU 40 (OD 38,1 mm)		572695
	VAU 50 (OD 50,8 mm)		572697
	VAUFz 65 (PR-3B) (OD 63,5 mm)	Z5	572839
	VAUFz 80 (PR-3B) (OD 76,2 mm)	Z5	572840
	VAUFz 100 (PR-3B) (OD 101,6 mm)	Z5	572841
	VAU 15 S (PR-2B) (OD 12,7 mm)	Z8	574804
VAU 20 S (PR-2B) (OD 19,1 mm)	Z8	574806	
VAU 25 S (PR-2B) (OD 25,4 mm)	Z8	574808	
FORZA STAINLESS V PRESS (AUS)	V 15		570115
	V 22		570135
	V 28		570145
	V 35		570155
	V 42		570165
	V 54		570175
	M 76.1 XL (PR-3S)	Z6 XL ⁽³⁾ / Z7 XL 45 kN ⁽⁴⁾	579101
	M 88.9 G XL (PR-3S)	Z6 XL ⁽³⁾ / Z7 XL 45 kN ⁽⁴⁾	579110
	M 108.0 G XL (PR-3S)	Z6 XL ⁽³⁾ / Z7 XL 45 kN ⁽⁴⁾	579111
	V 15 S (PR-2B)	Z8	574752
V 22 S (PR-2B)	Z8	574758	
V 28 S (PR-2B)	Z8	574760	
V 35 S (PR-2B)	Z8	574762	
FRABO FRABOPRESS 316 GAS M	M 15		570110
	M 18		570120
	M 22		570130
	M 28		570140
	M 35		570150
	M 42 (PR-3S)	Z2	572706
	M 54 (PR-3S)	Z2	572708
	M 15 S (PR-2B)	Z8	574738
	M 18 S (PR-2B)	Z8	574740
	M 22 S (PR-2B)	Z8	574742
M 28 S (PR-2B)	Z8	574744	
M 35 S (PR-2B)	Z8	574746	
FRABO FRABOPRESS 316 GAS V	V 15		570115
	V 18		570125
	V 22		570135
	V 28		570145
	V 35		570155
	V 42		570165
	V 42 (PR-2B)	Z2	572850
	V 54		570175
	V 54 (PR-2B)	Z2	572851
	V 15 S (PR-2B)	Z8	574752
V 18 S (PR-2B)	Z8	574756	
V 22 S (PR-2B)	Z8	574758	
V 28 S (PR-2B)	Z8	574760	
V 35 S (PR-2B)	Z8	574762	
FRABO FRABOPRESS 316 M	M 15		570110
	M 18		570120
	M 22		570130
	M 28		570140
	M 35		570150
	M 42 (PR-3S)	Z2	572706
	M 54 (PR-3S)	Z2	572708
	M 66.7 XL (PR-3S)	Z6 XL ⁽³⁾ / Z7 XL 45 kN ⁽⁴⁾	579107
	M 76.1 XL (PR-3S)	Z6 XL ⁽³⁾ / Z7 XL 45 kN ⁽⁴⁾	579101
	M 88.9 G XL (PR-3S)	Z6 XL ⁽³⁾ / Z7 XL 45 kN ⁽⁴⁾	579110
M 108.0 G XL (PR-3S)	Z6 XL ⁽³⁾ / Z7 XL 45 kN ⁽⁴⁾	579111	
M 15 S (PR-2B)	Z8	574738	
M 18 S (PR-2B)	Z8	574740	
M 22 S (PR-2B)	Z8	574742	
M 28 S (PR-2B)	Z8	574744	
M 35 S (PR-2B)	Z8	574746	
FRABO FRABOPRESS 316 V	V 15		570115
	V 18		570125
	V 22		570135
	V 28		570145
	V 35		570155
	V 42		570165
	V 42 (PR-2B)	Z2	572850
	V 54		570175
	V 54 (PR-2B)	Z2	572851
	V 15 S (PR-2B)	Z8	574752
V 18 S (PR-2B)	Z8	574756	
V 22 S (PR-2B)	Z8	574758	
V 28 S (PR-2B)	Z8	574760	
V 35 S (PR-2B)	Z8	574762	

Pressfitting systems for gas installations must only be pressed with pressing tongs/pressing rings which are highlighted in yellow.

Observe the national regulations. Read and observe the instructions for use and the installation instructions of the system provider/manufacturer.

* These pressing tongs also fit the manual radial press REMS Eco-Press. Observe the national regulations.

- 1) Only pressing tongs from designation "108" (1st quarter of 2008), "208" (2nd quarter of 2008) etc. can be used. The designation is stamped on every pressing jaw.
- 2) For this pressfitting system producing a pressing joint with manual radial presses is not permitted.
- 3) Driven by REMS Power-Press XL ACC.
- 4) Driven by REMS Akku-Press XL 45 kN 22 V ACC.
- 5) For taking suitable pressing inserts.
- 6) Press fittings made of red bronze (Sanpress XL) must be pressed with pressing rings with press contour VR, copper fittings (Profipress XL, Profipress G XL), carbon steel (Prestabo XL) and stainless steel fittings (Sanpress Inox XL, Sanpress Inox G XL) with pressing rings with press contour VF.
- 7) Use pressing rings labelled "M 88.9 G" or "M 108 G" on the three pressing segments for gas installations.
- 8) For making press joints for operating pressure ≤ PN 10.
- 9) For pipes of the EN technical standard. Observe the instructions for use of the system provider/manufacturer.
- 10) For pipes of the ASTM technical standard. Observe the instructions for use of the system provider/manufacturer.

The suitability of REMS pressing tools for pressfitting systems: Date 12.10.2022. For the updated situation regarding suitability status check our website: www.rems.de > Downloads > Product catalogues, brochures > REMS Catalogue.

See page 236 for adapter tongs. Pressing tongs/pressing rings for additional pressfitting systems on request.

REMS pressing tongs

REMS pressing rings

Accessories for REMS radial presses (except for REMS Mini-Press) and suitable radial presses of other makes

System	Pressing tongs / pressing rings	Driven by adapter tongs	Art.-No.
FRABO FRABOPRESS CHROME	V 12		570107
	V 15		570115
	V 18		570125
	V 22		570135
	V 12 S (PR-2B)	Z8	574748
	V 15 S (PR-2B)	Z8	574752
	V 18 S (PR-2B)	Z8	574756
V 22 S (PR-2B)	Z8	574758	
FRABO FRABOPRESS C-STEEL M	M 15		570110
	M 18		570120
	M 22		570130
	M 28		570140
	M 35		570150
	M 42 (PR-3S)	Z2	572706
	M 54 (PR-3S)	Z2	572708
	M 66,7 XL (PR-3S)	Z6 XL ³⁾ / Z7 XL 45 kN ⁴⁾	579107
	M 76,1 XL (PR-3S)	Z6 XL ³⁾ / Z7 XL 45 kN ⁴⁾	579101
	M 88,9 G XL (PR-3S)	Z6 XL ³⁾ / Z7 XL 45 kN ⁴⁾	579110
	M 108,0 G XL (PR-3S)	Z6 XL ³⁾ / Z7 XL 45 kN ⁴⁾	579111
	M 15 S (PR-2B)	Z8	574738
	M 18 S (PR-2B)	Z8	574740
	M 22 S (PR-2B)	Z8	574742
	M 28 S (PR-2B)	Z8	574744
M 35 S (PR-2B)	Z8	574746	
FRABO FRABOPRESS C-STEEL V	V 12		570107
	V 15		570115
	V 18		570125
	V 22		570135
	V 28		570145
	V 35		570155
	V 42		570165
	V 42 (PR-2B)	Z2	572850
	V 54		570175
	V 54 (PR-2B)	Z2	572851
	V 12 S (PR-2B)	Z8	574748
	V 15 S (PR-2B)	Z8	574752
	V 18 S (PR-2B)	Z8	574756
	V 22 S (PR-2B)	Z8	574758
	V 28 S (PR-2B)	Z8	574760
V 35 S (PR-2B)	Z8	574762	
FRABO FRABOPRESS GAS M	M 12		570100
	M 15		570110
	M 18		570120
	M 22		570130
	M 28		570140
	M 35		570150
	M 42 (PR-3S)	Z2	572706
	M 54 (PR-3S)	Z2	572708
	M 12 S (PR-2B)	Z8	574736
	M 15 S (PR-2B)	Z8	574738
	M 18 S (PR-2B)	Z8	574740
	M 22 S (PR-2B)	Z8	574742
	M 28 S (PR-2B)	Z8	574744
	M 35 S (PR-2B)	Z8	574746
	FRABO FRABOPRESS GAS V	V 12	
V 15			570115
V 18			570125
V 22			570135
V 28			570145
V 35			570155
V 42			570165
V 42 (PR-2B)		Z2	572850
V 54			570175
V 54 (PR-2B)		Z2	572851
V 12 S (PR-2B)		Z8	574748
V 15 S (PR-2B)		Z8	574752
V 18 S (PR-2B)		Z8	574756
V 22 S (PR-2B)		Z8	574758
V 28 S (PR-2B)		Z8	574760
V 35 S (PR-2B)	Z8	574762	
FRABO FRABOPRESS KOMBI	V 12		570107
	V 15		570115
	V 18		570125
	V 22		570135
	V 28		570145
	V 35		570155
	V 42		570165
	V 42 (PR-2B)	Z2	572850
	V 54		570175
	V 54 (PR-2B)	Z2	572851
	M 66,7 XL (PR-3S)	Z6 XL ³⁾ / Z7 XL 45 kN ⁴⁾	579107
	M 76,1 XL (PR-3S)	Z6 XL ³⁾ / Z7 XL 45 kN ⁴⁾	579101
	M 88,9 G XL (PR-3S)	Z6 XL ³⁾ / Z7 XL 45 kN ⁴⁾	579110
	M 108,0 G XL (PR-3S)	Z6 XL ³⁾ / Z7 XL 45 kN ⁴⁾	579111
	V 12 S (PR-2B)	Z8	574748
V 15 S (PR-2B)	Z8	574752	
V 18 S (PR-2B)	Z8	574756	
V 22 S (PR-2B)	Z8	574758	
V 28 S (PR-2B)	Z8	574760	
V 35 S (PR-2B)	Z8	574762	
FRABO FRABOPRESS M	M 12		570100
	M 15		570110
	M 18		570120
	M 22		570130
	M 28		570140
	M 35		570150
	M 42 (PR-3S)	Z2	572706
	M 54 (PR-3S)	Z2	572708
	M 66,7 XL (PR-3S)	Z6 XL ³⁾ / Z7 XL 45 kN ⁴⁾	579107
	M 76,1 XL (PR-3S)	Z6 XL ³⁾ / Z7 XL 45 kN ⁴⁾	579101
	M 88,9 G XL (PR-3S)	Z6 XL ³⁾ / Z7 XL 45 kN ⁴⁾	579110
	M 108,0 G XL (PR-3S)	Z6 XL ³⁾ / Z7 XL 45 kN ⁴⁾	579111
	M 12 S (PR-2B)	Z8	574736
	M 15 S (PR-2B)	Z8	574738
	M 18 S (PR-2B)	Z8	574740
M 22 S (PR-2B)	Z8	574742	
M 28 S (PR-2B)	Z8	574744	
M 35 S (PR-2B)	Z8	574746	

System	Pressing tongs / pressing rings	Driven by adapter tongs	Art.-No.	
FRABO FRABOPRESS SOLAR	V 15		570115	
	V 18		570125	
	V 22		570135	
	V 28		570145	
	V 35		570155	
	V 15 S (PR-2B)	Z8	574752	
	V 18 S (PR-2B)	Z8	574756	
V 22 S (PR-2B)	Z8	574758		
V 28 S (PR-2B)	Z8	574760		
V 35 S (PR-2B)	Z8	574762		
FRABO FRABOPRESS V	V 12		570107	
	V 15		570115	
	V 18		570125	
	V 22		570135	
	V 28		570145	
	V 35		570155	
	V 42		570165	
	V 42 (PR-2B)	Z2	572850	
	V 54		570175	
	V 54 (PR-2B)	Z2	572851	
	V 12 S (PR-2B)	Z8	574748	
	V 15 S (PR-2B)	Z8	574752	
V 18 S (PR-2B)	Z8	574756		
V 22 S (PR-2B)	Z8	574758		
V 28 S (PR-2B)	Z8	574760		
V 35 S (PR-2B)	Z8	574762		
Fränkische alpex-duo XS	F 16*		570717	
	F 20*		570727	
	F 26*		570730	
	F 32		570735	
	F 16 S (PR-2B)	Z8	574728	
	F 20 S (PR-2B)	Z8	574730	
	F 26 S (PR-2B)	Z8	574732	
	F 32 S (PR-2B)	Z8	574734	
	TH 16*		570460	
	TH 20*		570470	
	TH 26*		570475	
	TH 32		570480	
	TH 16 S (PR-2B)	Z8	574782	
	TH 20 S (PR-2B)	Z8	574788	
	TH 26 S (PR-2B)	Z8	574794	
TH 32 S (PR-2B)	Z8	574798		
Fränkische alpex F50 PROFI	F 16*		570717	
	F 20*		570727	
	F 26*		570730	
	F 32		570735	
	F 16 S (PR-2B)	Z8	574728	
	F 20 S (PR-2B)	Z8	574730	
	F 26 S (PR-2B)	Z8	574732	
	F 32 S (PR-2B)	Z8	574734	
	H 16*		570320	
	H 20*		570350	
	H 26*		570370	
	H 32		570380	
	TH 16*		570460	
	TH 20*		570470	
	TH 26*		570475	
TH 32		570480		
TH 16 S (PR-2B)	Z8	574782		
TH 20 S (PR-2B)	Z8	574788		
TH 26 S (PR-2B)	Z8	574794		
TH 32 S (PR-2B)	Z8	574798		
(DN 26)	U 16*		570765	
	U 20*		570775	
	U 25*		570780	
	U 32		570785	
	VP 16*		570910	
	VP 20*		570915	
	VP 32		570925	
	Fränkische alpex L	Fz 40		570742
		Fz 50		570747
		F 63 (PZ-S)		572385
Fz 75 (PR-3B)		Z4	572830	
G				
gabotherm H+S	TH 10*		570467	
	TH 12*		570452	
	TH 14*		570455	
	TH 15*		570457	
	TH 16*		570460	
	TH 17*		570462	
	TH 18*		570465	
	TH 20*		570470	
	TH 25*		570495	
	TH 26*		570475	
	TH 32		570480	
	TH 40		570485	
TH 50 (PZ-S)		572400		
TH 63 (PZ-S)		572405		
TH 16 S (PR-2B)	Z8	574782		
TH 20 S (PR-2B)	Z8	574788		
TH 26 S (PR-2B)	Z8	574794		
TH 32 S (PR-2B)	Z8	574798		
Gallagher USA YogaPipe ACR	H 12* (¼")		570300	
	U 14* (⅜")		570760	
	U 16* (½")		570765	
	U 18* (⅝")		570770	
	U 20* (¾")		570775	
	U 25* (⅞")		570780	
	U 32 (1⅞")		570785	

REMS pressing tongs REMS pressing rings

Accessories for REMS radial presses (except for REMS Mini-Press) and suitable radial presses of other makes

System	Pressing tongs / pressing rings	Driven by adapter tongs	Art.-No.
Geberit Mapress C-STAHL	M 12		570100
	M 15		570110
	M 18		570120
	M 22		570130
	M 28		570140
	M 35		570150
	M 35 (PR-3S)	Z2	572727
	M 42 (PZ-4G)		570160
	M 54 (PZ-4G)		570170
	M 42 (PR-3S)	Z2	572706
	M 54 (PR-3S)	Z2	572708
	M 66,7 XL (PR-3S)	26 XL ²⁾ / 27 XL 45 kN ⁴⁾	579107
	M 76,1 XL (PR-3S)	26 XL ²⁾ / 27 XL 45 kN ⁴⁾	579101
	M 88,9 G XL (PR-3S)	26 XL ²⁾ / 27 XL 45 kN ⁴⁾	579110
	M 108,0 G XL (PR-3S)	26 XL ²⁾ / 27 XL 45 kN ⁴⁾	579111
	M 12 S (PR-2B)	Z8	574736
	M 15 S (PR-2B)	Z8	574738
	M 18 S (PR-2B)	Z8	574740
	M 22 S (PR-2B)	Z8	574742
	M 28 S (PR-2B)	Z8	574744
	M 35 S (PR-2B)	Z8	574746
Geberit Mapress Edeltstahl	M 12		570100
	M 15		570110
	M 18		570120
	M 22		570130
	M 28		570140
	M 35		570150
	M 35 (PR-3S)	Z2	572727
	M 42 (PZ-4G)		570160
	M 54 (PZ-4G)		570170
	M 42 (PR-3S)	Z2	572706
	M 54 (PR-3S)	Z2	572708
	M 76,1 XL (PR-3S)	26 XL ²⁾ / 27 XL 45 kN ⁴⁾	579101
	M 88,9 G XL (PR-3S)	26 XL ²⁾ / 27 XL 45 kN ⁴⁾	579110
	M 108,0 G XL (PR-3S)	26 XL ²⁾ / 27 XL 45 kN ⁴⁾	579111
	M 12 S (PR-2B)	Z8	574736
	M 15 S (PR-2B)	Z8	574738
	M 18 S (PR-2B)	Z8	574740
	M 22 S (PR-2B)	Z8	574742
	M 28 S (PR-2B)	Z8	574744
	M 35 S (PR-2B)	Z8	574746
	Geberit Mapress Edeltstahl Gas	M 15	
M 18			570120
M 22			570130
M 28			570140
M 35			570150
M 35 (PR-3S)		Z2	572727
M 42 (PR-3S)		Z2	572706
M 54 (PR-3S)		Z2	572708
M 76,1 XL (PR-3S)		27 XL 45 kN ⁴⁾	579101
M 88,9 G XL (PR-3S) ⁷⁾		27 XL 45 kN ⁴⁾	579110
M 108,0 G XL (PR-3S) ⁷⁾		27 XL 45 kN ⁴⁾	579111
M 15 S (PR-2B)		Z8	574738
M 18 S (PR-2B)		Z8	574740
M 22 S (PR-2B)		Z8	574742
M 28 S (PR-2B)		Z8	574744
M 35 45° (P R-2B)	Z8	574746	
Geberit Mapress Kupfer	M 12		570100
	M 15		570110
	M 18		570120
	M 22		570130
	M 28		570140
	M 35		570150
	M 35 (PR-3S)	Z2	572727
	M 42 (PZ-4G)		570160
	M 54 (PZ-4G)		570170
	M 42 (PR-3S)	Z2	572706
	M 54 (PR-3S)	Z2	572708
	M 66,7 XL (PR-3S)	26 XL ²⁾ / 27 XL 45 kN ⁴⁾	579107
	M 76,1 XL (PR-3S)	26 XL ²⁾ / 27 XL 45 kN ⁴⁾	579101
	M 88,9 G XL (PR-3S)	26 XL ²⁾ / 27 XL 45 kN ⁴⁾	579110
	M 108,0 G XL (PR-3S)	26 XL ²⁾ / 27 XL 45 kN ⁴⁾	579111
	M 12 S (PR-2B)	Z8	574736
	M 15 S (PR-2B)	Z8	574738
	M 18 S (PR-2B)	Z8	574740
	M 22 S (PR-2B)	Z8	574742
	M 28 S (PR-2B)	Z8	574744
	M 35 S (PR-2B)	Z8	574746

System	Pressing tongs / pressing rings	Driven by adapter tongs	Art.-No.
Geberit Mapress Kupfer Gas	M 15		570110
	M 18		570120
	M 22		570130
	M 28		570140
	M 35		570150
	M 35 (PR-3S)	Z2	572727
	M 42 (PR-3S)	Z2	572706
	M 54 (PR-3S)	Z2	572708
	M 15 S (PR-2B)	Z8	574738
	M 18 S (PR-2B)	Z8	574740
	M 22 S (PR-2B)	Z8	574742
Geberit Mepla	G 16*		570400
	G 20*		570410
	G 26*		570420
	G 32		570430
	G 40		570440
	G 50		570450
	G 63 (PZ-S)		572470
Geberit Mepla Therm	G 16*		570400
	G 20*		570410
Geberit Volex	TH 16*		570460
	TH 20*		570470
	TH 26*		570475
General Fittings 5T00	H 16*		570320
	H 20*		570350
	H 26*		570370
	H 32		570380
	H 40 (PZ-4G)		570390
	TH 16*		570460
	TH 20*		570470
	TH 26*		570475
	TH 32		570480
	TH 40		570485
	TH 50 (PZ-S)		572400
	TH 63 (PZ-S)		572405
	TH 16 S (PR-2B)	Z8	574782
	TH 20 S (PR-2B)	Z8	574788
TH 26 S (PR-2B)	Z8	574794	
TH 32 S (PR-2B)	Z8	574798	
U 16*		570765	
U 20*		570775	
U 32		570785	
U 40		570790	
U 63 (PZ-S)		572365	
U 63 (PR-3B)	Z4	572837	
General Fittings Ewoprex	H 16*		570320
	H 20*		570350
	H 26*		570370
	H 32		570380
	TH 16*		570460
	TH 20*		570470
	TH 26*		570475
	TH 32		570480
	TH 40		570485
	TH 50 (PZ-S)		572400
	TH 63 (PZ-S)		572405
	TH 16 S (PR-2B)	Z8	574782
	TH 20 S (PR-2B)	Z8	574788
TH 26 S (PR-2B)	Z8	574794	
TH 32 S (PR-2B)	Z8	574798	
U 16*		570765	
U 20*		570775	
U 32		570785	
U 40		570790	
U 63 (PZ-S)		572365	

Pressfitting systems for gas installations must only be pressed with pressing tongs/pressing rings which are highlighted in yellow.

Observe the national regulations. Read and observe the instructions for use and the installation instructions of the system provider/manufacturer.

* These pressing tongs also fit the manual radial press REMS Eco-Press. Observe the national regulations.

¹⁾ Only pressing tongs from designation "108" (1st quarter of 2008), "208" (2nd quarter of 2008) etc. can be used. The designation is stamped on every pressing jaw.

²⁾ For this pressfitting system producing a pressing joint with manual radial presses is not permitted.

³⁾ Driven by REMS Power-Press XL ACC.

⁴⁾ Driven by REMS Akku-Press XL 45 kN 22 V ACC.

⁵⁾ For taking suitable pressing inserts.

⁶⁾ Press fittings made of red bronze (Sanpress XL) must be pressed with pressing rings with press contour VR, copper fittings (Profipress XL, Profipress G XL), carbon steel (Prestabo XL) and stainless steel fittings (Sanpress Inox XL, Sanpress Inox G XL) with pressing rings with press contour VF.

⁷⁾ Use pressing rings labelled "M 88.9 G" or "M 108 G" on the three pressing segments for gas installations.

⁸⁾ For making press joints for operating pressure ≤ PN 10.

⁹⁾ For pipes of the EN technical standard. Observe the instructions for use of the system provider/manufacturer.

¹⁰⁾ For pipes of the ASTM technical standard. Observe the instructions for use of the system provider/manufacturer.

The suitability of REMS pressing tools for pressfitting systems: Date 12.10.2022. For the updated situation regarding suitability status check our website: www.rems.de > Downloads > Product catalogues, brochures > REMS Catalogue.

See page 236 for adapter tongs. Pressing tongs/pressing rings for additional pressfitting systems on request.

System	Pressing tongs / pressing rings	Driven by adapter tongs	Art.-No.	
General Fittings Serie 5S00	B 16*		570850	
	B 18*		570855	
	B 20*		570860	
	B 26		570870	
	B 32		570880	
	F 16*		570717	
	F 20*		570727	
	F 26*		570730	
	F 32		570735	
	F 16 S (PR-2B)	Z8	574728	
	F 20 S (PR-2B)	Z8	574730	
	F 26 S (PR-2B)	Z8	574732	
	F 32 S (PR-2B)	Z8	574734	
	H 16*		570320	
	H 18*		570340	
	H 20*		570350	
	H 25*		570360	
	H 26*		570370	
	H 32		570380	
	H 40 (PZ-4G)		570390	
	TH 16*		570460	
	TH 18*		570465	
	TH 20*		570470	
	TH 25*		570495	
	TH 26*		570475	
	TH 32		570480	
	TH 40		570485	
	TH 50 (PZ-S)		572400	
	TH 63 (PZ-S)		572405	
	TH 16 S (PR-2B)	Z8	574782	
	TH 20 S (PR-2B)	Z8	574788	
	TH 26 S (PR-2B)	Z8	574794	
	TH 32 S (PR-2B)	Z8	574798	
	U 16*		570765	
	U 18*		570770	
	U 20*		570775	
	U 25*		570780	
	U 32		570785	
	U 40		570790	
	U 63 (PZ-S)		572365	
	U 63 (PR-3B)	Z4	572837	
	General Fittings Trident	B 16*		570850
		F 16*		570717
F 16 S (PR-2B)		Z8	574728	
H 16*			570320	
H 20*			570350	
H 26*			570370	
H 32			570380	
TH 16*			570460	
TH 20*			570470	
TH 26*			570475	
TH 32			570480	
TH 16 S (PR-2B)		Z8	574782	
TH 20 S (PR-2B)		Z8	574788	
TH 26 S (PR-2B)		Z8	574794	
TH 32 S (PR-2B)		Z8	574798	
U 16*			570765	
U 20*			570775	
U 32		570785		
General Fittings Trident Gas	TH 16*		570460	
	TH 20*		570470	
	TH 26*		570475	
	TH 32		570480	
	TH 16 S (PR-2B)	Z8	574782	
	TH 20 S (PR-2B)	Z8	574788	
	TH 26 S (PR-2B)	Z8	574794	
	TH 32 S (PR-2B)	Z8	574798	
	H 16*		570320	
	H 20*		570350	
	H 26*		570370	
Giacomini Raccordi RM Giacomini	H 32		570380	
	TH 16*		570460	
	TH 20*		570470	
	TH 26*		570475	
	TH 32		570480	
	TH 40		570485	
	TH 50 (PZ-S)		572400	
	TH 63 (PZ-S)		572405	
	U 16*		570765	
	U 20*		570775	
	U 32		570785	
	U 40		570790	
	U 50		570795	
	U 63 (PZ-S)		572365	
	Giacomini RM MULTIGAS	H 16*		570320
H 20*			570350	
H 26*			570370	
H 32			570380	
TH 16*			570460	
TH 20*			570470	
TH 26*			570475	
TH 32			570480	
U 16*			570765	
U 20*			570775	
U 32			570785	

System	Pressing tongs / pressing rings	Driven by adapter tongs	Art.-No.	
Giacomini Valvole Giacomini serie R850V	V 15		570115	
	V 18		570125	
	V 22		570135	
	V 28		570145	
	V 35		570155	
	V 42		570165	
	V 54		570175	
	V 15 S (PR-2B)	Z8	574752	
	V 18 S (PR-2B)	Z8	574756	
	V 22 S (PR-2B)	Z8	574758	
	V 28 S (PR-2B)	Z8	574760	
	V 35 S (PR-2B)	Z8	574762	
	SA 15		570935	
	SA 18		570940	
	SA 22		570945	
	SA 28		570950	
	SA 35		570955	
	M 15		570110	
	M 18		570120	
	M 22		570130	
	M 28		570140	
	M 35		570150	
	M 15 S (PR-2B)	Z8	574738	
	M 18 S (PR-2B)	Z8	574740	
	M 22 S (PR-2B)	Z8	574742	
	M 28 S (PR-2B)	Z8	574744	
	M 35 S (PR-2B)	Z8	574746	
	Golan Pipe Systems (Scandinavia) Alu-Pres	U 16*		570765
		U 20*		570775
		U 25*		570780
		U 32		570785
U 40			570790	
U 50			570795	
U 63 (PZ-S)			572365	
U 63 (PR-3B)	Z4	572837		
U 75 (PR-3B)	Z4	572828		
Grinnell G-PRESS Copper Fittings	VUS ½" (OD 15,9 mm)		571770	
	VUS ¾" (OD 22,2 mm)		571775	
	VUS 1" (OD 28,6 mm)		571780	
	VUS 1 ¼" (OD 34,9 mm)		571785	
	VUS 1 ½" (OD 41,3 mm)		571790	
	VUS 2" (OD 54,0 mm)		571795	
	VUSFz 2 ½" (PR-3B) (OD 66,7 mm)	Z5	572819	
VUSFz 3" (PR-3B) (OD 79,4 mm)	Z5	572820		
VUSFz 4" (PR-3B) (OD 104,8 mm)	Z5	572821		
GS Wärmesysteme System TH	TH 14*		570455	
	TH 16*		570460	
	TH 20*		570470	
	TH 26*		570475	
	TH 32		570480	
	TH 40		570485	
	TH 50 (PZ-S)		572400	
	TH 63 (PZ-S)		572405	
	TH 16 S (PR-2B)	Z8	574782	
	TH 20 S (PR-2B)	Z8	574788	
	TH 26 S (PR-2B)	Z8	574794	
TH 32 S (PR-2B)	Z8	574798		
GS Wärmesysteme System V	V 15		570115	
	V 18		570125	
	V 22		570135	
	V 28		570145	
	V 35		570155	
	V 15 S (PR-2B)	Z8	574752	
	V 18 S (PR-2B)	Z8	574756	
	V 22 S (PR-2B)	Z8	574758	
	V 28 S (PR-2B)	Z8	574760	
	V 35 S (PR-2B)	Z8	574762	
	H			
HakaGerodur HAKASAN	TH 10*		570467	
	TH 11,6*		570482	
	TH 12*		570452	
	TH 14*		570455	
	TH 16*		570460	
	TH 17*		570462	
	TH 18*		570465	
	TH 20*		570470	
	TH 25*		570495	
	TH 26*		570475	
	TH 32		570480	
	TH 40		570485	
	TH 50 (PZ-S)		572400	
	TH 63 (PZ-S)		572405	
	TH 16 S (PR-2B)	Z8	574782	
	TH 20 S (PR-2B)	Z8	574788	
TH 26 S (PR-2B)	Z8	574794		
TH 32 S (PR-2B)	Z8	574798		
HASTINIK Hastinik/Hitpress	M 15		570110	
	M 18		570120	
	M 22		570130	
	M 28		570140	
	M 35		570150	
	M 42 (PZ-4G)		570160	
	M 54 (PZ-4G)		570170	
	M 42 (PR-3S)	Z2	572706	
	M 54 (PR-3S)	Z2	572708	
	M 76,1 XL (PR-3S)	Z6 XL ³⁾ / Z7 XL 45 kN ⁴⁾	579101	
	M 88,9 G XL (PR-3S)	Z6 XL ³⁾ / Z7 XL 45 kN ⁴⁾	579110	
	M 108,0 G XL (PR-3S)	Z6 XL ³⁾ / Z7 XL 45 kN ⁴⁾	579111	
	M 15 S (PR-2B)	Z8	574738	
	M 18 S (PR-2B)	Z8	574740	
	M 22 S (PR-2B)	Z8	574742	
M 28 S (PR-2B)	Z8	574744		
M 35 S (PR-2B)	Z8	574746		

REMS pressing tongs

REMS pressing rings

Accessories for REMS radial presses (except for REMS Mini-Press) and suitable radial presses of other makes

System	Pressing tongs/ pressing rings	Driven by adapter tongs	Art.-No.	
heima24	TH 16*		570460	
	TH 20*		570470	
	TH 26*		570475	
	TH 32		570480	
	TH 40		570485	
	TH 50 (PZ-S)		572400	
	TH 63 (PZ-S)		572405	
	TH 16 S (PR-2B)	Z8	574782	
	TH 20 S (PR-2B)	Z8	574788	
	TH 26 S (PR-2B)	Z8	574794	
	TH 32 S (PR-2B)	Z8	574798	
	U 16*		570765	
	U 20*		570775	
	U 25*		570780	
	U 32		570785	
	HELIROMA Klimapress	U 16*		570765
		U 18*		570770
U 20*			570775	
U 25*			570780	
U 32			570785	
U 40			570790	
U 50			570795	
U 63 (PR-3B)		Z4	572837	
U 63 (PZ-S)			572365	
U 75 (PR-3B)		Z4	572828	
HELIROMA Romapress	RFz 16*		571325	
	RFz 20*		571330	
	RFz 25		571335	
	RFz 32		571340	
Henco	TH 14*		570455	
	TH 16*		570460	
	TH 18*		570465	
	TH 20*		570470	
	TH 26*		570475	
	HE 32		571900	
	HEz 40		571904	
	Herotec TEMPUS-PRESS PLUS	H 16*		570320
H 20*			570350	
H 25*			570360	
H 32			570380	
H 40 (PZ-4G)			570390	
RFz 16*			571325	
RFz 20*			571330	
RFz 25			571335	
RFz 32			571340	
TH 16*			570460	
TH 20*			570470	
TH 25*			570495	
TH 32			570480	
TH 40			570485	
TH 50 (PZ-S)			572400	
TH 63 (PZ-S)			572405	
TH 16 S (PR-2B)		Z8	574782	
TH 20 S (PR-2B)		Z8	574788	
TH 32 S (PR-2B)		Z8	574798	
U 16*			570765	
U 20*			570775	
U 25*			570780	
U 32			570785	
U 40		570790		
U 50		570795		
U 63 (PZ-S)		572365		
U 63 (PR-3B)	Z4	572837		
U 75 (PR-3B)	Z4	572828		

System	Pressing tongs/ pressing rings	Driven by adapter tongs	Art.-No.
Herotec TEMPUS-PRESS PLUS PPSU	H 16*		570320
	H 20*		570350
	H 25*		570360
	H 32		570380
	TH 16*		570460
	TH 20*		570470
	TH 25*		570495
	TH 32		570480
	TH 40		570485
	TH 50 (PZ-S)		572400
	TH 63 (PZ-S)		572405
	TH 16 S (PR-2B)	Z8	574782
	TH 20 S (PR-2B)	Z8	574788
	TH 32 S (PR-2B)	Z8	574798
	U 16*		570765
	U 20*		570775
	U 25*		570780
U 32		570785	
U 40		570790	
U 50		570795	
U 63 (PZ-S)		572365	
U 63 (PR-3B)	Z4	572837	
U 75 (PR-3B)	Z4	572828	
HERZ PIPEFIX	TH 10*		570467
	TH 16*		570460
	TH 20*		570470
	TH 26*		570475
	TH 32		570480
	TH 40		570485
	TH 50 (PZ-S)		572400
	TH 63 (PZ-S)		572405
	THz 75 (PR-3B)	Z4	572829
	TH 16 S (PR-2B)	Z8	574782
	TH 20 S (PR-2B)	Z8	574788
TH 26 S (PR-2B)	Z8	574794	
TH 32 S (PR-2B)	Z8	574798	
HIDRONIX MULTIGAS	TH 16*		570460
	TH 20*		570470
	TH 26*		570475
HIDRONIX MULTIPIPE	TH 14*		570455
	TH 16*		570460
	TH 20*		570470
	TH 26*		570475
	TH 32		570480
	H 14*		570310
	H 16*		570320
	H 18*		570340
	H 20*		570350
	H 26*		570370
	H 32		570380
	U 14*		570760
	U 16*		570765
	U 18*		570770
U 20*		570775	
C 26*		570750	
U 32		570785	
HIDRONIX UNICO	TH 14*		570455
	TH 16*		570460
	TH 20*		570470
	TH 26*		570475
	TH 32		570480
	H 14*		570310
	H 16*		570320
	H 18*		570340
	H 20*		570350
	H 26*		570370
	H 32		570380
	U 14*		570760
	U 16*		570765
	U 18*		570770
U 20*		570775	
C 26*		570750	
U 32		570785	
HITEC Sistema Multistrato	TH 14*		570455
	TH 16*		570460
	TH 18*		570465
	TH 20*		570470
	TH 26*		570475
	TH 32		570480
	TH 40		570485
	TH 50 (PZ-S)		572400
	TH 16 S (PR-2B)	Z8	574782
	TH 20 S (PR-2B)	Z8	574788
	TH 26 S (PR-2B)	Z8	574794
TH 32 S (PR-2B)	Z8	574798	

Pressfitting systems for gas installations must only be pressed with pressing tongs/pressing rings which are highlighted in yellow.

Observe the national regulations. Read and observe the instructions for use and the installation instructions of the system provider/manufacturer.

* These pressing tongs also fit the manual radial press REMS Eco-Press. Observe the national regulations.

- Only pressing tongs from designation "108" (1st quarter of 2008), "208" (2nd quarter of 2008) etc. can be used. The designation is stamped on every pressing jaw.
- For this pressfitting system producing a pressing joint with manual radial presses is not permitted.
- Driven by REMS Power-Press XL ACC.
- Driven by REMS Akku-Press XL 45 kN 22 V ACC.
- For taking suitable pressing inserts.
- Press fittings made of red bronze (Sanpress XL) must be pressed with pressing rings with press contour VR, copper fittings (Profipress XL, Profipress G XL), carbon steel (Prestabo XL) and stainless steel fittings (Sanpress Inox XL, Sanpress Inox G XL) with pressing rings with press contour VF.
- Use pressing rings labelled "M 88.9 G" or "M 108 G" on the three pressing segments for gas installations.
- For making press joints for operating pressure \leq PN 10.
- For pipes of the EN technical standard. Observe the instructions for use of the system provider/manufacturer.
- For pipes of the ASTM technical standard. Observe the instructions for use of the system provider/manufacturer.

The suitability of REMS pressing tools for pressfitting systems: Date 12.10.2022. For the updated situation regarding suitability status check our website: www.rems.de > Downloads > Product catalogues, brochures > REMS Catalogue.

See page 236 for adapter tongs. Pressing tongs/pressing rings for additional pressfitting systems on request.

REMS pressing tongs REMS pressing rings

Accessories for REMS radial presses (except for REMS Mini-Press)
and suitable radial presses of other makes

System	Pressing tongs / pressing rings	Driven by adapter tongs	Art.-No.	
HITHERM-ISOTUBI NUMEPRESS	M 15		570110	
	M 18		570120	
	M 22		570130	
	M 28		570140	
	M 35		570150	
	M 42 (PR-3S)	Z2	572706	
	M 54 (PR-3S)	Z2	572708	
	M 76,1 XL (PR-3S)	Z6 XL ³⁾ / Z7 XL 45 kN ⁴⁾	579101	
	M 88,9 G XL (PR-3S)	Z6 XL ³⁾ / Z7 XL 45 kN ⁴⁾	579110	
	M 108,0 G XL (PR-3S)	Z6 XL ³⁾ / Z7 XL 45 kN ⁴⁾	579111	
	M 15 S (PR-2B)	Z8	574738	
	M 18 S (PR-2B)	Z8	574740	
	M 22 S (PR-2B)	Z8	574742	
	M 28 S (PR-2B)	Z8	574744	
	M 35 S (PR-2B)	Z8	574746	
	HITHERM HTpress	M 15		570110
		M 18		570120
		M 22		570130
		M 28		570140
		M 35		570150
M 42 (PR-3S)		Z2	572706	
M 54 (PR-3S)		Z2	572708	
M 76,1 XL (PR-3S)		Z6 XL ³⁾ / Z7 XL 45 kN ⁴⁾	579101	
M 88,9 G XL (PR-3S)		Z6 XL ³⁾ / Z7 XL 45 kN ⁴⁾	579110	
M 108,0 G XL (PR-3S)		Z6 XL ³⁾ / Z7 XL 45 kN ⁴⁾	579111	
M 15 S (PR-2B)		Z8	574738	
M 18 S (PR-2B)		Z8	574740	
M 22 S (PR-2B)		Z8	574742	
M 28 S (PR-2B)		Z8	574744	
M 35 S (PR-2B)		Z8	574746	
HITHERM HTfire		M 15		570110
		M 18		570120
		M 22		570130
		M 28		570140
		M 35		570150
	M 42 (PR-3S)	Z2	572706	
	M 54 (PR-3S)	Z2	572708	
	M 76,1 XL (PR-3S)	Z6 XL ³⁾ / Z7 XL 45 kN ⁴⁾	579101	
	M 88,9 G XL (PR-3S)	Z6 XL ³⁾ / Z7 XL 45 kN ⁴⁾	579110	
	M 108,0 G XL (PR-3S)	Z6 XL ³⁾ / Z7 XL 45 kN ⁴⁾	579111	
	M 15 S (PR-2B)	Z8	574738	
	M 18 S (PR-2B)	Z8	574740	
	M 22 S (PR-2B)	Z8	574742	
	M 28 S (PR-2B)	Z8	574744	
	M 35 S (PR-2B)	Z8	574746	
	HITHERM HTair	M 15		570110
		M 18		570120
		M 22		570130
		M 28		570140
		M 35		570150
M 42 (PR-3S)		Z2	572706	
M 54 (PR-3S)		Z2	572708	
M 76,1 XL (PR-3S)		Z6 XL ³⁾ / Z7 XL 45 kN ⁴⁾	579101	
M 88,9 G XL (PR-3S)		Z6 XL ³⁾ / Z7 XL 45 kN ⁴⁾	579110	
M 108,0 G XL (PR-3S)		Z6 XL ³⁾ / Z7 XL 45 kN ⁴⁾	579111	
M 15 S (PR-2B)		Z8	574738	
M 18 S (PR-2B)		Z8	574740	
M 22 S (PR-2B)		Z8	574742	
M 28 S (PR-2B)		Z8	574744	
M 35 S (PR-2B)		Z8	574746	
Hopewell press fit system		M 15		570110
		M 18		570120
		M 22		570130
		M 28		570140
		M 35		570150
	M 42 (PZ-4G)		570160	
	M 54 (PZ-4G)		570170	
	M 42 (PR-3S)	Z2	572706	
	M 54 (PR-3S)	Z2	572708	
	hp praski BAVARIA-press	TH 10*		570467
		TH 12*		570452
		TH 14*		570455
TH 16*			570460	
TH 17*			570462	
TH 20*			570470	
TH 25*			570495	
TH 26*			570475	
TH 32			570480	
TH 40			570485	
TH 16 S (PR-2B)		Z8	574782	
TH 20 S (PR-2B)		Z8	574788	
TH 26 S (PR-2B)		Z8	574794	
TH 32 S (PR-2B)		Z8	574798	
ICMA Sempiter		H 16*		570320
		H 20*		570350
	H 25*		570360	
	H 26*		570370	
	H 32		570380	
	H 40 (PZ-4G)		570390	
	TH 16*		570460	
	TH 20*		570470	
	TH 25*		570495	
	TH 26*		570475	
	TH 32		570480	
	TH 40		570485	
	TH 50 (PZ-S)		572400	
	TH 63 (PZ-S)		572405	
	TH 16 S (PR-2B)	Z8	574782	
	TH 20 S (PR-2B)	Z8	574788	
	TH 26 S (PR-2B)	Z8	574794	
	TH 32 S (PR-2B)	Z8	574798	
	U 16*		570765	
	U 20*		570775	
	U 25*		570780	
	C 26*		570750	
	U 32		570785	
	U 40		570790	
	U 50		570795	
	U 63 (PR-3B)	Z4	572837	
	U 63 (PZ-S)		572365	

System	Pressing tongs / pressing rings	Driven by adapter tongs	Art.-No.	
ICMA Sempigas	TH 16*		570460	
	TH 20*		570470	
	TH 25*		570495	
	TH 26*		570475	
	TH 32		570480	
	TH 16 S (PR-2B)	Z8	574782	
	TH 20 S (PR-2B)	Z8	574788	
	TH 26 S (PR-2B)	Z8	574794	
	TH 32 S (PR-2B)	Z8	574798	
	Idrosanitaria Bonomi Homegas	TH 16*		570460
TH 20*			570470	
TH 26*			570475	
TH 16 S (PR-2B)		Z8	574782	
	TH 20 S (PR-2B)	Z8	574788	
	TH 26 S (PR-2B)	Z8	574794	
	Idrosanitaria Bonomi Idropress	TH 16*		570460
		TH 18*		570465
TH 20*			570470	
TH 26*			570475	
TH 32			570480	
TH 40			570485	
TH 50 (PZ-S)			572400	
TH 63 (PZ-S)			572405	
TH 16 S (PR-2B)		Z8	574782	
TH 20 S (PR-2B)		Z8	574788	
IDROSISTEMI Ta-Press	TH 16*		570460	
	TH 20*		570470	
	TH 26*		570475	
	TH 32		570480	
	TH 40		570485	
	TH 50 (PZ-S)		572400	
	TH 63 (PZ-S)		572405	
	TH 16 S (PR-2B)	Z8	574782	
	TH 20 S (PR-2B)	Z8	574788	
	TH 26 S (PR-2B)	Z8	574794	
	TH 32 S (PR-2B)	Z8	574798	
	F 16*		570717	
	F 20*		570727	
	F 26*		570730	
	F 32		570735	
	F 16 S (PR-2B)	Z8	574728	
	F 20 S (PR-2B)	Z8	574730	
	F 26 S (PR-2B)	Z8	574732	
	F 32 S (PR-2B)	Z8	574734	
	Fz 40		570742	
	Fz 50		570747	
	F 63 (PZ-S)		572385	
	H 16*		570320	
	H 20*		570350	
	H 26*		570370	
	H 32		570380	
	H 40 (PZ-4G)		570390	
	U 16*		570765	
	U 20*		570775	
	C 26*		570750	
U 32		570785		
U 40		570790		
U 50		570795		
U 63 (PZ-S)		572365		
IDROTRADE Storm Multipinza	B 16*		570850	
	B 20*		570860	
	B 26		570870	
	B 32		570880	
	H 16*		570320	
	H 20*		570350	
	H 26*		570370	
	H 32		570380	
	TH 16*		570460	
	TH 20*		570470	
IDROTRADE StormPRES ¹⁾	TH 26*		570475	
	TH 32		570480	
	THL 32		570487	
	TH 40		570485	
	TH 50 (PZ-S)		572400	
	TH 63 (PZ-S)		572405	
	TH 16 S (PR-2B)	Z8	574782	
	TH 20 S (PR-2B)	Z8	574788	
	TH 26 S (PR-2B)	Z8	574794	
	TH 32 S (PR-2B)	Z8	574798	
	U 16*		570765	
	U 20*		570775	
	M 15		570110	
	M 18		570120	
	M 22		570130	
	M 28		570140	
	M 35		570150	
	M 42 (PR-3S)	Z2	572706	
	M 54 (PR-3S)	Z2	572708	
	M 76,1 XL (PR-3S) ⁸⁾	Z7 XL 45 kN ⁴⁾	579101	
	M 88,9 G XL (PR-3S) ⁸⁾	Z7 XL 45 kN ⁴⁾	579110	
	M 108,0 G XL (PR-3S) ⁸⁾	Z7 XL 45 kN ⁴⁾	579111	
	M 15 S (PR-2B)	Z8	574738	
	M 18 S (PR-2B)	Z8	574740	
	M 22 S (PR-2B)	Z8	574742	
	M 28 S (PR-2B)	Z8	574744	
M 35 S (PR-2B)	Z8	574746		

REMS pressing tongs

REMS pressing rings

Accessories for REMS radial presses (except for REMS Mini-Press) and suitable radial presses of other makes

System	Pressing tongs / pressing rings	Driven by adapter tongs	Art.-No.	
IDROTRADE StormSTEEL ¹⁾	M 12		570100	
	M 15		570110	
	M 18		570120	
	M 22		570130	
	M 28		570140	
	M 35		570150	
	M 42 (PR-3S)	Z2	572706	
	M 54 (PR-3S)	Z2	572708	
	M 76.1 XL (PR-3S) ⁸⁾	Z7 XL 45 kN ⁴⁾	579101	
	M 88.9 G XL (PR-3S) ⁸⁾	Z7 XL 45 kN ⁴⁾	579110	
	M 108.0 G XL (PR-3S) ⁸⁾	Z7 XL 45 kN ⁴⁾	579111	
	M 12 S (PR-2B)	Z8	574736	
	M 15 S (PR-2B)	Z8	574738	
	M 18 S (PR-2B)	Z8	574740	
	M 22 S (PR-2B)	Z8	574742	
	M 28 S (PR-2B)	Z8	574744	
	M 35 S (PR-2B)	Z8	574746	
	ILTA INOX/CHIBRO Pressfitting Cuni	M 15		570110
		M 18		570120
		M 22		570130
		M 28		570140
M 35			570150	
M 42 (PR-3S)		Z2	572706	
M 54 (PR-3S)		Z2	572708	
M 76.1 XL (PR-3S)		Z6 XL ³⁾ / Z7 XL 45 kN ⁴⁾	579101	
M 88.9 G XL (PR-3S)		Z6 XL ³⁾ / Z7 XL 45 kN ⁴⁾	579110	
M 108.0 G XL (PR-3S)		Z6 XL ³⁾ / Z7 XL 45 kN ⁴⁾	579111	
M 15 S (PR-2B)		Z8	574738	
M 18 S (PR-2B)		Z8	574740	
M 22 S (PR-2B)		Z8	574742	
M 28 S (PR-2B)		Z8	574744	
M 35 S (PR-2B)		Z8	574746	
ILTA INOX/CHIBRO Pressfitting inox	M 15		570110	
	M 18		570120	
	M 22		570130	
	M 28		570140	
	M 35		570150	
	M 42 (PR-3S)	Z2	572706	
	M 54 (PR-3S)	Z2	572708	
	M 76.1 XL (PR-3S)	Z6 XL ³⁾ / Z7 XL 45 kN ⁴⁾	579101	
	M 88.9 G XL (PR-3S)	Z6 XL ³⁾ / Z7 XL 45 kN ⁴⁾	579110	
	M 108.0 G XL (PR-3S)	Z6 XL ³⁾ / Z7 XL 45 kN ⁴⁾	579111	
	M 15 S (PR-2B)	Z8	574738	
	M 18 S (PR-2B)	Z8	574740	
	M 22 S (PR-2B)	Z8	574742	
	M 28 S (PR-2B)	Z8	574744	
	M 35 S (PR-2B)	Z8	574746	
Instantor Press System	TH 16*		570460	
	TH 20*		570470	
	TH 26*		570475	
	TH 32		570480	
	TH 16 S (PR-2B)	Z8	574782	
	TH 20 S (PR-2B)	Z8	574788	
	TH 26 S (PR-2B)	Z8	574794	
	TH 32 S (PR-2B)	Z8	574798	
	Instantor Copper Press Metric	M 15		570110
M 22			570130	
M 28			570140	
M 15 S (PR-2B)		Z8	574738	
M 22 S (PR-2B)		Z8	574742	
M 28 S (PR-2B)		Z8	574746	
IPA IPANA Press	TH 10*		570467	
	TH 11.6*		570482	
	TH 12*		570452	
	TH 14*		570455	
	TH 15*		570457	
	TH 16*		570460	
	TH 17*		570462	
	TH 18*		570465	
	TH 20*		570470	
	TH 22*		570472	
	TH 25*		570495	
	TH 26*		570475	
	TH 28		570477	
	TH 32		570480	
	TH 40		570485	
	TH 50 (PZ-S)		572400	
	TH 63 (PZ-S)		572405	
	THz 75 (PR-3B)	Z4	572829	
	TH 16 S (PR-2B)	Z8	574782	
	TH 20 S (PR-2B)	Z8	574788	
	TH 26 S (PR-2B)	Z8	574794	
	TH 32 S (PR-2B)	Z8	574798	

System	Pressing tongs / pressing rings	Driven by adapter tongs	Art.-No.
IPA THu IPANA Press	TH 16*		570460
	TH 20*		570470
	TH 26*		570475
	TH 32		570480
	TH 40		570485
	TH 16 S (PR-2B)	Z8	574782
IPALPEX (Industrie du Plastique et Accessoires)	TH 14*		570455
	TH 16*		570460
	TH 18*		570465
	TH 20*		570470
	TH 26*		570475
	THL 32		570487
IPLEX PIPELINES AUSTRALIA Iplex Pro-fit	TH 50 (PZ-S)		572400
	TH 63 (PZ-S)		572405
	K16/P18*		572600
IPLEX PIPELINES AUSTRALIA Iplex K1 (Gas)	PF 22*		571980
	K16/P18*		572600
	K/20*		572605
	K/25*		572610
	K32		572615
	K1/40		572620
IPLEX PIPELINES AUSTRALIA Iplex K2	K1/50		572625
	K16/P18*		572600
	K/20*		572605
ISOLPEX IPERT	K/25*		572610
	RFz 16*		571325
	RFz 20*		571330
ISOLPEX Multicapa	RFz 25		571337
	RFz 32		571342
	RFz 16*		571325
ISOLPEX Multicapa GAS	RFz 18*		571327
	RFz 20*		571330
	RFz 25		571337
	RFz 32		571342
	U 16*		570765
	U 18*		570770
	U 20*		570775
	U 25*		570780
	U 32		570785
	U 40		570790
	U 50		570795
	U 63 (PR-3B)	Z4	572837
U 63 (PZ-S)		572365	
ISOLPEX Multicapa PPSU	RFz 16*		571325
	RFz 20*		571330
	RFz 25		571337
	RFz 32		571342
ISOTUBI NUMEPRESS	U 16*		570765
	U 20*		570775
	U 25*		570780
ISOTUBI NUMEPRESS	U 32		570785
	M 15		570110
	M 18 ¹⁾		570120
	M 22		570130
	M 28 ¹⁾		570140
	M 35		570150
	M 42 (PR-3S)	Z2	572706
	M 54 (PR-3S)	Z2	572708
	M 76.1 XL (PR-3S)	Z6 XL ³⁾ / Z7 XL 45 kN ⁴⁾	579101
	M 88.9 G XL (PR-3S)	Z6 XL ³⁾ / Z7 XL 45 kN ⁴⁾	579110
	M 108.0 G XL (PR-3S)	Z6 XL ³⁾ / Z7 XL 45 kN ⁴⁾	579111
	M 15 S (PR-2B)	Z8	574738
	M 18 S (PR-2B)	Z8	574740
	M 22 S (PR-2B)	Z8	574742
	M 28 S (PR-2B)	Z8	574744
M 35 S (PR-2B)	Z8	574746	
IVAR ALPEX-GAS	B 20		570860
	B 26		570870
	B 32		570880

Pressfitting systems for gas installations must only be pressed with pressing tongs/pressing rings which are highlighted in yellow.

Observe the national regulations. Read and observe the instructions for use and the installation instructions of the system provider/manufacturer.

* These pressing tongs also fit the manual radial press REMS Eco-Press. Observe the national regulations.

¹⁾ Only pressing tongs from designation "108" (1st quarter of 2008), "208" (2nd quarter of 2008) etc. can be used. The designation is stamped on every pressing jaw.

²⁾ For this pressfitting system producing a pressing joint with manual radial presses is not permitted.

³⁾ Driven by REMS Power-Press XL ACC.

⁴⁾ Driven by REMS Akku-Press XL 45 kN 22 V ACC.

⁵⁾ For taking suitable pressing inserts.

⁶⁾ Press fittings made of red bronze (Sanpress XL) must be pressed with pressing rings with press contour VR, copper fittings (Profipress XL, Profipress G XL), carbon steel (Prestabo XL) and stainless steel fittings (Sanpress Inox XL, Sanpress Inox G XL) with pressing rings with press contour VF.

⁷⁾ Use pressing rings labelled "M 88.9 G" or "M 108 G" on the three pressing segments for gas installations.

⁸⁾ For making press joints for operating pressure \leq PN 10.

⁹⁾ For pipes of the EN technical standard. Observe the instructions for use of the system provider/manufacturer.

¹⁰⁾ For pipes of the ASTM technical standard. Observe the instructions for use of the system provider/manufacturer.

The suitability of REMS pressing tools for pressfitting systems: Date 12.10.2022. For the updated situation regarding suitability status check our website: www.rems.de > Downloads > Product catalogues, brochures > REMS Catalogue.

See page 236 for adapter tongs. Pressing tongs/pressing rings for additional pressfitting systems on request.

System	Pressing tongs / pressing rings	Driven by adapter tongs	Art.-No.	
IVAR Ivar-Press	B 14*		570845	
	B 16*		570850	
	B 18*		570855	
	B 20*		570860	
	B 26		570870	
	B 32		570880	
	Fz 40		570742	
	Fz 50		570747	
	F 63 (PZ-S)		572385	
	IVAR MULTI PRESS GAS	TH 16*		570460
TH 20*			570470	
TH 26*			570475	
TH 32			570480	
B 16*			570850	
B 20*			570860	
B 26			570870	
IVAR MULTI PRESS GAS ITALIA	TH 16*		570460	
	TH 20*		570470	
	TH 26*		570475	
	H 16*		570320	
	H 20*		570350	
	H 26*		570370	
	U 16*		570765	
IVAR Multi Press MP	TH 16*		570460	
	TH 18*		570465	
	TH 20*		570470	
	TH 25*		570495	
	TH 26*		570475	
	TH 32		570480	
	TH 40		570485	
	TH 50 (PZ-S)		572400	
	TH 63 (PZ-S)		572405	
	TH 16 S (PR-2B)	Z8	574782	
	TH 20 S (PR-2B)	Z8	574788	
	TH 26 S (PR-2B)	Z8	574794	
	TH 32 S (PR-2B)	Z8	574798	
	F 16*		570717	
	F 18*		570720	
	F 20*		570727	
	F 26*		570730	
	F 32		570735	
	Fz 40		570742	
	Fz 50		570747	
	F 63 (PZ-S)		572385	
	F 16 S (PR-2B)	Z8	574728	
	F 20 S (PR-2B)	Z8	574730	
	F 26 S (PR-2B)	Z8	574732	
	F 32 S (PR-2B)	Z8	574734	
	H 16*		570320	
	H 18*		570340	
	H 20*		570350	
	H 25*		570360	
	H 26*		570370	
	H 32		570380	
	H 40 (PZ-4G)		570390	
	U 16*		570765	
	U 18*		570770	
	U 20*		570775	
	U 25*		570780	
	C 26*		570750	
	U 32		570785	
	U 40		570790	
	U 50		570795	
	U 63 (PZ-S)		572365	
	B 16*		570850	
	B 18*		570855	
	B 20*		570860	
	B 26		570870	
	B 32		570880	
	IVAR Multi Press Leak (MPL)	TH 16*		570460
		TH 20*		570470
		TH 26*		570475
		TH 32		570480
TH 16 S (PR-2B)		Z8	574782	
TH 20 S (PR-2B)		Z8	574788	
TH 26 S (PR-2B)		Z8	574794	
TH 32 S (PR-2B)		Z8	574798	
F 16*			570717	
F 20*			570727	
F 26*			570730	
F 32			570735	
F 16 S (PR-2B)		Z8	574728	
F 20 S (PR-2B)		Z8	574730	
F 26 S (PR-2B)		Z8	574732	
F 32 S (PR-2B)		Z8	574734	
H 16*			570320	
H 20*			570350	
H 26*			570370	
H 32			570380	
U 16*		570765		
U 20*		570775		
C 26*		570750		
U 32		570785		
B 16*		570850		
B 20*		570860		
B 26		570870		
B 32		570880		

System	Pressing tongs / pressing rings	Driven by adapter tongs	Art.-No.
IVAR Plastic Multi Press Leak (PMPL)	TH 16*		570460
	TH 20*		570470
	TH 26*		570475
	TH 32		570480
	TH 16 S (PR-2B)	Z8	574782
	TH 20 S (PR-2B)	Z8	574788
	TH 26 S (PR-2B)	Z8	574794
	TH 32 S (PR-2B)	Z8	574798
	F 16*		570717
	F 20*		570727
	F 26*		570730
	F 32		570735
	F 16 S (PR-2B)	Z8	574728
	F 20 S (PR-2B)	Z8	574730
	F 26 S (PR-2B)	Z8	574732
	F 32 S (PR-2B)	Z8	574734
	H 16*		570320
	H 20*		570350
	H 26*		570370
	IVAR Plastic Multi Press PMP	TH 16*	
TH 20*			570470
TH 25*			570495
TH 26*			570475
TH 32			570480
TH 16 S (PR-2B)		Z8	574782
TH 20 S (PR-2B)		Z8	574788
TH 26 S (PR-2B)		Z8	574794
TH 32 S (PR-2B)		Z8	574798
F 16*			570717
F 20*			570727
F 26*			570730
F 32			570735
F 16 S (PR-2B)		Z8	574728
F 20 S (PR-2B)		Z8	574730
F 26 S (PR-2B)		Z8	574732
F 32 S (PR-2B)		Z8	574734
H 16*			570320
H 20*			570350
H 25*			570360
H 26*		570370	
H 32		570380	
U 16*		570765	
U 20*		570775	
U 25*		570780	
C 26*		570750	
U 32		570785	
B 16*		570850	
B 20*		570860	
B 26		570870	
B 32		570880	
IVT Edelstahl- Presssystem	M 15		570110
	M 18 ¹⁾		570120
	M 22		570130
	M 28 ¹⁾		570140
	M 35		570150
	M 42 (PR-3S)	Z2	572706
	M 54 (PR-3S)	Z2	572708
	M 76,1 XL (PR-3S)	Z6 XL ²⁾ / Z7 XL 45 kN ³⁾	579101
	M 88,9 G XL (PR-3S)	Z6 XL ²⁾ / Z7 XL 45 kN ³⁾	579110
	M 108,0 G XL (PR-3S)	Z6 XL ²⁾ / Z7 XL 45 kN ³⁾	579111
	M 15 S (PR-2B)	Z8	574738
	M 18 S (PR-2B)	Z8	574740
	M 22 S (PR-2B)	Z8	574742
	M 28 S (PR-2B)	Z8	574744
	M 35 S (PR-2B)	Z8	574746
IVT PRIPRESS	TH 16*		570460
	TH 20*		570470
	TH 26*		570475
	TH 32		570480
	TH 40		570485
	TH 16 S (PR-2B)	Z8	574782
	TH 20 S (PR-2B)	Z8	574788
	TH 26 S (PR-2B)	Z8	574794
	TH 32 S (PR-2B)	Z8	574798
	J		
Jäger - Aquatec Aquatec H	H 14*		570310
	H 16*		570320
	H 17*		570330
	H 18*		570340
	H 20*		570350
	H 26*		570370
	H 32		570380
	U 40		570790
	U 50		570795
	U 63 (PZ-S)		572365
Jäger - Aquatec C-Stahl - Press Typ M	M 15		570110
	M 18		570120
	M 22		570130
	M 28		570140
	M 35		570150
	M 42 (PR-3S)	Z2	572706
	M 54 (PR-3S)	Z2	572708
	M 76,1 XL (PR-3S)	Z6 XL ²⁾ / Z7 XL 45 kN ³⁾	579101
	M 88,9 G XL (PR-3S)	Z6 XL ²⁾ / Z7 XL 45 kN ³⁾	579110
	M 108,0 G XL (PR-3S)	Z6 XL ²⁾ / Z7 XL 45 kN ³⁾	579111
	M 15 S (PR-2B)	Z8	574738
	M 18 S (PR-2B)	Z8	574740
	M 22 S (PR-2B)	Z8	574742
	M 28 S (PR-2B)	Z8	574744
	M 35 S (PR-2B)	Z8	574746

REMS pressing tongs

REMS pressing rings

Accessories for REMS radial presses (except for REMS Mini-Press) and suitable radial presses of other makes

System	Pressing tongs / pressing rings	Driven by adapter tongs	Art.-No.	
Jäger - Aquatec Edelstahl - Press Typ M	M 15		570110	
	M 18		570120	
	M 22		570130	
	M 28		570140	
	M 35		570150	
	M 42 (PR-3S)	Z2	572706	
	M 54 (PR-3S)	Z2	572708	
	M 76,1 XL (PR-3S)	Z6 XL ³⁾ / Z7 XL 45 kN ⁴⁾	579101	
	M 88,9 G XL (PR-3S)	Z6 XL ³⁾ / Z7 XL 45 kN ⁴⁾	579110	
	M 108,0 G XL (PR-3S)	Z6 XL ³⁾ / Z7 XL 45 kN ⁴⁾	579111	
	M 15 S (PR-2B)	Z8	574738	
	M 18 S (PR-2B)	Z8	574740	
	M 22 S (PR-2B)	Z8	574742	
	M 28 S (PR-2B)	Z8	574744	
	M 35 S (PR-2B)	Z8	574746	
Jäger - Aquatec Kupfer - Press Typ V	V 15		570115	
	V 18		570125	
	V 22		570135	
	V 28		570145	
	V 35		570155	
	V 42		570165	
	V 42 (PR-2B)	Z2	572850	
	V 54		570175	
	V 54 (PR-2B)	Z2	572851	
	V 15 S (PR-2B)	Z8	574752	
	V 18 S (PR-2B)	Z8	574756	
	V 22 S (PR-2B)	Z8	574758	
	V 28 S (PR-2B)	Z8	574760	
	V 35 S (PR-2B)	Z8	574762	
	Jansen AG JANSEN COMISA	TH 14*		570455
TH 16*			570460	
TH 20*			570470	
TH 26*			570475	
TH 32			570480	
TH 40			570485	
TH 50 (PZ-S)			572400	
TH 63 (PZ-S)			572405	
TH 16 S (PR-2B)		Z8	574782	
TH 20 S (PR-2B)		Z8	574788	
TH 26 S (PR-2B)		Z8	574794	
TH 32 S (PR-2B)		Z8	574798	
Jarafflex- Presssystem		TH 14*		570455
		TH 16*		570460
		TH 17*		570462
	TH 18*		570465	
	TH 20*		570470	
	TH 25*		570495	
	TH 26*		570475	
	TH 32		570480	
	TH 40		570485	
	TH 50 (PZ-S)		572400	
	TH 63 (PZ-S)		572405	
	TH 16 S (PR-2B)	Z8	574782	
	TH 20 S (PR-2B)	Z8	574788	
	TH 26 S (PR-2B)	Z8	574794	
	TH 32 S (PR-2B)	Z8	574798	
JUNGWOO JWPress	VUS ½" (OD 15,9 mm)		571770	
	VUS ¾" (OD 22,2 mm)		571775	
	VUS 1" (OD 28,6 mm)		571780	
	VUS 1 ¼" (OD 34,9 mm)		571785	
	VUS 1 ½" (OD 41,3 mm)		571790	
	VUS 2" (OD 54,0 mm)		571795	
	VUSFz 2 ½" (PR-3B) (OD 66,7 mm)	Z5	572819	
	VUSFz 3" (PR-3B) (OD 79,4 mm)	Z5	572820	
	VUSFz 4" (PR-3B) (OD 104,8 mm)	Z5	572821	
	K			
KAN KAN-therm Press	U 16*		570765	
	U 20*		570775	
	U 25*		570780	
	C 26*		570750	
	U 32		570785	
	U 40		570790	
	TH 50 (PZ-S)		572400	
TH 63 (PZ-S)		572405		

System	Pressing tongs / pressing rings	Driven by adapter tongs	Art.-No.
KAN KAN-therm Press LBP	U 14*		570760
	U 16*		570765
	U 20*		570775
	U 25*		570780
	C 26*		570750
	U 32		570785
	U 40		570790
	TH 14*		570455
	TH 16*		570460
	TH 20*		570470
	TH 25*		570495
	TH 26*		570475
	TH 32		570480
	TH 40		570485
	TH 50 (PZ-S)		572400
TH 63 (PZ-S)		572405	
TH 16 S (PR-2B)	Z8	574782	
TH 20 S (PR-2B)	Z8	574788	
TH 26 S (PR-2B)	Z8	574794	
TH 32 S (PR-2B)	Z8	574798	
KAN KAN-therm Inox	M 12		570100
	M 15		570110
	M 18 ¹⁾		570120
	M 22		570130
	M 28 ¹⁾		570140
	M 35		570150
	M 42 (PZ-4G)		570160
	M 54 (PZ-4G)		570170
	M 42 (PR-3S)	Z2	572706
	M 54 (PR-3S)	Z2	572708
	M 76,1 XL (PR-3S)	Z6 XL ³⁾ / Z7 XL 45 kN ⁴⁾	579101
	M 88,9 G XL (PR-3S)	Z6 XL ³⁾ / Z7 XL 45 kN ⁴⁾	579110
	M 108,0 G XL (PR-3S)	Z6 XL ³⁾ / Z7 XL 45 kN ⁴⁾	579111
	M 12 S (PR-2B)	Z8	574736
	M 15 S (PR-2B)	Z8	574738
M 18 S (PR-2B)	Z8	574740	
M 22 S (PR-2B)	Z8	574742	
M 28 S (PR-2B)	Z8	574744	
M 35 S (PR-2B)	Z8	574746	
KAN KAN-therm Steel	M 12		570100
	M 15		570110
	M 18 ¹⁾		570120
	M 22		570130
	M 28 ¹⁾		570140
	M 35		570150
	M 42 (PZ-4G)		570160
	M 54 (PZ-4G)		570170
	M 42 (PR-3S)	Z2	572706
	M 54 (PR-3S)	Z2	572708
	XP 66,7 XL (PR-3S)	Z6 XL ³⁾ / Z7 XL 45 kN ⁴⁾	579108
	M 76,1 XL (PR-3S)	Z6 XL ³⁾ / Z7 XL 45 kN ⁴⁾	579101
	M 88,9 G XL (PR-3S)	Z6 XL ³⁾ / Z7 XL 45 kN ⁴⁾	579110
	M 108,0 G XL (PR-3S)	Z6 XL ³⁾ / Z7 XL 45 kN ⁴⁾	579111
	M 12 S (PR-2B)	Z8	574736
M 15 S (PR-2B)	Z8	574738	
M 18 S (PR-2B)	Z8	574740	
M 22 S (PR-2B)	Z8	574742	
M 28 S (PR-2B)	Z8	574744	
M 35 S (PR-2B)	Z8	574746	
KAN KAN-therm UltraPRESS	U 14*		570760
	U 16*		570765
	U 20*		570775
	U 25*		570780
	C 26*		570750
	U 32		570785
	U 40		570790
	TH 14*		570455
	TH 16*		570460
	TH 20*		570470
	TH 25*		570495
	TH 26*		570475
	TH 32		570480
	TH 40		570485
	TH 50 (PZ-S)		572400
TH 63 (PZ-S)		572405	
TH 16 S (PR-2B)	Z8	574782	
TH 20 S (PR-2B)	Z8	574788	
TH 26 S (PR-2B)	Z8	574794	
TH 32 S (PR-2B)	Z8	574798	

Pressfitting systems for gas installations must only be pressed with pressing tongs/pressing rings which are highlighted in yellow.

Observe the national regulations. Read and observe the instructions for use and the installation instructions of the system provider/manufacturer.

* These pressing tongs also fit the manual radial press REMS Eco-Press. Observe the national regulations.

¹⁾ Only pressing tongs from designation "108" (1st quarter of 2008), "208" (2nd quarter of 2008) etc. can be used. The designation is stamped on every pressing jaw.

²⁾ For this pressfitting system producing a pressing joint with manual radial presses is not permitted.

³⁾ Driven by REMS Power-Press XL ACC.

⁴⁾ Driven by REMS Akku-Press XL 45 kN 22 V ACC.

⁵⁾ For taking suitable pressing inserts.

⁶⁾ Press fittings made of red bronze (Sanpress XL) must be pressed with pressing rings with press contour VR, copper fittings (Profipress XL, Profipress G XL), carbon steel (Prestabo XL) and stainless steel fittings (Sanpress Inox XL, Sanpress Inox G XL) with pressing rings with press contour VF.

⁷⁾ Use pressing rings labelled "M 88.9 G" or "M 108 G" on the three pressing segments for gas installations.

⁸⁾ For making press joints for operating pressure ≤ PN 10.

⁹⁾ For pipes of the EN technical standard. Observe the instructions for use of the system provider/manufacturer.

¹⁰⁾ For pipes of the ASTM technical standard. Observe the instructions for use of the system provider/manufacturer.

The suitability of REMS pressing tools for pressfitting systems: Date 12.10.2022. For the updated situation regarding suitability status check our website:

www.rems.de > Downloads > Product catalogues, brochures > REMS Catalogue.

See page 236 for adapter tongs. Pressing tongs/pressing rings for additional pressfitting systems on request.

REMS pressing tongs REMS pressing rings

Accessories for REMS radial presses (except for REMS Mini-Press)
and suitable radial presses of other makes

System	Pressing tongs / pressing rings	Driven by adapter tongs	Art.-No.	
KE KELIT COPPERFIX Kupfer	M 15		570110	
	M 18		570120	
	M 22		570130	
	M 28		570140	
	M 35		570150	
	M 42 (PR-3S)	Z2	572706	
	M 54 (PR-3S)	Z2	572708	
	M 76,1 XL (PR-3S)	Z6 XL ³⁾ / Z7 XL 45 kN ⁴⁾	579101	
	M 88,9 G XL (PR-3S)	Z6 XL ³⁾ / Z7 XL 45 kN ⁴⁾	579110	
	M 108,0 G XL (PR-3S)	Z6 XL ³⁾ / Z7 XL 45 kN ⁴⁾	579111	
	M 15 S (PR-2B)	Z8	574738	
	M 18 S (PR-2B)	Z8	574740	
	M 22 S (PR-2B)	Z8	574742	
	M 28 S (PR-2B)	Z8	574744	
	M 35 S (PR-2B)	Z8	574746	
	KE KELIT KELIT KELOX	U 16*		570765
		U 18*		570770
U 20*			570775	
U 25*			570780	
U 32			570785	
U 40			570790	
U 50			570795	
U 63 (PZ-S)			572365	
U 63 (PR-3B)		Z4	572837	
U 75 (PR-3B)		Z4	572828	
KE KELIT KELOX-PPSU-W	U 16*		570765	
	U 18*		570770	
	U 20*		570775	
	U 25*		570780	
	U 32		570785	
	U 40		570790	
	U 50		570795	
	U 63 (PZ-S)		572365	
	U 63 (PR-3B)	Z4	572837	
	U 75 (PR-3B)	Z4	572828	
KE KELIT KELOX-ULTRAX	U 16*		570765	
	U 18*		570770	
	U 20*		570775	
	U 25*		570780	
	U 32		570785	
	U 40		570790	
	U 50		570795	
	U 63 (PZ-S)		572365	
	U 63 (PR-3B)	Z4	572837	
	U 75 (PR-3B)	Z4	572828	
KE KELIT KELOX-ULTRAX-W	U 16*		570765	
	U 18*		570770	
	U 20*		570775	
	U 25*		570780	
	U 32		570785	
	U 40		570790	
	U 50		570795	
	U 63 (PZ-S)		572365	
	U 63 (PR-3B)	Z4	572837	
	U 75 (PR-3B)	Z4	572828	
KE KELIT KELOX-WINDOWX-U	U 16*		570765	
	U 18*		570770	
	U 20*		570775	
	U 25*		570780	
	U 32		570785	
	U 40		570790	
	U 50		570795	
	U 63 (PZ-S)		572365	
	U 63 (PR-3B)	Z4	572837	
	U 75 (PR-3B)	Z4	572828	
KE KELIT steelFIX C-Stahl	M 15		570110	
	M 18		570120	
	M 22		570130	
	M 28		570140	
	M 35		570150	
	M 42 (PR-3S)	Z2	572706	
	M 54 (PR-3S)	Z2	572708	
	M 76,1 XL (PR-3S)	Z6 XL ³⁾ / Z7 XL 45 kN ⁴⁾	579101	
	M 88,9 G XL (PR-3S)	Z6 XL ³⁾ / Z7 XL 45 kN ⁴⁾	579110	
	M 108,0 G XL (PR-3S)	Z6 XL ³⁾ / Z7 XL 45 kN ⁴⁾	579111	
	M 15 S (PR-2B)	Z8	574738	
	M 18 S (PR-2B)	Z8	574740	
	M 22 S (PR-2B)	Z8	574742	
	M 28 S (PR-2B)	Z8	574744	
	M 35 S (PR-2B)	Z8	574746	
	KE KELIT steelFIX Edelstahl	M 15		570110
		M 18		570120
M 22			570130	
M 28			570140	
M 35			570150	
M 42 (PR-3S)		Z2	572706	
M 54 (PR-3S)		Z2	572708	
M 76,1 XL (PR-3S)		Z6 XL ³⁾ / Z7 XL 45 kN ⁴⁾	579101	
M 88,9 G XL (PR-3S)		Z6 XL ³⁾ / Z7 XL 45 kN ⁴⁾	579110	
M 108,0 G XL (PR-3S)		Z6 XL ³⁾ / Z7 XL 45 kN ⁴⁾	579111	
M 15 S (PR-2B)		Z8	574738	
M 18 S (PR-2B)		Z8	574740	
M 22 S (PR-2B)		Z8	574742	
M 28 S (PR-2B)		Z8	574744	
M 35 S (PR-2B)		Z8	574746	
KEMBLA KemPress (AUS)		VAU 15 (OD 12,7 mm)		572687
		VAU 20 (OD 19,1 mm)		572689
	VAU 25 (OD 25,4 mm)		572691	
	VAU 32 (OD 31,8 mm)		572693	
	VAU 40 (OD 38,1 mm)		572695	
	VAU 50 (OD 50,8 mm)		572697	
KEMBLA KemPress Gas (AUS)	VAU 15 (OD 12,7 mm)		572687	
	VAU 20 (OD 19,1 mm)		572689	
	VAU 25 (OD 25,4 mm)		572691	
	VAU 32 (OD 31,8 mm)		572693	
	VAU 40 (OD 38,1 mm)		572695	
	VAU 50 (OD 50,8 mm)		572697	

System	Pressing tongs / pressing rings	Driven by adapter tongs	Art.-No.
KISAN Kisan KD	KI 16*		571360
	KI 20*		571370
	KI 25*		571375
	TH 16*		570460
	TH 20*		570470
KISAN Kisan WL	TH 25*		570495
	TH 16 S (PR-2B)	Z8	574782
	TH 20 S (PR-2B)	Z8	574788
	KI 16*		571360
	KI 20*		571370
KISAN Kisan WM	KI 25*		571375
	KI 32		571380
	TH 16*		570460
	TH 20*		570470
	TH 25*		570495
KISAN Kisan WR	TH 32		570480
	TH 16 S (PR-2B)	Z8	574782
	TH 20 S (PR-2B)	Z8	574788
	TH 32 S (PR-2B)	Z8	574798
	KI 16*		571360
KISAN Kisan WR	KI 20*		571370
	KI 25*		571375
	KI 32		571380
	U 20*		570775
	U 25*		570780
KISAN Kistal C	U 32		570785
	U 40		570790
	U 50		570795
	U 63 (PZ-S)		572365
	U 75 (PR-3B)	Z2	572706
	M 54 (PR-3S)	Z2	572708
	M 76,1 XL (PR-3S)	Z6 XL ³⁾ / Z7 XL 45 kN ⁴⁾	579101
	M 88,9 G XL (PR-3S)	Z6 XL ³⁾ / Z7 XL 45 kN ⁴⁾	579110
	M 108,0 G XL (PR-3S)	Z6 XL ³⁾ / Z7 XL 45 kN ⁴⁾	579111
	M 15 S (PR-2B)	Z8	574738
KISAN Kistal Inox	M 18 S (PR-2B)	Z8	574740
	M 22 S (PR-2B)	Z8	574742
	M 28 S (PR-2B)	Z8	574744
	M 35 S (PR-2B)	Z8	574746
	M 15		570110
	M 18		570120
	M 22		570130
	M 28		570140
	M 35		570150
	M 42 (PR-3S)	Z2	572706
LEGEND-PRESS press fitting system	M 54 (PR-3S)	Z2	572708
	M 76,1 XL (PR-3S)	Z6 XL ³⁾ / Z7 XL 45 kN ⁴⁾	579101
	M 88,9 G XL (PR-3S)	Z6 XL ³⁾ / Z7 XL 45 kN ⁴⁾	579110
	M 108,0 G XL (PR-3S)	Z6 XL ³⁾ / Z7 XL 45 kN ⁴⁾	579111
	M 15 S (PR-2B)	Z8	574738
	M 18 S (PR-2B)	Z8	574740
	M 22 S (PR-2B)	Z8	574742
	M 28 S (PR-2B)	Z8	574744
	M 35 S (PR-2B)	Z8	574746
	VUS ½" (OD 15,9 mm)		571770
VUS ¾" (OD 22,2 mm)		571775	
VUS 1" (OD 28,6 mm)		571780	
VUS 1¼" (OD 34,9 mm)		571785	
VUS 1½" (OD 41,3 mm)		571790	
VUS 2" (OD 54,0 mm)		571795	
VUSFz 2½" (PR-3B) (OD 66,7 mm)	Z5	572819	
VUSFz 3" (PR-3B) (OD 79,4 mm)	Z5	572820	
VUSFz 4" (PR-3B) (OD 104,8 mm)	Z5	572821	
LK Systems LK >B-Press	V 12		570107
	V 15		570115
	V 18		570125
	V 22		570135
	V 28		570145
	V 35		570155
	V 42		570165
	V 54		570175
	V 12 S (PR-2B)	Z8	574748
	V 15 S (PR-2B)	Z8	574752
LK Systems LK >B-Press Eltörzinkat	V 18 S (PR-2B)	Z8	574756
	V 22 S (PR-2B)	Z8	574758
	V 28 S (PR-2B)	Z8	574760
	V 35 S (PR-2B)	Z8	574762
	V 12		570107
	V 15		570115
	V 18		570125
	V 22		570135
	V 28		570145
	V 35		570155
LK Systems LK >B-Press Eltörzinkat	V 42		570165
	V 54		570175
	V 12 S (PR-2B)	Z8	574748
	V 15 S (PR-2B)	Z8	574752
	V 18 S (PR-2B)	Z8	574756
	V 22 S (PR-2B)	Z8	574758
V 28 S (PR-2B)	Z8	574760	
V 35 S (PR-2B)	Z8	574762	

REMS pressing tongs REMS pressing rings

Accessories for REMS radial presses (except for REMS Mini-Press) and suitable radial presses of other makes

System	Pressing tongs/ pressing rings	Driven by adapter tongs	Art.-No.
LK Systems	V 15		570115
LK >B-Press	V 18		570125
Gas	V 22		570135
	V 28		570145
	V 35		570155
	V 42		570165
	V 54		570175
	V 15 S (PR-2B)	Z8	574752
	V 18 S (PR-2B)	Z8	574756
	V 22 S (PR-2B)	Z8	574758
	V 28 S (PR-2B)	Z8	574760
	V 35 S (PR-2B)	Z8	574762
LK Systems	TH 16*		570460
LK Universal	TH 20*		570470
	TH 25*		570495
	TH 32		570480
	TH 40		570485
	TH 50 (PZ-S)		572400
	TH 63 (PZ-S)		572405
LVI-DAHL	U 16*		570765
Altech-Alupex	U 20*		570775
	U 25*		570780
	U 32		570785
M			
MAINCOR	U 16*		570765
MAINPRESS	U 20*		570775
	U 25*		570780
	U 32		570785
	U 40		570790
	U 50		570795
	U 63 (PZ-S)		572365
	U 63 (PR-3B)	Z4	572837
MAINCOR	U 16*		570765
MAINFLOR	U 20*		570775
Mair Heiztechnik	H 11,5*		570315
M-Press	TH 16*		570460
	TH 20*		570470
	TH 26*		570475
	TH 32		570480
	TH 40		570485
	TH 16 S (PR-2B)	Z8	574782
	TH 20 S (PR-2B)	Z8	574788
	TH 26 S (PR-2B)	Z8	574794
	TH 32 S (PR-2B)	Z8	574798
Ma.s.ter System	TH 14*		570455
PRESSMASTER	TH 16*		570460
	TH 18*		570465
	TH 20*		570470
	TH 25*		570495
	TH 26*		570475
	TH 32		570480
	TH 40		570485
	TH 50 (PZ-S)		572400
	TH 63 (PZ-S)		572405
	TH 16 S (PR-2B)	Z8	574782
	TH 20 S (PR-2B)	Z8	574788
	TH 26 S (PR-2B)	Z8	574794
	TH 32 S (PR-2B)	Z8	574798
	H 14*		570310
	H 16*		570320
	H 18*		570340
	H 20*		570350
	H 26*		570370
	H 32		570380
	H 40 (PZ-4G)		570390
	U 14*		570760
	U 16*		570765
	U 18*		570770
	U 20*		570775
	U 25*		570780
	U 32		570785
	U 40		570790
	U 50		570795
	U 63 (PR-3B)	Z4	572837
	U 63 (PZ-S)		572365

System	Pressing tongs/ pressing rings	Driven by adapter tongs	Art.-No.
Meier Tobler	H 16*		570320
Metalplast - Stramax	H 20*		570350
Serie MM	H 25*		570360
	H 32		570380
	RFz 16*		571325
	RFz 20*		571330
	RFz 25		571335
	RFz 32		571340
	TH 16*		570460
	TH 20*		570470
	TH 25*		570495
	TH 32		570480
	TH 40		570485
	TH 50 (PZ-S)		572400
	TH 63 (PZ-S)		572405
	TH 16 S (PR-2B)	Z8	574782
	TH 20 S (PR-2B)	Z8	574788
	TH 32 S (PR-2B)	Z8	574798
	U 16*		570765
	U 20*		570775
	U 25*		570780
	U 32		570785
	U 40		570790
	U 50		570795
	U 63 (PZ-S)		572365
	U 63 (PR-3B)	Z4	572837
METALGRUP	U 16*		570765
Permatubo	U 18*		570770
	U 20*		570775
	U 25*		570780
	U 32		570785
	U 40		570790
	U 50		570795
	U 63 (PR-3B)	Z4	572837
	U 63 (PZ-S)		572365
METALGRUP	RFz 16*		571325
PexGrup	RFz 20*		571330
	RFz 25		571335
	RFz 32		571340
METALGRUP	U 16*		570765
MultiGrup	U 18*		570770
	U 20*		570775
	U 25*		570780
	U 32		570785
Mueller Industries	VUS ½" (OD 15,9 mm)		571770
Streamline PRS	VUS ¾" (OD 22,2 mm)		571775
	VUS 1" (OD 28,6 mm)		571780
	VUS 1¼" (OD 34,9 mm)		571785
	VUS 1½" (OD 41,3 mm)		571790
	VUS 2" (OD 54,0 mm)		571795
	VUSFz 2½" (PR-3B) (OD 66,7 mm)	Z5	572819
	VUSFz 3" (PR-3B) (OD 79,4 mm)	Z5	572820
	VUSFz 4" (PR-3B) (OD 104,8 mm)	Z5	572821
MULTITHERM	TH 16*		570460
PRESSSYSTEM	TH 20*		570470
	TH 26*		570475
	TH 32		570480
	TH 40		570485
	TH 50 (PZ-S)		572400
	TH 63 (PZ-S)		572405
	THz 75 (PR-3B)	Z4	572829
	TH 16 S (PR-2B)	Z8	574782
	TH 20 S (PR-2B)	Z8	574788
	TH 26 S (PR-2B)	Z8	574794
	TH 32 S (PR-2B)	Z8	574798
Multicapas Industrial	RFz 16*		571325
AIS PEX	RFz 20*		571330
	RFz 25		571335
	RFz 32		571340
	U 16*		570765
	U 20*		570775
	U 25*		570780
	U 32		570785

Pressfitting systems for gas installations must only be pressed with pressing tongs/pressing rings which are highlighted in yellow.

Observe the national regulations. Read and observe the instructions for use and the installation instructions of the system provider/manufacturer.

* These pressing tongs also fit the manual radial press REMS Eco-Press. Observe the national regulations.

- 1) Only pressing tongs from designation "108" (1st quarter of 2008), "208" (2nd quarter of 2008) etc. can be used. The designation is stamped on every pressing jaw.
- 2) For this pressfitting system producing a pressing joint with manual radial presses is not permitted.
- 3) Driven by REMS Power-Press XL ACC.
- 4) Driven by REMS Akku-Press XL 45 kN 22 V ACC.
- 5) For taking suitable pressing inserts.
- 6) Press fittings made of red bronze (Sanpress XL) must be pressed with pressing rings with press contour VR, copper fittings (Profipress XL, Profipress G XL), carbon steel (Prestabo XL) and stainless steel fittings (Sanpress Inox XL, Sanpress Inox G XL) with pressing rings with press contour VF.
- 7) Use pressing rings labelled "M 88.9 G" or "M 108 G" on the three pressing segments for gas installations.
- 8) For making press joints for operating pressure ≤ PN 10.
- 9) For pipes of the EN technical standard. Observe the instructions for use of the system provider/manufacturer.
- 10) For pipes of the ASTM technical standard. Observe the instructions for use of the system provider/manufacturer.

The suitability of REMS pressing tools for pressfitting systems: Date 12.10.2022. For the updated situation regarding suitability status check our website: www.rems.de > Downloads > Product catalogues, brochures > REMS Catalogue.

See page 236 for adapter tongs. Pressing tongs/pressing rings for additional pressfitting systems on request.

REMS pressing tongs

REMS pressing rings

Accessories for REMS radial presses (except for REMS Mini-Press) and suitable radial presses of other makes

System	Pressing tongs / pressing rings	Driven by adapter tongs	Art.-No.	
Multicap Industrial AIS XPRT	H 16*		570320	
	H 20*		570350	
	H 25*		570360	
	H 26*		570370	
	H 32		570380	
	RFz 16*		571325	
	RFz 20*		571330	
	RFz 25		571335	
	RFz 32		571340	
	TH 16*		570460	
	TH 20*		570470	
	TH 25*		570495	
	TH 26*		570475	
	TH 32		570480	
	TH 40		570485	
	TH 50 (PZ-S)		572400	
	TH 63 (PZ-S)		572405	
	THz 75 (PR-3B)	Z4	572829	
	TH 16 S (PR-2B)	Z8	574782	
	TH 20 S (PR-2B)	Z8	574788	
	TH 26 S (PR-2B)	Z8	574794	
	TH 32 S (PR-2B)	Z8	574798	
	U 16*		570765	
	U 20*		570775	
	U 25*		570780	
	U 32		570785	
	U 40		570790	
	U 50		570795	
	U 63 (PZ-S)		572365	
	U 63 (PR-3B)	Z4	572837	
	U 75 (PR-3B)	Z4	572828	
	Multicap Industrial multitubo systems MC	U 16*		570765
		U 18*		570770
U 20*			570775	
U 25*			570780	
U 32			570785	
U 40			570790	
U 50			570795	
U 63 (PZ-S)			572365	
U 63 (PR-3B)		Z4	572837	
U 75 (PR-3B)		Z4	572828	
Multicap Industrial multitubo systems MM	H 16*		570320	
	H 20*		570350	
	H 25*		570360	
	H 26*		570370	
	H 32		570380	
	RFz 16*		571325	
	RFz 20*		571330	
	RFz 25		571335	
	RFz 32		571340	
	TH 16*		570460	
	TH 20*		570470	
	TH 25*		570495	
	TH 26*		570475	
	TH 32		570480	
	TH 40		570485	
	TH 50 (PZ-S)		572400	
	TH 63 (PZ-S)		572405	
	THz 75 (PR-3B)	Z4	572829	
	TH 16 S (PR-2B)	Z8	574782	
	TH 20 S (PR-2B)	Z8	574788	
	TH 26 S (PR-2B)	Z8	574794	
	TH 32 S (PR-2B)	Z8	574798	
	U 16*		570765	
	U 20*		570775	
	U 25*		570780	
	U 32		570785	
	U 40		570790	
	U 50		570795	
	U 63 (PZ-S)		572365	
	U 63 (PR-3B)	Z4	572837	
	U 75 (PR-3B)	Z4	572828	
	N			
	NEUTHERM MEKUPRESS-HT	H 16*		570320
H 20*			570350	
H 26*			570370	
H 32			570380	
H 40 (PZ-4G)			570390	
U 40			570790	
NIBCO (USA) Press System Copper	VUS 1/2" (OD 15,9 mm)		571770	
	VUS 3/4" (OD 22,2 mm)		571775	
	VUS 1" (OD 28,6 mm)		571780	
	VUS 1 1/4" (OD 34,9 mm)		571785	
	VUS 1 1/2" (OD 41,3 mm)		571790	
VUS 2" (OD 54,0 mm)		571795		
NICOLL FLUXO	TH 16*		570460	
	TH 20*		570470	
	TH 26*		570475	
	TH 32		570480	
	TH 40		570485	
	TH 50 (PZ-S)		572400	
	TH 63 (PZ-S)		572405	
	THz 75 (PR-3B)	Z4	572829	
	TH 16 S (PR-2B)	Z8	574782	
	TH 20 S (PR-2B)	Z8	574788	
	TH 26 S (PR-2B)	Z8	574794	
	TH 32 S (PR-2B)	Z8	574798	

System	Pressing tongs / pressing rings	Driven by adapter tongs	Art.-No.
NUPI Industrie Italiana Multinupi	B 16*		570850
	B 18*		570855
	B 20*		570860
	B 26		570870
	B 32		570880
	F 16*		570717
	F 18*		570720
	F 20*		570727
	F 26*		570730
	F 32		570735
	F 16 S (PR-2B)	Z8	574728
	F 20 S (PR-2B)	Z8	574730
	F 26 S (PR-2B)	Z8	574732
	F 32 S (PR-2B)	Z8	574734
	H 16*		570320
	H 18*		570340
	H 20*		570350
	H 25*		570360
	H 26*		570370
	H 32		570380
	TH 16*		570460
	TH 18*		570465
	TH 20*		570470
	TH 25*		570495
	TH 26*		570475
	TH 32		570480
	TH 16 S (PR-2B)	Z8	574782
	TH 20 S (PR-2B)	Z8	574788
	TH 26 S (PR-2B)	Z8	574794
	TH 32 S (PR-2B)	Z8	574798
	U 14*		570760
	U 16*		570765
	U 18*		570770
U 20*		570775	
U 25*		570780	
C 26*		570750	
U 32		570785	
U 40		570790	
U 50		570795	
U 63 (PR-3B)	Z4	572837	
U 63 (PZ-S)		572365	
Nussbaum Optifitt-Press	VMP 3/8" (OD 17,2 mm)		571740
	VMP 1/2" (OD 21,3 mm)		571762
	VMPz 3/4" (OD 26,9 mm)		571764
	VMPz 1" (OD 33,7 mm)		571767
	VMPz 1 1/4" (PZ-S) (OD 42,4 mm)		572413
VMPz 1 1/2" (PR-3B) (OD 48,3 mm)	Z5	572844	
VMPz 2" (PR-3B) (OD 60,3 mm)	Z5	572845	
Nussbaum Optiflex-Flowpress	VRX 16		571750
	VRX 20		571752
	VRX 25		571754
	VRX 32		571756
	VRX 40		571758
	VRX 50		571760
VRX 63		571797	
Nussbaum Optipress Aquaplus	V 15		570115
	V 18		570125
	V 22		570135
	V 28		570145
	V 35		570155
	V 42		570165
	V 42 (PR-2B)	Z2	572850
	V 54		570175
	V 54 (PR-2B)	Z2	572851
	Vfz 64,0 (PR-3B)	Z5	572815
	Vfz 76,1 (PR-3B)	Z5	572816
	Vfz 88,9 (PR-3B)	Z5	572817
	Vfz 108,0 (PR-3B)	Z5	572818
	V 15 S (PR-2B)	Z8	574752
	V 18 S (PR-2B)	Z8	574756
V 22 S (PR-2B)	Z8	574758	
V 28 S (PR-2B)	Z8	574760	
V 35 S (PR-2B)	Z8	574762	
Nussbaum Optipress-Gaz	V 15		570115
	V 18		570125
	V 22		570135
	V 28		570145
	V 35		570155
	V 42		570165
	V 42 (PR-2B)	Z2	572850
	V 54		570175
	V 54 (PR-2B)	Z2	572851
	Vfz 64,0 (PR-3B)	Z5	572815
Nussbaum Optipress-Therm	V 15		570115
	V 18		570125
	V 22		570135
	V 28		570145
	V 35		570155
	V 42		570165
	V 42 (PR-2B)	Z2	572850
	V 54		570175
	V 54 (PR-2B)	Z2	572851
	Vfz 64,0 (PR-3B)	Z5	572815

REMS pressing tongs REMS pressing rings

Accessories for REMS radial presses (except for REMS Mini-Press) and suitable radial presses of other makes

System	Pressing tongs / pressing rings	Driven by adapter tongs	Art.-No.
O			
Oventrop Cofit P	H 16 A*		570620
	H 20 A*		570650
	H 26 A*		570670
	H 32 A		570680
	H 40 A		570690
	U 50		570795
	U 63 (PR-3B)	Z4	572837
	U 63 (PZ-S)		572365
Oventrop Cofit PD	H 16 A*		570620
	H 20 A*		570650
	H 26 A*		570670
Oventrop Cofit PDK	H 16 A*		570620
	H 20 A*		570650
Oventrop Cofit PD-HT	H 16 A*		570620
	H 20 A*		570650
	H 25 A*		570660
	H 32 A		570680
Oventrop Cofit PDK-HT	H 16 A*		570620
	H 20 A*		570650
P			
PBTab SERTIPRESS	RFz 12*		571320
	RFz 16*		571325
	RFz 20*		571330
	RFz 25		571335
PBTab SERTI-STEEL	M 15		570110
	M 18		570120
	M 22		570130
	M 28		570140
	M 35		570150
	M 42 (PR-3S)	Z2	572706
	M 54 (PR-3S)	Z2	572708
	M 15 S (PR-2B)	Z8	574738
	M 18 S (PR-2B)	Z8	574740
	M 22 S (PR-2B)	Z8	574742
	M 28 S (PR-2B)	Z8	574744
	M 35 S (PR-2B)	Z8	574746
	Pegler Yorkshire XPress Carbon	M 12	
M 15			570110
M 18 ¹⁾			570120
M 22			570130
M 28 ¹⁾			570140
M 35			570150
M 42 (PR-3S)		Z2	572706
M 54 (PR-3S)		Z2	572708
XP 66,7 XL (PR-3S)		Z6 XL ³⁾ / Z7 XL 45 kN ⁴⁾	579108
M 76,1 XL (PR-3S)		Z6 XL ³⁾ / Z7 XL 45 kN ⁴⁾	579101
M 12 S (PR-2B)		Z8	574736
M 15 S (PR-2B)		Z8	574738
M 18 S (PR-2B)		Z8	574740
M 22 S (PR-2B)		Z8	574742
M 28 S (PR-2B)		Z8	574744
M 35 S (PR-2B)		Z8	574746
Pegler Yorkshire XPress Copper		M 12	
	M 15		570110
	M 18 ¹⁾		570120
	M 22		570130
	M 28 ¹⁾		570140
	M 35		570150
	M 42 (PR-3S)	Z2	572706
	M 54 (PR-3S)	Z2	572708
	XP 64,0 XL (PR-3S)	Z6 XL ³⁾ / Z7 XL 45 kN ⁴⁾	579100
	XP 66,7 XL (PR-3S)	Z6 XL ³⁾ / Z7 XL 45 kN ⁴⁾	579108
	M 76,1 XL (PR-3S)	Z6 XL ³⁾ / Z7 XL 45 kN ⁴⁾	579101
	M 88,9 G XL (PR-3S)	Z6 XL ³⁾ / Z7 XL 45 kN ⁴⁾	579110
	XP 108,0 XL (PR-3S)	Z6 XL ³⁾ / Z7 XL 45 kN ⁴⁾	579109
	M 12 S (PR-2B)	Z8	574736
	M 15 S (PR-2B)	Z8	574738
	M 18 S (PR-2B)	Z8	574740
	M 22 S (PR-2B)	Z8	574742
	M 28 S (PR-2B)	Z8	574744
	M 35 S (PR-2B)	Z8	574746

System	Pressing tongs / pressing rings	Driven by adapter tongs	Art.-No.	
Pegler Yorkshire XPress Copper Gas	M 15		570110	
	M 18 ¹⁾		570120	
	M 22		570130	
	M 28 ¹⁾		570140	
	M 35		570150	
	M 42 (PR-3S)	Z2	572706	
	M 54 (PR-3S)	Z2	572708	
Pegler Yorkshire XPress Stainless	M 15		570110	
	M 18 ¹⁾		570120	
	M 22		570130	
	M 28 ¹⁾		570140	
	M 35		570150	
	M 42 (PR-3S)	Z2	572706	
		M 54 (PR-3S)	Z2	572708
		M 76,1 XL (PR-3S)	Z6 XL ³⁾ / Z7 XL 45 kN ⁴⁾	579101
		M 88,9 G XL (PR-3S)	Z6 XL ³⁾ / Z7 XL 45 kN ⁴⁾	579110
		M 108,0 G XL (PR-3S)	Z6 XL ³⁾ / Z7 XL 45 kN ⁴⁾	579111
PERFEXIM PERFEKT SYSTEM	U 16*		570765	
	U 20*		570775	
	U 25*		570780	
	U 32		570785	
	PERFILTUBO PERFILALUPEX	U 16*		570765
		U 18*		570770
		U 20*		570775
		U 25*		570780
		U 32		570785
		U 40		570790
	U 50		570795	
	U 63 (PR-3B)	Z4	572837	
	U 63 (PZ-S)		572365	
	U 75 (PR-3B)	Z4	572828	
PERFILTUBO PERFILPRESS	M 15		570110	
	M 18		570120	
	M 22		570130	
	M 28		570140	
	M 35		570150	
	M 42 (PR-3S)	Z2	572706	
	M 54 (PR-3S)	Z2	572708	
	M 76,1 XL (PR-3S)	Z6 XL ³⁾ / Z7 XL 45 kN ⁴⁾	579101	
	M 15 S (PR-2B)	Z8	574738	
	M 18 S (PR-2B)	Z8	574740	
PEXTUBE PexTube	RFz 16*		571325	
	RFz 20*		571330	
	RFz 25		571337	
	RFz 32		571342	
	Pipelife C-PRESS	M 15		570110
		M 18		570120
		M 22		570130
		M 28		570140
		M 35		570150
		M 42 (PR-3S)	Z2	572706
M 54 (PR-3S)		Z2	572708	
M 76,1 XL (PR-3S)		Z6 XL ³⁾ / Z7 XL 45 kN ⁴⁾	579101	
M 88,9 G XL (PR-3S)		Z6 XL ³⁾ / Z7 XL 45 kN ⁴⁾	579110	
M 108,0 G XL (PR-3S)		Z6 XL ³⁾ / Z7 XL 45 kN ⁴⁾	579111	
M 15 S (PR-2B)		Z8	574738	
M 18 S (PR-2B)		Z8	574740	
M 22 S (PR-2B)	Z8	574742		
M 28 S (PR-2B)	Z8	574744		
M 35 S (PR-2B)	Z8	574746		

Pressfitting systems for gas installations must only be pressed with pressing tongs/pressing rings which are highlighted in yellow.

Observe the national regulations. Read and observe the instructions for use and the installation instructions of the system provider/manufacturer.

* These pressing tongs also fit the manual radial press REMS Eco-Press. Observe the national regulations.

¹⁾ Only pressing tongs from designation "108" (1st quarter of 2008), "208" (2nd quarter of 2008) etc. can be used. The designation is stamped on every pressing jaw.

²⁾ For this pressfitting system producing a pressing joint with manual radial presses is not permitted.

³⁾ Driven by REMS Power-Press XL ACC.

⁴⁾ Driven by REMS Akku-Press XL 45 kN 22 V ACC.

⁵⁾ For taking suitable pressing inserts.

⁶⁾ Press fittings made of red bronze (Sanpress XL) must be pressed with pressing rings with press contour VR, copper fittings (Profipress XL, Profipress G XL), carbon steel (Prestabo XL) and stainless steel fittings (Sanpress Inox XL, Sanpress Inox G XL) with pressing rings with press contour VF.

⁷⁾ Use pressing rings labelled "M 88.9 G" or "M 108 G" on the three pressing segments for gas installations.

⁸⁾ For making press joints for operating pressure ≤ PN 10.

⁹⁾ For pipes of the EN technical standard. Observe the instructions for use of the system provider/manufacturer.

¹⁰⁾ For pipes of the ASTM technical standard. Observe the instructions for use of the system provider/manufacturer.

The suitability of REMS pressing tools for pressfitting systems: Date 12.10.2022. For the updated situation regarding suitability status check our website:

www.rems.de > Downloads > Product catalogues, brochures > REMS Catalogue.

See page 236 for adapter tongs. Pressing tongs/pressing rings for additional pressfitting systems on request.

REMS pressing tongs

REMS pressing rings

Accessories for REMS radial presses (except for REMS Mini-Press) and suitable radial presses of other makes

System	Pressing tongs / pressing rings	Driven by adapter tongs	Art.-No.	
Pipelife RADOPRESS	TH 16*		570460	
	TH 18*		570465	
	TH 20*		570470	
	TH 26*		570475	
	TH 32		570480	
	TH 40		570485	
	TH 50 (PZ-S)		572400	
	TH 63 (PZ-S)		572405	
	TH 16 S (PR-2B)	Z8	574782	
	TH 20 S (PR-2B)	Z8	574788	
	TH 26 S (PR-2B)	Z8	574794	
	TH 32 S (PR-2B)	Z8	574798	
	Pipetec Connect	TH 16*		570460
		TH 20*		570470
TH 26*			570475	
TH 32			570480	
TH 40			570485	
TH 50 (PZ-S)			572400	
TH 63 (PZ-S)			572405	
TH 16 S (PR-2B)		Z8	574782	
TH 20 S (PR-2B)		Z8	574788	
TH 26 S (PR-2B)		Z8	574794	
TH 32 S (PR-2B)		Z8	574798	
U 16*			570765	
U 20*			570775	
U 25*			570780	
U 32		570785		
PLASTICA ALFA Multypex	TH 16*		570460	
	TH 20*		570470	
	TH 26*		570475	
	TH 32		570480	
	TH 16 S (PR-2B)	Z8	574782	
	TH 20 S (PR-2B)	Z8	574788	
	TH 26 S (PR-2B)	Z8	574794	
TH 32 S (PR-2B)	Z8	574798		
PLASTICA ALFA Multypex Air	TH 16*		570460	
	TH 20*		570470	
	TH 26*		570475	
	TH 32		570480	
	TH 16 S (PR-2B)	Z8	574782	
	TH 20 S (PR-2B)	Z8	574788	
	TH 26 S (PR-2B)	Z8	574794	
TH 32 S (PR-2B)	Z8	574798		
PLASTICA ALFA Multypexalfa Gas	TH 16*		570460	
	TH 20*		570470	
	TH 26*		570475	
	TH 16 S (PR-2B)	Z8	574782	
	TH 20 S (PR-2B)	Z8	574788	
	TH 26 S (PR-2B)	Z8	574794	
	TH 32 S (PR-2B)	Z8	574798	
PLASTICA ALFA Multypexalfa Gas protek	TH 16*		570460	
	TH 20*		570470	
	TH 26*		570475	
	TH 16 S (PR-2B)	Z8	574782	
	TH 20 S (PR-2B)	Z8	574788	
	TH 26 S (PR-2B)	Z8	574794	
	TH 32 S (PR-2B)	Z8	574798	
PLASTICA ALFA Multypex Plus	TH 16*		570460	
	TH 20*		570470	
	TH 26*		570475	
	TH 32		570480	
	TH 16 S (PR-2B)	Z8	574782	
	TH 20 S (PR-2B)	Z8	574788	
	TH 26 S (PR-2B)	Z8	574794	
TH 32 S (PR-2B)	Z8	574798		
PLASTICA ALFA Multypex Thermo	TH 16*		570460	
	TH 20*		570470	
	TH 26*		570475	
	TH 32		570480	
	TH 16 S (PR-2B)	Z8	574782	
	TH 20 S (PR-2B)	Z8	574788	
	TH 26 S (PR-2B)	Z8	574794	
TH 32 S (PR-2B)	Z8	574798		
PLASTICA ALFA Multypex Thermo Plus	TH 16*		570460	
	TH 20*		570470	
	TH 26*		570475	
	TH 32		570480	
	TH 16 S (PR-2B)	Z8	574782	
	TH 20 S (PR-2B)	Z8	574788	
	TH 26 S (PR-2B)	Z8	574794	
TH 32 S (PR-2B)	Z8	574798		
PLÁSTICOS FERRO	U 16*		570765	
	U 20*		570775	
	U 25*		570780	
	U 32		570785	
FERROPLAST GPF MULT Pressfitting MULTICAPA	U 16*		570765	
	U 20*		570775	
	U 25*		570780	
	U 32		570785	
PLÁSTICOS FERRO FERROPLAST GPF PPSU Pressfitting PEX y MULTICAPA	U 16*		570765	
	U 20*		570775	
	U 25*		570780	
	U 32		570785	
PLÁSTICOS FERRO FERROPLAST GPF PRESS Pressfitting PEX	Rfz 16*		571325	
	Rfz 20*		571330	
	Rfz 25		571335	
	Rfz 32		571340	
PLUMBING PLUS EZIPEX Crimp (AUS)	K16/P18*		572600	
	K/20*		572605	
	K/25*		572610	
	K32		572615	
	K1/40		572620	
	K1/50		572625	

System	Pressing tongs / pressing rings	Driven by adapter tongs	Art.-No.	
PLUMBING PLUS EZIPEX Gas (AUS)	K16/P18*		572600	
	K/20*		572605	
	K/25*		572610	
	K32		572615	
	K1/40		572620	
	K1/50		572625	
	PLUMBING PLUS EZIPEX Gas (AUS)	VAU 15 (OD 12,7 mm)		572687
		VAU 20 (OD 19,1 mm)		572689
		VAU 25 (OD 25,4 mm)		572691
		VAU 32 (OD 31,8 mm)		572693
VAU 40 (OD 38,1 mm)			572695	
VAU 50 (OD 50,8 mm)			572697	
VAUFz 65 (PR-3B) (OD 63,5 mm)		Z5	572839	
VAUFz 80 (PR-3B) (OD 76,2 mm)		Z5	572840	
PLUMBING PLUS EZIPEX Solar (AUS)	VAUFz 100 (PR-3B) (OD 101,6 mm)	Z5	572841	
	VAU 15 S (PR-2B) (OD 12,7 mm)	Z8	574804	
	VAU 20 S (PR-2B) (OD 19,1 mm)	Z8	574806	
	VAU 25 S (PR-2B) (OD 25,4 mm)	Z8	574808	
	VAU 15 (OD 12,7 mm)		572687	
	VAU 20 (OD 19,1 mm)		572689	
	VAU 25 (OD 25,4 mm)		572691	
	VAU 15 S (PR-2B) (OD 12,7 mm)	Z8	574804	
PLUMBING PLUS EZIPEX Water (AUS)	VAU 20 S (PR-2B) (OD 19,1 mm)	Z8	574806	
	VAU 25 S (PR-2B) (OD 25,4 mm)	Z8	574808	
	VAU 15 (OD 12,7 mm)		572687	
	VAU 20 (OD 19,1 mm)		572689	
	VAU 25 (OD 25,4 mm)		572691	
	VAU 32 (OD 31,8 mm)		572693	
	VAU 40 (OD 38,1 mm)		572695	
	VAU 50 (OD 50,8 mm)		572697	
POLYPIPE POLYSURE	VAUFz 65 (PR-3B) (OD 63,5 mm)	Z5	572839	
	VAUFz 80 (PR-3B) (OD 76,2 mm)	Z5	572840	
	VAUFz 100 (PR-3B) (OD 101,6 mm)	Z5	572841	
	VAU 15 S (PR-2B) (OD 12,7 mm)	Z8	574804	
	VAU 20 S (PR-2B) (OD 19,1 mm)	Z8	574806	
	VAU 25 S (PR-2B) (OD 25,4 mm)	Z8	574808	
	TH 10*		570467	
	TH 15*		570457	
POLYSAN Handelsges. m.b.H. & Co KG (Krems/Öster- reich)	TH 22*		570472	
	TH 28		570477	
	M 15		570110	
	M 18		570120	
	M 22		570130	
	M 28		570140	
	M 35		570150	
	M 42 (PR-3S)	Z2	572706	
	M 54 (PR-3S)	Z2	572708	
	M 76,1 XL (PR-3S)	Z6 XL ³⁾ / Z7 XL 45 kN ⁴⁾	579101	
POLYSAN Handelsges. m.b.H. & Co KG (Krems/Öster- reich)	M 88,9 G XL (PR-3S)	Z6 XL ³⁾ / Z7 XL 45 kN ⁴⁾	579110	
	M 108,0 G XL (PR-3S)	Z6 XL ³⁾ / Z7 XL 45 kN ⁴⁾	579111	
	M 15 S (PR-2B)	Z8	574738	
	M 18 S (PR-2B)	Z8	574740	
	M 22 S (PR-2B)	Z8	574742	
	M 28 S (PR-2B)	Z8	574744	
	M 35 S (PR-2B)	Z8	574746	
	M 15		570110	
	M 18		570120	
	M 22		570130	
POLYSAN- Edelstahl Press-System 1.4520	M 28		570140	
	M 35		570150	
	M 42 (PR-3S)	Z2	572706	
	M 54 (PR-3S)	Z2	572708	
	M 76,1 XL (PR-3S)	Z6 XL ³⁾ / Z7 XL 45 kN ⁴⁾	579101	
	M 88,9 G XL (PR-3S)	Z6 XL ³⁾ / Z7 XL 45 kN ⁴⁾	579110	
	M 108,0 G XL (PR-3S)	Z6 XL ³⁾ / Z7 XL 45 kN ⁴⁾	579111	
	M 15 S (PR-2B)	Z8	574738	
	M 18 S (PR-2B)	Z8	574740	
	M 22 S (PR-2B)	Z8	574742	
POLYSAN Handelsges. m.b.H. & Co KG (Krems/Öster- reich)	M 28 S (PR-2B)	Z8	574744	
	M 35 S (PR-2B)	Z8	574746	
	M 15		570110	
	M 18		570120	
	M 22		570130	
	M 28		570140	
	M 35		570150	
	M 42 (PR-3S)	Z2	572706	
	M 54 (PR-3S)	Z2	572708	
	M 76,1 XL (PR-3S)	Z7 XL 45 kN ⁴⁾	579101	
POLYSAN- Edelstahl Press-System Gas	M 88,9 G XL (PR-3S) ¹⁾	Z7 XL 45 kN ⁴⁾	579110	
	M 108,0 G XL (PR-3S) ²⁾	Z7 XL 45 kN ⁴⁾	579111	
	M 15 S (PR-2B)	Z8	574738	
	M 18 S (PR-2B)	Z8	574740	
	M 22 S (PR-2B)	Z8	574742	
	M 28 S (PR-2B)	Z8	574744	
	M 35 S (PR-2B)	Z8	574746	
	M 15		570110	
	M 18		570120	
	M 22		570130	
POLYSAN Handelsges. m.b.H. & Co KG (Krems/Öster- reich)	M 28		570140	
	M 35		570150	
	M 42 (PR-3S)	Z2	572706	
	M 54 (PR-3S)	Z2	572708	
	M 76,1 XL (PR-3S)	Z6 XL ³⁾ / Z7 XL 45 kN ⁴⁾	579101	
	M 88,9 G XL (PR-3S)	Z6 XL ³⁾ / Z7 XL 45 kN ⁴⁾	579110	
	M 108,0 G XL (PR-3S)	Z6 XL ³⁾ / Z7 XL 45 kN ⁴⁾	579111	
	M 15 S (PR-2B)	Z8	574738	
	M 18 S (PR-2B)	Z8	574740	
	M 22 S (PR-2B)	Z8	574742	
POLYSAN Handelsges. m.b.H. & Co KG (Krems/Öster- reich)	M 28 S (PR-2B)	Z8	574744	
	M 35 S (PR-2B)	Z8	574746	
	M 15		570110	
	M 18		570120	
	M 22		570130	
	M 28		570140	
	M 35		570150	
	M 42 (PR-3S)	Z2	572706	
	M 54 (PR-3S)	Z2	572708	
	M 76,1 XL (PR-3S)	Z6 XL ³⁾ / Z7 XL 45 kN ⁴⁾	579101	
POLYSAN- Edelstahl Press-System Wasser	M 88,9 G XL (PR-3S)	Z6 XL ³⁾ / Z7 XL 45 kN ⁴⁾	579110	
	M 108,0 G XL (PR-3S)	Z6 XL ³⁾ / Z7 XL 45 kN ⁴⁾	579111	
	M 15 S (PR-2B)	Z8	574738	
	M 18 S (PR-2B)	Z8	574740	
	M 22 S (PR-2B)	Z8	574742	
	M 28 S (PR-2B)	Z8	574744	
	M 35 S (PR-2B)	Z8	574746	
	M 15		570110	
	M 18		570120	
	M 22		570130	

REMS pressing tongs REMS pressing rings

Accessories for REMS radial presses (except for REMS Mini-Press) and suitable radial presses of other makes

System	Pressing tongs/ pressing rings	Driven by adapter tongs	Art.-No.		
POLYSAN Handelsges. m.b.H. & Co KG (Krems/Öster- reich)	TH 14*		570455		
	TH 16*		570460		
	TH 17*		570462		
	TH 18*		570465		
	TH 20*		570470		
	POLYSAN- Press-System	TH 26*		570475	
		TH 32		570480	
		TH 40		570485	
		TH 50 (PZ-S)		572400	
		TH 63 (PZ-S)		572405	
		THz 75 (PR-3B)	Z4	572829	
		TH 16 S (PR-2B)	Z8	574782	
		TH 20 S (PR-2B)	Z8	574788	
		TH 26 S (PR-2B)	Z8	574794	
		TH 32 S (PR-2B)	Z8	574798	
POLYSAN Handelsges. m.b.H. & Co KG (Krems/Öster- reich)	TH 14*		570455		
	TH 16*		570460		
	TH 17*		570462		
	TH 18*		570465		
	TH 20*		570470		
	POLYSAN-Henco- Press-System	TH 26*		570475	
		HE 32		571900	
		HEz 40		571904	
		TH 16 S (PR-2B)	Z8	574782	
		TH 20 S (PR-2B)	Z8	574788	
		TH 26 S (PR-2B)	Z8	574794	
		POLYSAN (España) „Rainbow“	U 16*		570765
			U 18*		570770
			U 20*		570775
			U 25*		570780
U 32			570785		
U 40			570790		
U 50			570795		
U 63 (PR-3B)	Z4		572837		
U 63 (PZ-S)			572365		
Prandelli Multyrama Pf	H 14*			570310	
	H 16*		570320		
	H 18*		570340		
	H 20*		570350		
	H 26*		570370		
	H 32		570380		
	U 40		570790		
	U 50		570795		
	U 63 (PR-3B)	Z4	572837		
	Prandelli Multyrama Pfm	H 16*		570320	
H 18*			570340		
H 20*			570350		
H 26*			570370		
H 32			570380		
TH 16*			570460		
TH 18*			570465		
TH 20*			570470		
TH 26*			570475		
TH 32			570480		
TH 40			570485		
TH 50 (PZ-S)			572400		
TH 16 S (PR-2B)		Z8	574782		
TH 20 S (PR-2B)		Z8	574788		
TH 26 S (PR-2B)		Z8	574794		
TH 32 S (PR-2B)		Z8	574798		
U 16*			570765		
U 18*			570770		
U 20*			570775		
U 40			570790		
U 50		570795			
U 63 (PR-3B)	Z4	572837			

System	Pressing tongs/ pressing rings	Driven by adapter tongs	Art.-No.
PURMO Cleverfit Radial	F 16*		570717
	F 20*		570727
	F 26*		570730
	F 32		570735
	F 16 S (PR-2B)	Z8	574728
	F 20 S (PR-2B)	Z8	574730
	F 26 S (PR-2B)	Z8	574732
	F 32 S (PR-2B)	Z8	574734
	H 16*		570320
	H 20*		570350
	H 26*		570370
	H 32		570380
	TH 14*		570455
	TH 16*		570460
	TH 17*		570462
	TH 20*		570470
	TH 26*		570475
	TH 32		570480
	TH 40		570485
	TH 50 (PZ-S)		572400
	TH 63 (PZ-S)		572405
	TH 16 S (PR-2B)	Z8	574782
	TH 20 S (PR-2B)	Z8	574788
	TH 26 S (PR-2B)	Z8	574794
	TH 32 S (PR-2B)	Z8	574798
U 16*		570765	
U 20*		570775	
U 32		570785	
VP 16*		570910	
VP 20*		570915	
VP 25		570920	

R

Raccorderie Metalliche aesPRES ¹⁾	M 15		570110
	M 18		570120
	M 22		570130
	M 28		570140
	M 35		570150
	M 42 (PR-3S)	Z2	572706
	M 54 (PR-3S)	Z2	572708
	M 15 S (PR-2B)	Z8	574738
	M 18 S (PR-2B)	Z8	574740
	M 22 S (PR-2B)	Z8	574742
Raccorderie Metalliche inoxPRES ¹⁾	M 15		570110
	M 18		570120
	M 22		570130
	M 28		570140
	M 35		570150
	M 42 (PR-3S)	Z2	572706
	M 54 (PR-3S)	Z2	572708
	M 76,1 XL (PR-3S) ⁸⁾	Z7 XL 45 kN ⁴⁾	579101
	M 88,9 G XL (PR-3S) ⁸⁾	Z7 XL 45 kN ⁴⁾	579110
	M 108,0 G XL (PR-3S) ⁸⁾	Z7 XL 45 kN ⁴⁾	579111
Raccorderie Metalliche MARINEPRES ¹⁾	M 15		570110
	M 18		570120
	M 22		570130
	M 28		570140
	M 35		570150
	M 42 (PR-3S)	Z2	572706
	M 54 (PR-3S)	Z2	572708
	M 76,1 XL (PR-3S) ⁸⁾	Z7 XL 45 kN ⁴⁾	579101
	M 88,9 G XL (PR-3S) ⁸⁾	Z7 XL 45 kN ⁴⁾	579110
	M 108,0 G XL (PR-3S) ⁸⁾	Z7 XL 45 kN ⁴⁾	579111

Pressfitting systems for gas installations must only be pressed with pressing tongs/pressing rings which are highlighted in yellow.

Observe the national regulations. Read and observe the instructions for use and the installation instructions of the system provider/manufacturer.

* These pressing tongs also fit the manual radial press REMS Eco-Press. Observe the national regulations.

¹⁾ Only pressing tongs from designation "108" (1st quarter of 2008), "208" (2nd quarter of 2008) etc. can be used. The designation is stamped on every pressing jaw.

²⁾ For this pressfitting system producing a pressing joint with manual radial presses is not permitted.

³⁾ Driven by REMS Power-Press XL ACC.

⁴⁾ Driven by REMS Akku-Press XL 45 kN 22 V ACC.

⁵⁾ For taking suitable pressing inserts.

⁶⁾ Press fittings made of red bronze (Sanpress XL) must be pressed with pressing rings with press contour VR, copper fittings (Profipress XL, Profipress G XL), carbon steel (Prestabo XL) and stainless steel fittings (Sanpress Inox XL, Sanpress Inox G XL) with pressing rings with press contour VF.

⁷⁾ Use pressing rings labelled "M 88.9 G" or "M 108 G" on the three pressing segments for gas installations.

⁸⁾ For making press joints for operating pressure ≤ PN 10.

⁹⁾ For pipes of the EN technical standard. Observe the instructions for use of the system provider/manufacturer.

¹⁰⁾ For pipes of the ASTM technical standard. Observe the instructions for use of the system provider/manufacturer.

The suitability of REMS pressing tools for pressfitting systems: Date 12.10.2022. For the updated situation regarding suitability status check our website: www.rems.de > Downloads > Product catalogues, brochures > REMS Catalogue.

See page 236 for adapter tongs. Pressing tongs/pressing rings for additional pressfitting systems on request.

REMS pressing tongs

REMS pressing rings

Accessories for REMS radial presses (except for REMS Mini-Press) and suitable radial presses of other makes

System	Pressing tongs / pressing rings	Driven by adapter tongs	Art.-No.	
Raccorderie Metalliche steelPRES ¹	M 15		570110	
	M 18		570120	
	M 22		570130	
	M 28		570140	
	M 35		570150	
	M 42 (PR-3S)	Z2	572706	
	M 54 (PR-3S)	Z2	572708	
	M 76,1 XL (PR-3S) ⁽¹⁾	Z7 XL 45 kN ⁽¹⁾	579101	
	M 88,9 G XL (PR-3S) ⁽¹⁾	Z7 XL 45 kN ⁽¹⁾	579110	
	M 108,0 G XL (PR-3S) ⁽¹⁾	Z7 XL 45 kN ⁽¹⁾	579111	
	M 15 S (PR-2B)	Z8	574738	
	M 18 S (PR-2B)	Z8	574740	
	M 22 S (PR-2B)	Z8	574742	
	M 28 S (PR-2B)	Z8	574744	
	M 35 S (PR-2B)	Z8	574746	
	RBM Tita-fix	B 14*		570845
		B 16*		570850
		B 18*		570855
		B 20*		570860
		B 26		570870
F 16*			570717	
F 18*			570720	
F 20*			570727	
F 16 S (PR-2B)		Z8	574728	
F 20 S (PR-2B)		Z8	574730	
H 14*			570310	
H 16*			570320	
H 18*			570340	
H 20*			570350	
H 26*			570370	
H 32			570380	
TH 14*			570455	
TH 16*			570460	
TH 18*			570465	
TH 20*			570470	
TH 26*			570475	
TH 32			570480	
TH 40			570485	
TH 50 (PZ-S)			572400	
TH 63 (PZ-S)			572405	
TH 16 S (PR-2B)		Z8	574782	
TH 20 S (PR-2B)		Z8	574788	
TH 26 S (PR-2B)		Z8	574794	
TH 32 S (PR-2B)		Z8	574798	
U 14*			570760	
U 16*			570765	
U 18*			570770	
U 20*		570775		
RBM Tita-gas	TH 16*		570460	
	TH 20*		570470	
	TH 26*		570475	
	TH 32		570480	
	TH 16 S (PR-2B)	Z8	574782	
	TH 20 S (PR-2B)	Z8	574788	
	TH 26 S (PR-2B)	Z8	574794	
	TH 32 S (PR-2B)	Z8	574798	
Redi Nicoll Fluxo	TH 14*		570455	
	TH 16*		570460	
	TH 18*		570465	
	TH 20*		570470	
	TH 26*		570475	
	TH 32		570480	
	TH 40		570485	
	TH 50 (PZ-S)		572400	
	TH 63 (PZ-S)		572405	
	THz 75 (PR-3B)		572829	
	TH 16 S (PR-2B)	Z8	574782	
	TH 20 S (PR-2B)	Z8	574788	
	TH 26 S (PR-2B)	Z8	574794	
	TH 32 S (PR-2B)	Z8	574798	
Redi Nicoll Fluxo Gas	TH 16*		570460	
	TH 20*		570470	
	TH 26*		570475	
	TH 16 S (PR-2B)	Z8	574782	
	TH 20 S (PR-2B)	Z8	574788	
	TH 26 S (PR-2B)	Z8	574794	
	TH 32 S (PR-2B)	Z8	574798	
	U 14*		570760	
U 16*		570765		
U 18*		570770		
U 20*		570775		
U 25*		570780		
U 32		570785		
U 40		570790		
U 50		570795		
U 63 (PZ-S)		572365		
U 63 (PR-3B)	Z4	572837		
U 75 (PR-3B)	Z4	572828		
RIFENG TH PRESS FITTING (F9)	TH 16*		570460	
	TH 20*		570470	
	TH 25*		570495	
	TH 26*		570475	
	TH 32		570480	
	TH 40		570485	
	TH 50 (PZ-S)		572400	
TH 63 (PZ-S)		572405		
RIQUIER A SERTIR	Rfz 12*		571320	
	Rfz 16*		571325	
	Rfz 20*		571330	
	Rfz 25		571335	
	RN 14*		572672	
Roth PressCheck	RN 16		572670	
	RN 17*		572674	
	RN 20*		572676	
	RN 25/26		572678	
	RN 32		572680	
	RN 40 (PR-3S)	Z2	572714	
	RN 50 (PR-3S)	Z2	572716	
	RNz 63 (PR-3B)	Z4	572836	

System	Pressing tongs / pressing rings	Driven by adapter tongs	Art.-No.	
RUBINETTERIE Bresciane Bonomi TURBO CuNi	M 15		570110	
	M 18		570120	
	M 22		570130	
	M 28		570140	
	M 35		570150	
	M 42 (PR-3S)	Z2	572706	
	M 54 (PR-3S)	Z2	572708	
	M 76,1 XL (PR-3S)	Z6 XL ⁽²⁾ / Z7 XL 45 kN ⁽¹⁾	579101	
	M 88,9 G XL (PR-3S)	Z6 XL ⁽²⁾ / Z7 XL 45 kN ⁽¹⁾	579110	
	M 108,0 G XL (PR-3S)	Z6 XL ⁽²⁾ / Z7 XL 45 kN ⁽¹⁾	579111	
	M 15 S (PR-2B)	Z8	574738	
	M 18 S (PR-2B)	Z8	574740	
	M 22 S (PR-2B)	Z8	574742	
	M 28 S (PR-2B)	Z8	574744	
	M 35 S (PR-2B)	Z8	574746	
	RUBINETTERIE Bresciane Bonomi TURBO INOX	M 15		570110
		M 18		570120
		M 22		570130
		M 28		570140
		M 35		570150
M 42 (PR-3S)		Z2	572706	
M 54 (PR-3S)		Z2	572708	
M 76,1 XL (PR-3S)		Z6 XL ⁽²⁾ / Z7 XL 45 kN ⁽¹⁾	579101	
M 88,9 G XL (PR-3S)		Z6 XL ⁽²⁾ / Z7 XL 45 kN ⁽¹⁾	579110	
M 108,0 G XL (PR-3S)		Z6 XL ⁽²⁾ / Z7 XL 45 kN ⁽¹⁾	579111	
M 15 S (PR-2B)		Z8	574738	
M 18 S (PR-2B)		Z8	574740	
M 22 S (PR-2B)		Z8	574742	
M 28 S (PR-2B)		Z8	574744	
M 35 S (PR-2B)	Z8	574746		
RUBINETTERIE Bresciane Bonomi TURBO INOX GAS	M 15		570110	
	M 18		570120	
	M 22		570130	
	M 28		570140	
	M 35		570150	
	M 42 (PR-3S)	Z2	572706	
	M 54 (PR-3S)	Z2	572708	
	M 15 S (PR-2B)	Z8	574738	
	M 18 S (PR-2B)	Z8	574740	
	M 22 S (PR-2B)	Z8	574742	
	M 28 S (PR-2B)	Z8	574744	
	M 35 S (PR-2B)	Z8	574746	
	RUBINETTERIE Bresciane Bonomi TURBO STEEL	M 15		570110
		M 18		570120
M 22			570130	
M 28			570140	
M 35			570150	
M 42 (PR-3S)		Z2	572706	
M 54 (PR-3S)		Z2	572708	
M 15 S (PR-2B)		Z8	574738	
M 18 S (PR-2B)		Z8	574740	
M 22 S (PR-2B)		Z8	574742	
M 28 S (PR-2B)		Z8	574744	
M 35 S (PR-2B)		Z8	574746	
RUBINETTERIE Bresciane Bonomi TURBO PRESS		B 14*		570845
		B 16*		570850
	B 18*		570855	
	B 20*		570860	
	B 26		570870	
	B 32		570880	
	H 14*		570310	
	H 16*		570320	
	H 18*		570340	
	H 20*		570350	
	H 26*		570370	
	H 32		570380	
	TH 14*		570455	
	TH 16*		570460	
	TH 18*		570465	
	TH 20*		570470	
	TH 26*		570475	
	TH 32		570480	
	TH 40		570485	
	TH 50 (PZ-S)		572400	
TH 63 (PZ-S)		572405		
TH 16 S (PR-2B)	Z8	574782		
TH 20 S (PR-2B)	Z8	574788		
TH 26 S (PR-2B)	Z8	574794		
TH 32 S (PR-2B)	Z8	574798		
U 14*		570760		
U 16*		570765		
U 18*		570770		
U 20*		570775		
C 26*		570750		
U 32		570785		
RUBINETTERIE Bresciane Bonomi TURBO PRESS GAS	TH 16*		570460	
	TH 20*		570470	
	TH 26*		570475	
	TH 32		570480	
	TH 40		570485	
	TH 50 (PZ-S)		572400	
	TH 63 (PZ-S)		572405	
	TH 16 S (PR-2B)	Z8	574782	
TH 20 S (PR-2B)	Z8	574788		
TH 26 S (PR-2B)	Z8	574794		
TH 32 S (PR-2B)	Z8	574798		
S				
Sa.MI plastic	TH 14*		570455	
	TH 16*		570460	
	TH 18*		570465	
	TH 20*		570470	
	TH 26*		570475	
	TH 32		570480	
	TH 40		570485	
	TH 50 (PZ-S)		572400	
	TH 63 (PZ-S)		572405	
	TH 16 S (PR-2B)	Z8	574782	
TH 20 S (PR-2B)	Z8	574788		
TH 26 S (PR-2B)	Z8	574794		
TH 32 S (PR-2B)	Z8	574798		

REMS pressing tongs REMS pressing rings

Accessories for REMS radial presses (except for REMS Mini-Press) and suitable radial presses of other makes

System	Pressing tongs / pressing rings	Driven by adapter tongs	Art.-No.	
Sa, MI plastic Multistrato Gas	TH 16*		570460	
	TH 20*		570470	
	TH 26*		570475	
	TH 32		570480	
	TH 16 S (PR-2B)	28	574782	
	TH 20 S (PR-2B)	28	574788	
	TH 26 S (PR-2B)	28	574794	
	TH 32 S (PR-2B)	28	574798	
	SANHA 3fit-Press Pb-free Serie 25000	B 16*		570850
		B 20*		570860
B 26			570870	
B 32			570880	
F 16*			570717	
F 20*			570727	
F 26*			570730	
F 32			570735	
Fz 40			570742	
Fz 50			570747	
F 63 (PZ-S)			572385	
F 16 S (PR-2B)		28	574728	
F 20 S (PR-2B)		28	574730	
F 26 S (PR-2B)		28	574732	
F 32 S (PR-2B)		28	574734	
H 16*			570320	
H 20*			570350	
H 26*			570370	
H 32			570380	
H 40 (PZ-4G)			570390	
TH 16*			570460	
TH 20*			570470	
TH 26*			570475	
TH 32			570480	
TH 40			570485	
TH 50 (PZ-S)			572400	
TH 63 (PZ-S)			572405	
TH 16 S (PR-2B)		28	574782	
TH 20 S (PR-2B)		28	574788	
TH 26 S (PR-2B)		28	574794	
TH 32 S (PR-2B)		28	574798	
U 16*			570765	
U 20*			570775	
C 26*			570750	
U 32			570785	
U 40			570790	
U 50			570795	
U 63 (PR-3B)		24	572837	
U 63 (PZ-S)			572365	
SANHA 3fit-Press PPSU Serie 35000		B 16*		570850
	B 20*		570860	
	B 26		570870	
	B 32		570880	
	F 16*		570717	
	F 20*		570727	
	F 26*		570730	
	F 32		570735	
	F 16 S (PR-2B)	28	574728	
	F 20 S (PR-2B)	28	574730	
	F 26 S (PR-2B)	28	574732	
	F 32 S (PR-2B)	28	574734	
	H 16*		570320	
	H 20*		570350	
	H 26*		570370	
	H 32		570380	
	TH 16*		570460	
	TH 20*		570470	
	TH 26*		570475	
	TH 32		570480	
	TH 40		570485	
	TH 50 (PZ-S)		572400	
	TH 63 (PZ-S)		572405	
	TH 16 S (PR-2B)	28	574782	
	TH 20 S (PR-2B)	28	574788	
	TH 26 S (PR-2B)	28	574794	
	TH 32 S (PR-2B)	28	574798	
	U 16*		570765	
	U 20*		570775	
	C 26*		570750	
	U 32		570785	

System	Pressing tongs / pressing rings	Driven by adapter tongs	Art.-No.	
SANHA Heavy Steel Press	VMP ½" (OD 21,3 mm)		571762	
	VMPz ¾" (OD 26,9 mm)		571764	
	VMPz 1" (OD 33,7 mm)		571767	
	VMPz 1¼" (PZ-S) (OD 42,4 mm)		572413	
	VMPz 1½" (PR-3B) (OD 48,3 mm)	25	572844	
SANHA Heavy Steel Press Gas ¹⁾	VMPz 2" (PR-3B) (OD 60,3 mm)	25	572845	
	VMP ½" (OD 21,3 mm)		571762	
	VMPz ¾" (OD 26,9 mm)		571764	
	VMPz 1" (OD 33,7 mm)		571767	
	VMPz 1¼" (PZ-S) (OD 42,4 mm)		572413	
SANHA-NiroSan Gas Presssystem Serie 17000	VMPz 1½" (PR-3B) (OD 48,3 mm)	25	572844	
	VMPz 2" (PR-3B) (OD 60,3 mm)	25	572845	
	SA 15		570935	
	SA 18		570940	
	SA 22		570945	
SANHA-NiroSan Industry Presssystem Serie 18000	SA 28		570950	
	SA 35		570955	
	M 15		570110	
	M 18		570120	
	M 22		570130	
	M 28		570140	
	M 35		570150	
	M 42 (PR-3S)	22	572706	
	M 54 (PR-3S)	22	572708	
	M 76,1 XL (PR-3S)	27 XL 45 kN ⁴⁾	579101	
	M 88,9 G XL (PR-3S) ⁷⁾	27 XL 45 kN ⁴⁾	579110	
	M 108,0 G XL (PR-3S) ⁷⁾	27 XL 45 kN ⁴⁾	579111	
	M 15 S (PR-2B)	28	574738	
	M 18 S (PR-2B)	28	574740	
	M 22 S (PR-2B)	28	574742	
	M 28 S (PR-2B)	28	574744	
	M 35 S (PR-2B)	28	574746	
	V 15		570115	
	V 18		570125	
	V 22		570135	
	V 28		570145	
	V 35		570155	
	V 42		570165	
	V 42 (PR-2B)	22	572850	
	V 54		570175	
	V 54 (PR-2B)	22	572851	
	V 15 S (PR-2B)	28	574752	
	V 18 S (PR-2B)	28	574756	
	V 22 S (PR-2B)	28	574758	
	V 28 S (PR-2B)	28	574760	
	V 35 S (PR-2B)	28	574762	
	SANHA-NiroSan Industry Presssystem Serie 18000	SA 15		570935
		SA 18		570940
		SA 22		570945
		SA 28		570950
		SA 35		570955
		M 15		570110
		M 18		570120
		M 22		570130
		M 28		570140
M 35			570150	
M 42 (PR-3S)		22	572706	
M 54 (PR-3S)		22	572708	
XP 64,0 XL (PR-3S)		26 XL ³⁾ / 27 XL 45 kN ⁴⁾	579100	
M 76,1 XL (PR-3S)		26 XL ³⁾ / 27 XL 45 kN ⁴⁾	579101	
M 88,9 G XL (PR-3S)		26 XL ³⁾ / 27 XL 45 kN ⁴⁾	579110	
M 108,0 G XL (PR-3S)		26 XL ³⁾ / 27 XL 45 kN ⁴⁾	579111	
M 15 S (PR-2B)		28	574738	
M 18 S (PR-2B)		28	574740	
M 22 S (PR-2B)		28	574742	
M 28 S (PR-2B)		28	574744	
M 35 S (PR-2B)		28	574746	
V 15			570115	
V 18			570125	
V 22			570135	
V 28			570145	
V 35			570155	
V 42			570165	
V 42 (PR-2B)		22	572850	
V 54			570175	
V 54 (PR-2B)		22	572851	
V 15 S (PR-2B)		28	574752	
V 18 S (PR-2B)		28	574756	
V 22 S (PR-2B)		28	574758	
V 28 S (PR-2B)		28	574760	
V 35 S (PR-2B)		28	574762	

Pressfitting systems for gas installations must only be pressed with pressing tongs/pressing rings which are highlighted in yellow.

Observe the national regulations. Read and observe the instructions for use and the installation instructions of the system provider/manufacturer.

* These pressing tongs also fit the manual radial press REMS Eco-Press. Observe the national regulations.

¹⁾ Only pressing tongs from designation "108" (1st quarter of 2008), "208" (2nd quarter of 2008) etc. can be used. The designation is stamped on every pressing jaw.

²⁾ For this pressfitting system producing a pressing joint with manual radial presses is not permitted.

³⁾ Driven by REMS Power-Press XL ACC.

⁴⁾ Driven by REMS Akku-Press XL 45 kN 22 V ACC.

⁵⁾ For taking suitable pressing inserts.

⁶⁾ Press fittings made of red bronze (Sanpress XL) must be pressed with pressing rings with press contour VR, copper fittings (Profipress XL, Profipress G XL), carbon steel (Prestabo XL) and stainless steel fittings (Sanpress Inox XL, Sanpress Inox G XL) with pressing rings with press contour VF.

⁷⁾ Use pressing rings labelled "M 88.9 G" or "M 108 G" on the three pressing segments for gas installations.

⁸⁾ For making press joints for operating pressure ≤ PN 10.

⁹⁾ For pipes of the EN technical standard. Observe the instructions for use of the system provider/manufacturer.

¹⁰⁾ For pipes of the ASTM technical standard. Observe the instructions for use of the system provider/manufacturer.

The suitability of REMS pressing tools for pressfitting systems: Date 12.10.2022. For the updated situation regarding suitability status check our website:

www.rems.de > Downloads > Product catalogues, brochures > REMS Catalogue.

See page 236 for adapter tongs. Pressing tongs/pressing rings for additional pressfitting systems on request.

REMS pressing tongs

REMS pressing rings

Accessories for REMS radial presses (except for REMS Mini-Press) and suitable radial presses of other makes

System	Pressing tongs / pressing rings	Driven by adapter tongs	Art.-No.	
SANHA-NiroSan-Presssystem Serie 9000	SA 15		570935	
	SA 18		570940	
	SA 22		570945	
	SA 28		570950	
	SA 35		570955	
	M 15		570110	
	M 18		570120	
	M 22		570130	
	M 28		570140	
	M 35		570150	
	M 42 (PR-3S)	Z2	572706	
	M 54 (PR-3S)	Z2	572708	
	XP 64,0 XL (PR-3S)	Z6 XL ³⁾ / Z7 XL 45 kN ⁴⁾	579100	
	M 76,1 XL (PR-3S)	Z6 XL ³⁾ / Z7 XL 45 kN ⁴⁾	579101	
	M 88,9 G XL (PR-3S)	Z6 XL ³⁾ / Z7 XL 45 kN ⁴⁾	579110	
	M 108,0 G XL (PR-3S)	Z6 XL ³⁾ / Z7 XL 45 kN ⁴⁾	579111	
	M 15 S (PR-2B)	Z8	574738	
	M 18 S (PR-2B)	Z8	574740	
	M 22 S (PR-2B)	Z8	574742	
	M 28 S (PR-2B)	Z8	574744	
	M 35 S (PR-2B)	Z8	574746	
	V 15		570115	
	V 18		570125	
	V 22		570135	
	V 28		570145	
	V 35		570155	
	V 42		570165	
	V 42 (PR-2B)	Z2	572850	
	V 54		570175	
	V 54 (PR-2B)	Z2	572851	
	V 15 S (PR-2B)	Z8	574752	
	V 18 S (PR-2B)	Z8	574756	
	V 22 S (PR-2B)	Z8	574758	
	V 28 S (PR-2B)	Z8	574760	
	V 35 S (PR-2B)	Z8	574762	
	SANHA-NiroSan SF Presssystem Serie 19000 (silicone free)	SA 15		570935
		SA 18		570940
		SA 22		570945
SA 28			570950	
SA 35			570955	
M 15			570110	
M 18			570120	
M 22			570130	
M 28			570140	
M 35			570150	
M 42 (PR-3S)		Z2	572706	
M 54 (PR-3S)		Z2	572708	
M 76,1 XL (PR-3S)		Z6 XL ³⁾ / Z7 XL 45 kN ⁴⁾	579101	
M 88,9 G XL (PR-3S)		Z6 XL ³⁾ / Z7 XL 45 kN ⁴⁾	579110	
M 108,0 G XL (PR-3S)		Z6 XL ³⁾ / Z7 XL 45 kN ⁴⁾	579111	
M 15 S (PR-2B)		Z8	574738	
M 18 S (PR-2B)		Z8	574740	
M 22 S (PR-2B)		Z8	574742	
M 28 S (PR-2B)		Z8	574744	
M 35 S (PR-2B)		Z8	574746	
V 15			570115	
V 18			570125	
V 22			570135	
V 28			570145	
V 35			570155	
V 42			570165	
V 42 (PR-2B)		Z2	572850	
V 54			570175	
V 54 (PR-2B)		Z2	572851	
V 15 S (PR-2B)		Z8	574752	
V 18 S (PR-2B)		Z8	574756	
V 22 S (PR-2B)		Z8	574758	
V 28 S (PR-2B)		Z8	574760	
V 35 S (PR-2B)		Z8	574762	
SANHA NiroTherm Serie 91000		SA 15		570935
		SA 18		570940
		SA 22		570945
		SA 28		570950
	SA 35		570955	
	M 15		570110	
	M 18		570120	
	M 22		570130	
	M 28		570140	
	M 35		570150	
	M 42 (PR-3S)	Z2	572706	
	M 54 (PR-3S)	Z2	572708	
	M 76,1 XL (PR-3S)	Z6 XL ³⁾ / Z7 XL 45 kN ⁴⁾	579101	
	M 88,9 G XL (PR-3S)	Z6 XL ³⁾ / Z7 XL 45 kN ⁴⁾	579110	
	M 108,0 G XL (PR-3S)	Z6 XL ³⁾ / Z7 XL 45 kN ⁴⁾	579111	
	M 15 S (PR-2B)	Z8	574738	
	M 18 S (PR-2B)	Z8	574740	
	M 22 S (PR-2B)	Z8	574742	
	M 28 S (PR-2B)	Z8	574744	
	M 35 S (PR-2B)	Z8	574746	
	V 15		570115	
	V 18		570125	
	V 22		570135	
	V 28		570145	
	V 35		570155	
	V 42		570165	
	V 42 (PR-2B)	Z2	572850	
	V 54		570175	
	V 54 (PR-2B)	Z2	572851	
	V 15 S (PR-2B)	Z8	574752	
	V 18 S (PR-2B)	Z8	574756	
	V 22 S (PR-2B)	Z8	574758	
	V 28 S (PR-2B)	Z8	574760	
	V 35 S (PR-2B)	Z8	574762	

System	Pressing tongs / pressing rings	Driven by adapter tongs	Art.-No.	
SANHA NiroTherm Industry Serie 98000	SA 15		570935	
	SA 18		570940	
	SA 22		570945	
	SA 28		570950	
	SA 35		570955	
	M 15		570110	
	M 18		570120	
	M 22		570130	
	M 28		570140	
	M 35		570150	
	M 42 (PR-3S)	Z2	572706	
	M 54 (PR-3S)	Z2	572708	
	M 76,1 XL (PR-3S)	Z6 XL ³⁾ / Z7 XL 45 kN ⁴⁾	579101	
	M 88,9 G XL (PR-3S)	Z6 XL ³⁾ / Z7 XL 45 kN ⁴⁾	579110	
	M 108,0 G XL (PR-3S)	Z6 XL ³⁾ / Z7 XL 45 kN ⁴⁾	579111	
	M 15 S (PR-2B)	Z8	574738	
	M 18 S (PR-2B)	Z8	574740	
	M 22 S (PR-2B)	Z8	574742	
	M 28 S (PR-2B)	Z8	574744	
	M 35 S (PR-2B)	Z8	574746	
	V 15		570115	
	V 18		570125	
	V 22		570135	
	V 28		570145	
	V 35		570155	
	V 42		570165	
	V 42 (PR-2B)	Z2	572850	
	V 54		570175	
	V 54 (PR-2B)	Z2	572851	
	V 15 S (PR-2B)	Z8	574752	
	V 18 S (PR-2B)	Z8	574756	
	V 22 S (PR-2B)	Z8	574758	
	V 28 S (PR-2B)	Z8	574760	
	V 35 S (PR-2B)	Z8	574762	
	SANHA-Press Chrom Serie 16000	SA 12		570930
		SA 15		570935
		SA 18		570940
		SA 22		570945
SA 28			570950	
M 12			570100	
M 15			570110	
M 18			570120	
M 22			570130	
M 28			570140	
M 12 S (PR-2B)		Z8	574736	
M 15 S (PR-2B)		Z8	574738	
M 18 S (PR-2B)		Z8	574740	
M 22 S (PR-2B)		Z8	574742	
M 28 S (PR-2B)		Z8	574744	
V 12			570107	
V 15			570115	
V 18			570125	
V 22			570135	
V 28			570145	
V 12 S (PR-2B)		Z8	574748	
V 15 S (PR-2B)		Z8	574752	
V 18 S (PR-2B)		Z8	574756	
V 22 S (PR-2B)		Z8	574758	
V 28 S (PR-2B)		Z8	574760	
SANHA-Press GAS Pressfittings Serie 10000/ Serie 11000		SA 12		570930
		SA 14		570932
		SA 15		570935
		SA 16		570937
		SA 18		570940
		SA 22		570945
		SA 28		570950
		SA 35		570955
		M 12		570100
		M 15		570110
		M 18		570120
		M 22		570130
		M 28		570140
	M 35		570150	
	M 42 (PR-3S)	Z2	572706	
	M 54 (PR-3S)	Z2	572708	
	M 12 S (PR-2B)	Z8	574736	
	M 15 S (PR-2B)	Z8	574738	
	M 18 S (PR-2B)	Z8	574740	
	M 22 S (PR-2B)	Z8	574742	
	M 28 S (PR-2B)	Z8	574744	
	M 35 S (PR-2B)	Z8	574746	
	V 12		570107	
	V 14		570112	
	VG 14		570132	
	V 15		570115	
	V 16		570117	
	VG 16		570137	
	V 18		570125	
	V 22		570135	
	V 28		570145	
	V 35		570155	
	V 42		570165	
	V 42 (PR-2B)	Z2	572850	
	V 54		570175	
	V 54 (PR-2B)	Z2	572851	
	V 12 S (PR-2B)	Z8	574748	
	VG 14 S (PR-2B)	Z8	574750	
V 15 S (PR-2B)	Z8	574752		
VG 16 S (PR-2B)	Z8	574754		
V 18 S (PR-2B)	Z8	574756		
V 22 S (PR-2B)	Z8	574758		
V 28 S (PR-2B)	Z8	574760		
V 35 S (PR-2B)	Z8	574762		

REMS pressing tongs REMS pressing rings

Accessories for REMS radial presses (except for REMS Mini-Press) and suitable radial presses of other makes

System	Pressing tongs / pressing rings	Driven by adapter tongs	Art.-No.	System	Pressing tongs / pressing rings	Driven by adapter tongs	Art.-No.
SANHA-Press Pressfittings Serie 6000	SA 12		570930	SANHA PURAPRESS Serie 8000	SA 12		570930
	SA 14		570932		SA 14		570932
	SA 15		570935		SA 15		570935
	SA 16		570937		SA 16		570937
	SA 18		570940		SA 18		570940
	SA 22		570945		SA 22		570945
	SA 28		570950		SA 28		570950
	SA 35		570955		SA 35		570955
	M 12		570100		M 12		570100
	M 15		570110		M 15 ¹⁾		570110
	M 18		570120		M 18 ¹⁾		570120
	M 22		570130		M 22 ¹⁾		570130
	M 28		570140		M 28 ¹⁾		570140
	M 35		570150		M 35 ¹⁾		570150
	M 42 (PR-3S)	Z2	572706		M 42 (PR-3S)	Z2	572706
	M 54 (PR-3S)	Z2	572708		M 54 (PR-3S)	Z2	572708
	XP 64,0 XL (PR-3S)	Z6 XL ³⁾ / Z7 XL 45kN ⁴⁾	579100		XP 64,0 XL (PR-3S)	Z6 XL ³⁾ / Z7 XL 45kN ⁴⁾	579100
	XP 66,7 XL (PR-3S)	Z6 XL ³⁾ / Z7 XL 45kN ⁴⁾	579108		XP 66,7 XL (PR-3S)	Z6 XL ³⁾ / Z7 XL 45kN ⁴⁾	579108
	M 66,7 XL (PR-3S)	Z6 XL ³⁾ / Z7 XL 45kN ⁴⁾	579107		M 66,7 XL (PR-3S)	Z6 XL ³⁾ / Z7 XL 45kN ⁴⁾	579107
	M 76,1 XL (PR-3S)	Z6 XL ³⁾ / Z7 XL 45kN ⁴⁾	579101		M 76,1 XL (PR-3S)	Z6 XL ³⁾ / Z7 XL 45kN ⁴⁾	579101
	M 88,9 G XL (PR-3S)	Z6 XL ³⁾ / Z7 XL 45kN ⁴⁾	579110		M 88,9 G XL (PR-3S)	Z6 XL ³⁾ / Z7 XL 45kN ⁴⁾	579110
	M 108,0 G XL (PR-3S)	Z6 XL ³⁾ / Z7 XL 45kN ⁴⁾	579111		M 108,0 G XL (PR-3S)	Z6 XL ³⁾ / Z7 XL 45kN ⁴⁾	579111
	M 12 S (PR-2B)	Z8	574736		M 12 S (PR-2B)	Z8	574736
	M 15 S (PR-2B)	Z8	574738		M 15 S (PR-2B)	Z8	574738
	M 18 S (PR-2B)	Z8	574740		M 18 S (PR-2B)	Z8	574740
	M 22 S (PR-2B)	Z8	574742		M 22 S (PR-2B)	Z8	574742
	M 28 S (PR-2B)	Z8	574744		M 28 S (PR-2B)	Z8	574744
	M 35 S (PR-2B)	Z8	574746		M 35 S (PR-2B)	Z8	574746
	V 12		570107		V 12		570107
	V 14		570112		V 14		570112
	VG 14		570132		VG 14		570132
	V 15		570115		V 15		570115
	V 16		570117		V 16		570117
	VG 16		570137		VG 16		570137
	V 18		570125		V 18		570125
	V 22		570135		V 22		570135
	V 28		570145		V 28		570145
	V 35		570155		V 35		570155
	V 42		570165		V 42		570165
	V 42 (PR-2B)	Z2	572850		V 42 (PR-2B)	Z2	572850
	V 54		570175		V 54		570175
	V 54 (PR-2B)	Z2	572851		V 54 (PR-2B)	Z2	572851
	V 12 S (PR-2B)	Z8	574748		V 12 S (PR-2B)	Z8	574748
VG 14 S (PR-2B)	Z8	574750	VG 14 S (PR-2B)	Z8	574750		
V 15 S (PR-2B)	Z8	574752	V 15 S (PR-2B)	Z8	574752		
VG 16 S (PR-2B)	Z8	574754	VG 16 S (PR-2B)	Z8	574754		
V 18 S (PR-2B)	Z8	574756	V 18 S (PR-2B)	Z8	574756		
V 22 S (PR-2B)	Z8	574758	V 22 S (PR-2B)	Z8	574758		
V 28 S (PR-2B)	Z8	574760	V 28 S (PR-2B)	Z8	574760		
V 35 S (PR-2B)	Z8	574762	V 35 S (PR-2B)	Z8	574762		
SANHA-Press SOLAR Pressfittings Serie 12000/ Serie 13000	SA 12		570930	SANHA-Therm Serie 24000	SA 12		570930
	SA 15		570935		SA 15		570935
	SA 18		570940		SA 18		570940
	SA 22		570945		SA 22		570945
	SA 28		570950		SA 28		570950
	SA 35		570955		SA 35		570955
	M 12		570100		M 12		570100
	M 15		570110		M 15		570110
	M 18		570120		M 18		570120
	M 22		570130		M 22		570130
	M 28		570140		M 28		570140
	M 35		570150		M 35		570150
	M 42 (PR-3S)	Z2	572706		M 42 (PR-3S)	Z2	572706
	M 54 (PR-3S)	Z2	572708		M 54 (PR-3S)	Z2	572708
	XP 64,0 XL (PR-3S)	Z6 XL ³⁾ / Z7 XL 45kN ⁴⁾	579100		XP 66,7 XL (PR-3S)	Z6 XL ³⁾ / Z7 XL 45kN ⁴⁾	579108
	XP 66,7 XL (PR-3S)	Z6 XL ³⁾ / Z7 XL 45kN ⁴⁾	579108		M 66,7 XL (PR-3S)	Z6 XL ³⁾ / Z7 XL 45kN ⁴⁾	579107
	M 66,7 XL (PR-3S)	Z6 XL ³⁾ / Z7 XL 45kN ⁴⁾	579107		M 76,1 XL (PR-3S)	Z6 XL ³⁾ / Z7 XL 45kN ⁴⁾	579101
	M 76,1 XL (PR-3S)	Z6 XL ³⁾ / Z7 XL 45kN ⁴⁾	579101		M 88,9 G XL (PR-3S)	Z6 XL ³⁾ / Z7 XL 45kN ⁴⁾	579110
	M 88,9 G XL (PR-3S)	Z6 XL ³⁾ / Z7 XL 45kN ⁴⁾	579110		M 108,0 G XL (PR-3S)	Z6 XL ³⁾ / Z7 XL 45kN ⁴⁾	579111
	M 108,0 G XL (PR-3S)	Z6 XL ³⁾ / Z7 XL 45kN ⁴⁾	579111		M 12 S (PR-2B)	Z8	574736
	M 12 S (PR-2B)	Z8	574736		M 15 S (PR-2B)	Z8	574738
	M 15 S (PR-2B)	Z8	574738		M 18 S (PR-2B)	Z8	574740
	M 18 S (PR-2B)	Z8	574740		M 22 S (PR-2B)	Z8	574742
	M 22 S (PR-2B)	Z8	574742		M 28 S (PR-2B)	Z8	574744
	M 28 S (PR-2B)	Z8	574744		M 35 S (PR-2B)	Z8	574746
	M 35 S (PR-2B)	Z8	574746		V 12		570107
	V 12		570107		V 15		570115
	V 15		570115		V 18		570125
	V 18		570125		V 22		570135
	V 22		570135		V 28		570145
	V 28		570145		V 35		570155
	V 35		570155		V 42		570165
	V 42		570165		V 42 (PR-2B)	Z2	572850
	V 42 (PR-2B)	Z2	572850		V 54		570175
	V 54		570175		V 54 (PR-2B)	Z2	572851
	V 54 (PR-2B)	Z2	572851		V 12 S (PR-2B)	Z8	574748
	V 12 S (PR-2B)	Z8	574748		V 15 S (PR-2B)	Z8	574752
	V 15 S (PR-2B)	Z8	574752		V 18 S (PR-2B)	Z8	574756
	V 18 S (PR-2B)	Z8	574756		V 22 S (PR-2B)	Z8	574758
	V 22 S (PR-2B)	Z8	574758		V 28 S (PR-2B)	Z8	574760
	V 28 S (PR-2B)	Z8	574760		V 35 S (PR-2B)	Z8	574762
	V 35 S (PR-2B)	Z8	574762				

Pressfitting systems for gas installations must only be pressed with pressing tongs/pressing rings which are highlighted in yellow.

Observe the national regulations. Read and observe the instructions for use and the installation instructions of the system provider/manufacturer.

* These pressing tongs also fit the manual radial press REMS Eco-Press. Observe the national regulations.

¹⁾ Only pressing tongs from designation "108" (1st quarter of 2008), "208" (2nd quarter of 2008) etc. can be used. The designation is stamped on every pressing jaw.

²⁾ For this pressfitting system producing a pressing joint with manual radial presses is not permitted.

³⁾ Driven by REMS Power-Press XL ACC.

⁴⁾ Driven by REMS Akku-Press XL 45 kN 22 V ACC.

⁵⁾ For taking suitable pressing inserts.

⁶⁾ Press fittings made of red bronze (Sanpress XL) must be pressed with pressing rings with press contour VR, copper fittings (Profipress XL, Profipress G XL), carbon steel (Prestabo XL) and stainless steel fittings (Sanpress Inox XL, Sanpress Inox G XL) with pressing rings with press contour VF.

⁷⁾ Use pressing rings labelled "M 88.9 G" or "M 108 G" on the three pressing segments for gas installations.

⁸⁾ For making press joints for operating pressure ≤ PN 10.

⁹⁾ For pipes of the EN technical standard. Observe the instructions for use of the system provider/manufacturer.

¹⁰⁾ For pipes of the ASTM technical standard. Observe the instructions for use of the system provider/manufacturer.

The suitability of REMS pressing tools for pressfitting systems: Date 12.10.2022. For the updated situation regarding suitability status check our website:

www.rems.de > Downloads > Product catalogues, brochures > REMS Catalogue.

See page 236 for adapter tongs. Pressing tongs/pressing rings for additional pressfitting systems on request.

REMS pressing tongs REMS pressing rings

Accessories for REMS radial presses (except for REMS Mini-Press)
and suitable radial presses of other makes

System	Pressing tongs / pressing rings	Driven by adapter tongs	Art.-No.	
SANHA-Therm Industry Serie 28000	SA 12		570930	
	SA 15		570935	
	SA 18		570940	
	SA 22		570945	
	SA 28		570950	
	SA 35		570955	
	M 12		570100	
	M 15		570110	
	M 18		570120	
	M 22		570130	
	M 28		570140	
	M 35		570150	
	M 42 (PR-3S)	Z2	572706	
	M 54 (PR-3S)	Z2	572708	
	XP 66,7 XL (PR-3S)	Z6 XL ³⁾ / Z7 XL 45 kN ⁴⁾	579108	
	M 66,7 XL (PR-3S)	Z6 XL ³⁾ / Z7 XL 45 kN ⁴⁾	579107	
	M 76,1 XL (PR-3S)	Z6 XL ³⁾ / Z7 XL 45 kN ⁴⁾	579101	
	M 88,9 G XL (PR-3S)	Z6 XL ³⁾ / Z7 XL 45 kN ⁴⁾	579110	
	M 108,0 G XL (PR-3S)	Z6 XL ³⁾ / Z7 XL 45 kN ⁴⁾	579111	
	M 12 S (PR-2B)	Z8	574736	
	M 15 S (PR-2B)	Z8	574738	
	M 18 S (PR-2B)	Z8	574740	
	M 22 S (PR-2B)	Z8	574742	
	M 28 S (PR-2B)	Z8	574744	
	M 35 S (PR-2B)	Z8	574746	
	V 12		570107	
	V 15		570115	
	V 18		570125	
	V 22		570135	
	V 28		570145	
	V 35		570155	
	V 42		570165	
	V 42 (PR-2B)	Z2	572850	
	V 54		570175	
	V 54 (PR-2B)	Z2	572851	
	V 12 S (PR-2B)	Z8	574748	
	V 15 S (PR-2B)	Z8	574752	
	V 18 S (PR-2B)	Z8	574756	
	V 22 S (PR-2B)	Z8	574758	
	V 28 S (PR-2B)	Z8	574760	
	V 35 S (PR-2B)	Z8	574762	
	SANITOP PERMATUBO INOX	M 15		570110
		M 18 ¹⁾		570120
M 22			570130	
M 28 ¹⁾			570140	
M 35			570150	
M 35 (PR-3S)		Z2	572727	
M 42 (PZ-4G)			570160	
M 54 (PZ-4G)			570170	
M 42 (PR-3S)		Z2	572706	
M 54 (PR-3S)		Z2	572708	
M 76,1 XL (PR-3S)		Z6 XL ³⁾ / Z7 XL 45 kN ⁴⁾	579101	
M 88,9 G XL (PR-3S)		Z6 XL ³⁾ / Z7 XL 45 kN ⁴⁾	579110	
M 108,0 G XL (PR-3S)		Z6 XL ³⁾ / Z7 XL 45 kN ⁴⁾	579111	
M 15 S (PR-2B)		Z8	574738	
M 18 S (PR-2B)		Z8	574740	
M 22 S (PR-2B)	Z8	574742		
M 28 S (PR-2B)	Z8	574744		
M 35 S (PR-2B)	Z8	574746		
SANPRO THPRESS	TH 16*		570460	
	TH 20*		570470	
	TH 26*		570475	
	TH 32		570480	
	TH 16 S (PR-2B)	Z8	574782	
	TH 20 S (PR-2B)	Z8	574788	
	TH 26 S (PR-2B)	Z8	574794	
	TH 32 S (PR-2B)	Z8	574798	
	SATEC SK VITerm	TH 16*		570460
		TH 18*		570465
TH 20*			570470	
TH 26*			570475	
TH 32			570480	
U 40			570790	
U 50			570795	
U 63 (PZ-S)			572365	
SAVEUR REFLEX PEX Water	TH 16*		570460	
	TH 20*		570470	
	TH 25*		570495	
	TH 32		570480	
SAVEUR REFLEX PEX-AL-PEX Gas	TH 16*		570460	
	TH 20*		570470	
	TH 25*		570495	
	TH 32		570480	
Schütz duo-flex tri-o-flex	TH 14*		570455	
	TH 16*		570460	
	TH 17*		570462	
	TH 20*		570470	
	TH 25*		570495	
	TH 16 S (PR-2B)	Z8	574782	
TH 20 S (PR-2B)	Z8	574788		

System	Pressing tongs / pressing rings	Driven by adapter tongs	Art.-No.	
Schwer Fittings AQUApress	M 12		570100	
	M 15		570110	
	M 18		570120	
	M 22		570130	
	M 28		570140	
	M 35		570150	
	M 42 (PZ-4G)		570160	
	M 54 (PZ-4G)		570170	
	M 42 (PR-3S)	Z2	572706	
	M 54 (PR-3S)	Z2	572708	
	M 12 S (PR-2B)	Z8	574736	
	M 15 S (PR-2B)	Z8	574738	
	M 18 S (PR-2B)	Z8	574740	
	M 22 S (PR-2B)	Z8	574742	
	M 28 S (PR-2B)	Z8	574744	
	M 35 S (PR-2B)	Z8	574746	
	Seppelfricke VSH SudoPress C-Stahl Visu-Control	V 12		570107
		V 15		570115
		V 18		570125
		V 22		570135
		V 28		570145
		V 35		570155
		V 42		570165
V 54			570175	
V 12 S (PR-2B)		Z8	574748	
V 15 S (PR-2B)		Z8	574752	
V 18 S (PR-2B)		Z8	574756	
V 22 S (PR-2B)		Z8	574758	
V 28 S (PR-2B)		Z8	574760	
V 35 S (PR-2B)		Z8	574762	
Seppelfricke VSH SudoPress Edelstahl Visu-Control		V 12		570107
	V 15		570115	
	V 18		570125	
	V 22		570135	
	V 28		570145	
	V 35		570155	
	V 42		570165	
	V 54		570175	
	V 12 S (PR-2B)	Z8	574748	
	V 15 S (PR-2B)	Z8	574752	
	V 18 S (PR-2B)	Z8	574756	
	V 22 S (PR-2B)	Z8	574758	
	V 28 S (PR-2B)	Z8	574760	
	V 35 S (PR-2B)	Z8	574762	
	Seppelfricke VSH SudoPress Kupfer Visu-Control	V 12		570107
V 15			570115	
V 18			570125	
V 22			570135	
V 28			570145	
V 35			570155	
V 42			570165	
V 54			570175	
V 12 S (PR-2B)		Z8	574748	
V 15 S (PR-2B)		Z8	574752	
V 18 S (PR-2B)		Z8	574756	
V 22 S (PR-2B)		Z8	574758	
V 28 S (PR-2B)		Z8	574760	
V 35 S (PR-2B)		Z8	574762	
Seppelfricke VSH SudoPress Kupfer Gas Visu-Control		V 12		570107
	V 15		570115	
	V 18		570125	
	V 22		570135	
	V 28		570145	
	V 35		570155	
	V 42		570165	
	V 54		570175	
	V 12 S (PR-2B)	Z8	574748	
	V 15 S (PR-2B)	Z8	574752	
Seppelfricke VSH XPress C-Stahl	M 12		570100	
	M 15		570110	
	M 18 ¹⁾		570120	
	M 22		570130	
	M 28 ¹⁾		570140	
	M 35		570150	
Seppelfricke VSH XPress C-Stahl	M 42 (PZ-4G)		570160	
	M 54 (PZ-4G)		570170	
	M 42 (PR-3S)	Z2	572706	
	M 54 (PR-3S)	Z2	572708	
	M 76,1 XL (PR-3S)	Z6 XL ³⁾ / Z7 XL 45 kN ⁴⁾	579101	
	M 12 S (PR-2B)	Z8	574736	
	M 15 S (PR-2B)	Z8	574738	
	M 18 S (PR-2B)	Z8	574740	
	M 22 S (PR-2B)	Z8	574742	
	M 28 S (PR-2B)	Z8	574744	
	M 35 S (PR-2B)	Z8	574746	

REMS pressing tongs REMS pressing rings

Accessories for REMS radial presses (except for REMS Mini-Press) and suitable radial presses of other makes

System	Pressing tongs / pressing rings	Driven by adapter tongs	Art.-No.
Seppelfricke VSH XPress Edelstahl	M 15		570110
	M 18 ⁹⁾		570120
	M 22		570130
	M 28 ⁹⁾		570140
	M 35		570150
	M 42 (PZ-4G)		570160
	M 54 (PZ-4G)		570170
	M 42 (PR-3S)	Z2	572706
	M 54 (PR-3S)	Z2	572708
	M 76,1 XL (PR-3S)	Z6 XL ³⁾ / Z7 XL 45 kN ⁴⁾	579101
	M 15 S (PR-2B)	Z8	574738
	M 18 S (PR-2B)	Z8	574740
	M 22 S (PR-2B)	Z8	574742
M 28 S (PR-2B)	Z8	574744	
M 35 S (PR-2B)	Z8	574746	
Seppelfricke VSH XPress Edelstahl Gas	M 15		570110
	M 18 ⁹⁾		570120
	M 22		570130
	M 28 ⁹⁾		570140
	M 35		570150
	M 42 (PR-3S)	Z2	572706
	M 54 (PR-3S)	Z2	572708
Seppelfricke VSH XPress Kupfer	M 12		570100
	M 15		570110
	M 18 ⁹⁾		570120
	M 22		570130
	M 28 ⁹⁾		570140
	M 35		570150
	M 42 (PR-3S)	Z2	572706
	M 54 (PR-3S)	Z2	572708
	XP 64,0 XL (PR-3S)	Z6 XL ³⁾ / Z7 XL 45 kN ⁴⁾	579100
	XP 66,7 XL (PR-3S)	Z6 XL ³⁾ / Z7 XL 45 kN ⁴⁾	579108
	M 76,1 XL (PR-3S)	Z6 XL ³⁾ / Z7 XL 45 kN ⁴⁾	579101
	XP 108,0 XL (PR-3S)	Z6 XL ³⁾ / Z7 XL 45 kN ⁴⁾	579109
	M 12 S (PR-2B)	Z8	574736
	M 15 S (PR-2B)	Z8	574738
	M 18 S (PR-2B)	Z8	574740
M 22 S (PR-2B)	Z8	574742	
M 28 S (PR-2B)	Z8	574744	
M 35 S (PR-2B)	Z8	574746	
Seppelfricke VSH XPress Kupfer Gas	M 15		570110
	M 18 ⁹⁾		570120
	M 22		570130
	M 28 ⁹⁾		570140
	M 35		570150
	M 42 (PR-3S)	Z2	572706
M 54 (PR-3S)	Z2	572708	
SESTA SESTA GAS	TH 14*		570455
	TH 16*		570460
	TH 20*		570470
	TH 26*		570475
	TH 32		570480
SESTA Sistema multistrato	H 16*		570320
	H 20*		570350
	TH 14*		570455
	TH 16*		570460
	TH 18*		570465
	TH 20*		570470
	TH 26*		570475
	TH 32		570480
	TH 40		570485
	TH 50 (PZ-S)		572400
	TH 63 (PZ-S)		572405
	U 16*		570765
	U 20*		570775
SIGMA LI Premium	TH 16*		570460
	TH 20*		570470
	TH 25*		570495
	TH 32		570480
	TH 16 S (PR-2B)	Z8	574782
	TH 20 S (PR-2B)	Z8	574788
	TH 32 S (PR-2B)	Z8	574798
	U 16*		570765
	U 20*		570775
	U 25*		570780
	U 32		570785

System	Pressing tongs / pressing rings	Driven by adapter tongs	Art.-No.	
SLOVARM PEX-THERM	U 16*		570765	
	U 20*		570775	
	H 26*		570370	
	U 32		570785	
	H 16*		570320	
	H 20*		570350	
	H 26*		570370	
	H 32		570380	
	STANDARD HIDRAULICA MultiStandard	H 16*		570320
		H 20*		570350
H 25*			570360	
H 32			570380	
RFz 16*			571325	
RFz 20*			571330	
RFz 25			571335	
RFz 32			571340	
TH 16*			570460	
TH 20*			570470	
TH 25*		570495		
TH 32		570480		
TH 16 S (PR-2B)	Z8	574782		
TH 20 S (PR-2B)	Z8	574788		
TH 32 S (PR-2B)	Z8	574798		
U 16*		570765		
U 18*		570770		
U 20*		570775		
U 25*		570780		
U 32		570785		
U 40		570790		
U 50		570795		
U 63 (PR-3B)	Z4	572837		
U 63 (PZ-S)		572365		
steeltrade Presssystem Edelstahl Kontur M	M 15		570110	
	M 18 ⁹⁾		570120	
	M 22		570130	
	M 28 ⁹⁾		570140	
	M 35		570150	
	M 42 (PR-3S)	Z2	572706	
	M 54 (PR-3S)	Z2	572708	
	M 76,1 XL (PR-3S)	Z6 XL ³⁾ / Z7 XL 45 kN ⁴⁾	579101	
	M 88,9 G XL (PR-3S)	Z6 XL ³⁾ / Z7 XL 45 kN ⁴⁾	579110	
	M 108,0 G XL (PR-3S)	Z6 XL ³⁾ / Z7 XL 45 kN ⁴⁾	579111	
M 15 S (PR-2B)	Z8	574738		
M 18 S (PR-2B)	Z8	574740		
M 22 S (PR-2B)	Z8	574742		
M 28 S (PR-2B)	Z8	574744		
M 35 S (PR-2B)	Z8	574746		
STELBI Polikraft	H 16*		570320	
	H 20*		570350	
	H 26*		570370	
	TH 16*		570460	
	TH 20*		570470	
	TH 26*		570475	
	TH 32		570480	
	TH 40		570485	
	TH 50 (PZ-S)		572400	
	TH 63 (PZ-S)		572405	
TH 16 S (PR-2B)	Z8	574782		
TH 20 S (PR-2B)	Z8	574788		
TH 26 S (PR-2B)	Z8	574794		
TH 32 S (PR-2B)	Z8	574798		
U 16*		570765		
U 20*		570775		
STELBI Stelgas	TH 16*		570460	
	TH 20*		570470	
	TH 26*		570475	
	TH 16 S (PR-2B)	Z8	574782	
	TH 20 S (PR-2B)	Z8	574788	
TH 26 S (PR-2B)	Z8	574794		

Pressfitting systems for gas installations must only be pressed with pressing tongs/pressing rings which are highlighted in yellow.

Observe the national regulations. Read and observe the instructions for use and the installation instructions of the system provider/manufacturer.

* These pressing tongs also fit the manual radial press REMS Eco-Press. Observe the national regulations.

¹⁾ Only pressing tongs from designation "108" (1st quarter of 2008), "208" (2nd quarter of 2008) etc. can be used. The designation is stamped on every pressing jaw.

²⁾ For this pressfitting system producing a pressing joint with manual radial presses is not permitted.

³⁾ Driven by REMS Power-Press XL ACC.

⁴⁾ Driven by REMS Akku-Press XL 45 kN 22 V ACC.

⁵⁾ For taking suitable pressing inserts.

⁶⁾ Press fittings made of red bronze (Sanpress XL) must be pressed with pressing rings with press contour VR, copper fittings (Profipress XL, Profipress G XL), carbon steel (Prestabo XL) and stainless steel fittings (Sanpress Inox XL, Sanpress Inox G XL) with pressing rings with press contour VF.

⁷⁾ Use pressing rings labelled "M 88.9 G" or "M 108 G" on the three pressing segments for gas installations.

⁸⁾ For making press joints for operating pressure \leq PN 10.

⁹⁾ For pipes of the EN technical standard. Observe the instructions for use of the system provider/manufacturer.

¹⁰⁾ For pipes of the ASTM technical standard. Observe the instructions for use of the system provider/manufacturer.

The suitability of REMS pressing tools for pressfitting systems: Date 12.10.2022. For the updated situation regarding suitability status check our website:

www.rems.de > Downloads > Product catalogues, brochures > REMS Catalogue.

See page 236 for adapter tongs. Pressing tongs/pressing rings for additional pressfitting systems on request.

REMS pressing tongs

REMS pressing rings

Accessories for REMS radial presses (except for REMS Mini-Press) and suitable radial presses of other makes

System	Pressing tongs / pressing rings	Driven by adapter tongs	Art.-No.
STH Westco COPPER PRESS	M 15		570110
	M 22		570130
	M 28 ¹⁾		570140
	M 35		570150
	M 42 (PR-3S)	Z2	572706
	M 54 (PR-3S)	Z2	572708
	M 15 S (PR-2B)	Z8	574738
	M 22 S (PR-2B)	Z8	574742
	M 28 S (PR-2B)	Z8	574744
	M 35 S (PR-2B)	Z8	574746

T

TDM BRASS Serie 1600	H 16*		570320
	H 18*		570340
	H 20*		570350
	H 25*		570360
	H 26*		570370
	H 32		570380
	TH 16*		570460
	TH 18*		570465
	TH 20*		570470
	TH 25*		570495
	TH 26*		570475
	THL 32		570487
	TH 40		570485
	TH 50 (PZ-S)		572400
	TH 63 (PZ-S)		572405
	TH 16 S (PR-2B)	Z8	574782
	TH 20 S (PR-2B)	Z8	574788
	TH 26 S (PR-2B)	Z8	574794
	U 16*		570765
	U 18*		570770
U 20*		570775	
U 25*		570780	
C 26*		570750	
U 32		570785	

TDM BRASS Serie 2600	H 16*		570320
	H 18*		570340
	H 20*		570350
	H 25*		570360
	H 26*		570370
	H 32		570380
	TH 16*		570460
	TH 18*		570465
	TH 20*		570470
	TH 25*		570495
	TH 26*		570475
	THL 32		570487
	TH 50 (PZ-S)		572400
	TH 63 (PZ-S)		572405
	TH 16 S (PR-2B)	Z8	574782
	TH 20 S (PR-2B)	Z8	574788
	TH 26 S (PR-2B)	Z8	574794
	U 16*		570765
	U 18*		570770
	U 20*		570775
U 25*		570780	
C 26*		570750	
U 32		570785	

TDM BRASS Serie 1700 gas	TH 16*		570460
	TH 20*		570470
	TH 26*		570475
	THL 32		570487
	TH 16 S (PR-2B)	Z8	574782
TH 20 S (PR-2B)	Z8	574788	
TH 26 S (PR-2B)	Z8	574794	

TermoConcept TC-PRESS	Basic E01 ³⁾		571855
--------------------------	-------------------------	--	--------

THERMOLUTZ	H 14*		570310
	H 16*		570320
	TH 20*		570470
	TH 20 S (PR-2B)	Z8	574788

TE-SA TE-SA press serie 800	TH 14*		570455
	TH 16*		570460
	TH 18*		570465
	TH 20*		570470
	TH 26*		570475
	TH 32		570480
	TH 40		570485
	TH 50 (PZ-S)		572400
	TH 63 (PZ-S)		572405
	TH 16 S (PR-2B)	Z8	574782
	TH 20 S (PR-2B)	Z8	574788
	TH 26 S (PR-2B)	Z8	574794
	TH 32 S (PR-2B)	Z8	574798

THERMACOME ACOPEX ALU	H 16*		570320
	H 20*		570350
	H 26*		570370
	H 32		570380
	TH 16*		570460
	TH 20*		570470
	TH 26*		570475
	TH 32		570480
	U 16*		570765
	U 20*		570775
U 32		570785	

System	Pressing tongs / pressing rings	Driven by adapter tongs	Art.-No.
TIEMME AL-COBRAPEX Serie 1650	TH 14*		570455
	TH 16*		570460
	TH 18*		570465
	TH 20*		570470
	TH 25*		570495
	TH 26*		570475
	THL 32		570487
	TH 40		570485
	TH 50 (PZ-S)		572400
	TH 63 (PZ-S)		572405
	THz 75 (PR-3B)	Z4	572829
	TH 16 S (PR-2B)	Z8	574782
	TH 20 S (PR-2B)	Z8	574788
TH 26 S (PR-2B)	Z8	574794	

TIEMME Serie 1700 PE-X a pressare	RFz 12*		571320
	RFz 16*		571325
	RFz 20*		571330
	RFz 25		571335
	RFz 32		571340

TIEMME TIEMME Gas	TH 16*		570460
	TH 20*		570470
	TH 26*		570475
	THL 32		570487
	TH 16 S (PR-2B)	Z8	574782
	TH 20 S (PR-2B)	Z8	574788
TH 26 S (PR-2B)	Z8	574794	

TIGRE ALPEX GÁS	TH 16*		570460
	TH 20*		570470
	TH 26*		570475
	TH 32		570480

TKM Systemtechnik	TH 14*		570455
	TH 16*		570460
	TH 20*		570470
	TH 26*		570475
	TH 32		570480
	TH 40		570485
	TH 50 (PZ-S)		572400
	TH 63 (PZ-S)		572405

TRA MULTITRAPRESS	U 16*		570765
	U 18*		570770
	U 20*		570775
	U 25*		570780
	U 32		570785
	U 40		570790
	U 50		570795
	U 63 (PR-3B)	Z4	572837
	U 63 (PZ-S)		572365

TRA TRAPRESS	H 12*		570300
	H 16*		570320
	H 20*		570350
	H 25*		570360
	H 32		570380
	RFz 12*		571320
	RFz 16*		571325
	RFz 20*		571330
	RFz 25		571335
	RFz 32		571340

Tradelink TradePex Crimp Water	K16/P18*		572600
	K/20*		572605
	K/25*		572610
	K32		572615
	K1/40		572620
K1/50		572625	

Tradelink TradePex Crimp Gas	K16/P18*		572600
	K/20*		572605
	K/25*		572610
	K32		572615
	K1/40		572620
	K1/50		572625

TUBIPLAST ITALY MULTILAYER PIPE	TH 16*		570460
	TH 18*		570465
	TH 20*		570470
	TH 26*		570475
	TH 32		570480
	TH 40		570485
	TH 50 (PZ-S)		572400
	TH 63 (PZ-S)		572405
	TH 16 S (PR-2B)	Z8	574782
	TH 20 S (PR-2B)	Z8	574788
	TH 26 S (PR-2B)	Z8	574794
	TH 32 S (PR-2B)	Z8	574798
	H 16*		570320
	H 18*		570340

TUBIPLAST ITALY MULTILAYER PIPE	H 20*		570350
	H 26*		570370
	H 32		570380
	U 16*		570765
	U 18*		570770
	U 20*		570775
	C 26*		570750
	U 32		570785

REMS pressing tongs REMS pressing rings

Accessories for REMS radial presses (except for REMS Mini-Press) and suitable radial presses of other makes

System	Pressing tongs/ pressing rings	Driven by adapter tongs	Art.-No.
TUBIPLAST ITALY MULTILAYER PIPE GAS SYSTEM	TH 16*		570460
	TH 18*		570465
	TH 20*		570470
	TH 26*		570475
	TH 32		570480
	TH 16 S (PR-2B)	Z8	574782
	TH 20 S (PR-2B)	Z8	574788
	TH 26 S (PR-2B)	Z8	574794
TH 32 S (PR-2B)	Z8	574798	
TWEETOP	U 16*		570765
	U 20*		570775
	U 25*		570780
	U 32		570785
	U 40		570790
	U 50		570795
	U 63 (PR-3B)	Z4	572837
	U 63 (PZ-S)		572365
U 75 (PR-3B)	Z4	572828	
U			
UNICAL AG MAX-MULTIPEX	U 16*		570765
	U 20*		570775
	H 26*		570370
	C 26*		570750
	U 32		570785
UNIDELTA DELTAPRESS	TH 16*		570460
	TH 20*		570470
	TH 26*		570475
	TH 32		570480
	TH 40		570485
	TH 50 (PZ-S)		572400
	TH 63 (PZ-S)		572405
	TH 16 S (PR-2B)	Z8	574782
	TH 20 S (PR-2B)	Z8	574788
	TH 26 S (PR-2B)	Z8	574794
	TH 32 S (PR-2B)	Z8	574798
	H 16*		570320
	H 20*		570350
	H 26*		570370
	H 32		570380
	H 40 (PZ-4G)		570390
	U 16*		570765
U 20*		570775	
U 32		570785	
U 40		570790	
U 50		570795	
U 63 (PZ-S)		572365	
UNIDELTA DELTAPRESS GAS	TH 16*		570460
	TH 20*		570470
	TH 26*		570475
	TH 32		570480
	TH 16 S (PR-2B)	Z8	574782
	TH 20 S (PR-2B)	Z8	574788
	TH 26 S (PR-2B)	Z8	574794
	TH 32 S (PR-2B)	Z8	574798
	H 16*		570320
	H 20*		570350
	H 26*		570370
	H 32		570380
	U 16*		570765
U 20*		570775	
U 32		570785	
Uponor MLC	UP 14*		572630
	UP 16*		572632
	UP 18*		572634
	UP 20*		572636
	UP 25		572638
	UP 32		572640
	U 40		570790
	U 50		570795
	U 63 (PR-3B)	Z4	572837
	U 63 (PZ-S)		572365
	U 75 (PR-3B)	Z4	572828

System	Pressing tongs/ pressing rings	Driven by adapter tongs	Art.-No.
Uponor MLC-D	UP 16*		572632
	UP 20*		572636
	UP 25		572638
	UP 32		572640
	U 50		570795
	U 63 (PR-3B)	Z4	572837
	U 63 (PZ-S)		572365
U 75 (PR-3B)	Z4	572828	
Uponor MLC-G ³⁾	UP 20 ²⁾		572636
	UP 25		572638
	UP 32		572640
Uponor S-Press PLUS	UP 16*		572632
	UP 20*		572636
	UP 25		572638
UP 32		572640	
Uponor Uni Pipe PLUS	UP 16*		572632
	UP 20*		572636
	UP 25		572638
	UP 32		572640
V			
Valsir Bravopress	B 16*		570850
	B 20*		570860
	B 26		570870
	B 32		570880
	F 16*		570717
	F 20*		570727
	F 26*		570730
	F 16 S (PR-2B)	Z8	574728
	F 20 S (PR-2B)	Z8	574730
	F 26 S (PR-2B)	Z8	574732
	H 16*		570320
	H 20*		570350
	H 26*		570370
	H 32		570380
	H 32 V		570685
	TH 16*		570460
	TH 20*		570470
	TH 26*		570475
	TH 32		570480
	U 16*		570765
U 20*		570775	
C 26*		570750	
U 32		570785	
Valsir PEXAL	H 14*		570310
	H 16*		570320
	H 20*		570350
	H 26*		570370
	H 32		570380
	H 32 V		570685
	TH 16*		570460
	TH 20*		570470
	TH 26*		570475
	TH 32		570480
	TH 40		570485
	TH 50 (PZ-S)		572400
	TH 63 (PZ-S)		572405
	U 16*		570765
	U 20*		570775
	C 26*		570750
	U 32		570785
U 40		570790	
U 50		570795	
U 63 (PR-3B)	Z4	572837	
U 63 (PZ-S)		572365	
U 75 (PR-3B)	Z4	572828	

Pressfitting systems for gas installations must only be pressed with pressing tongs/pressing rings which are highlighted in yellow.

Observe the national regulations. Read and observe the instructions for use and the installation instructions of the system provider/manufacturer.

* These pressing tongs also fit the manual radial press REMS Eco-Press. Observe the national regulations.

- 1) Only pressing tongs from designation "108" (1st quarter of 2008), "208" (2nd quarter of 2008) etc. can be used. The designation is stamped on every pressing jaw.
- 2) For this pressfitting system producing a pressing joint with manual radial presses is not permitted.
- 3) Driven by REMS Power-Press XL ACC.
- 4) Driven by REMS Akku-Press XL 45 kN 22 V ACC.
- 5) For taking suitable pressing inserts.
- 6) Press fittings made of red bronze (Sanpress XL) must be pressed with pressing rings with press contour VR, copper fittings (Profipress XL, Profipress G XL), carbon steel (Prestabo XL) and stainless steel fittings (Sanpress Inox XL, Sanpress Inox G XL) with pressing rings with press contour VF.
- 7) Use pressing rings labelled "M 88.9 G" or "M 108 G" on the three pressing segments for gas installations.
- 8) For making press joints for operating pressure ≤ PN 10.
- 9) For pipes of the EN technical standard. Observe the instructions for use of the system provider/manufacturer.
- 10) For pipes of the ASTM technical standard. Observe the instructions for use of the system provider/manufacturer.

The suitability of REMS pressing tools for pressfitting systems: Date 12.10.2022. For the updated situation regarding suitability status check our website: www.rems.de > Downloads > Product catalogues, brochures > REMS Catalogue.

See page 236 for adapter tongs. Pressing tongs/pressing rings for additional pressfitting systems on request.

REMS pressing tongs

REMS pressing rings

Accessories for REMS radial presses (except for REMS Mini-Press) and suitable radial presses of other makes

System	Pressing tongs / pressing rings	Driven by adapter tongs	Art.-No.	
Van Marcke NV Tubipex	TH 16*		570460	
	TH 17*		570462	
	TH 20*		570470	
	TH 26*		570475	
	TH 32		570480	
	TH 40		570485	
	TH 50 (PZ-S)		572400	
	TH 63 (PZ-S)		572405	
	THz 75 (PR-3B)	Z4	572829	
	TH 16 S (PR-2B)	Z8	574782	
	TH 20 S (PR-2B)	Z8	574788	
	TH 26 S (PR-2B)	Z8	574794	
	TH 32 S (PR-2B)	Z8	574798	
	Van Marcke NV Tubipress	M 12		570100
		M 15		570110
M 18			570120	
M 22			570130	
M 28			570140	
M 35			570150	
M 42 (PZ-4G)			570160	
M 54 (PZ-4G)			570170	
M 42 (PR-3S)		Z2	572706	
M 54 (PR-3S)		Z2	572708	
M 76,1 XL (PR-3S)		Z6 XL ³⁾ / Z7 XL 45 kN ⁴⁾	579101	
M 88,9 G XL (PR-3S)		Z6 XL ³⁾ / Z7 XL 45 kN ⁴⁾	579110	
M 108,0 G XL (PR-3S)		Z6 XL ³⁾ / Z7 XL 45 kN ⁴⁾	579111	
M 12 S (PR-2B)		Z8	574736	
M 15 S (PR-2B)		Z8	574738	
M 18 S (PR-2B)		Z8	574740	
M 22 S (PR-2B)		Z8	574742	
M 28 S (PR-2B)	Z8	574744		
M 35 S (PR-2B)	Z8	574746		
Variotherm System TH	TH 11,6*		570482	
	TH 16*		570460	
	TH 20*		570470	
	TH 16 S (PR-2B)	Z8	574782	
	TH 20 S (PR-2B)	Z8	574788	
VESBO CARBON	M 15		570110	
	M 18		570120	
	M 22		570130	
	M 28		570140	
	M 35		570150	
	M 42 (PR-3S)	Z2	572706	
	M 54 (PR-3S)	Z2	572708	
	M 76,1 XL (PR-3S)	Z6 XL ³⁾ / Z7 XL 45 kN ⁴⁾	579101	
	M 88,9 G XL (PR-3S)	Z6 XL ³⁾ / Z7 XL 45 kN ⁴⁾	579110	
	M 108,0 G XL (PR-3S)	Z6 XL ³⁾ / Z7 XL 45 kN ⁴⁾	579111	
	M 15 S (PR-2B)	Z8	574738	
	M 18 S (PR-2B)	Z8	574740	
	M 22 S (PR-2B)	Z8	574742	
	M 28 S (PR-2B)	Z8	574744	
	M 35 S (PR-2B)	Z8	574746	
VESBO INOX	M 15		570110	
	M 18		570120	
	M 22		570130	
	M 28		570140	
	M 35		570150	
	M 42 (PR-3S)	Z2	572706	
	M 54 (PR-3S)	Z2	572708	
	M 76,1 XL (PR-3S)	Z6 XL ³⁾ / Z7 XL 45 kN ⁴⁾	579101	
	M 88,9 G XL (PR-3S)	Z6 XL ³⁾ / Z7 XL 45 kN ⁴⁾	579110	
	M 108,0 G XL (PR-3S)	Z6 XL ³⁾ / Z7 XL 45 kN ⁴⁾	579111	
	M 15 S (PR-2B)	Z8	574738	
	M 18 S (PR-2B)	Z8	574740	
	M 22 S (PR-2B)	Z8	574742	
	M 28 S (PR-2B)	Z8	574744	
	M 35 S (PR-2B)	Z8	574746	
VESBO MULTIPRESS TH-U	TH 16*		570460	
	TH 20*		570470	
	TH 26*		570475	
	TH 32		570480	
	TH 16 S (PR-2B)	Z8	574782	
	TH 20 S (PR-2B)	Z8	574788	
	TH 26 S (PR-2B)	Z8	574794	
	TH 32 S (PR-2B)	Z8	574798	
	U 16*		570765	
	U 20*		570775	
	C 26*		570750	
	U 32		570785	
	VESBO VPREMIUM	U 16*		570765
		U 20*		570775
		U 25*		570780
U 32			570785	
U 40			570790	
U 50			570795	
Viega Fonterra	U 63 (PZ-S)		572365	
	VX 12*		571630	
	VP 14/15*		570905	
	VP 16/17*		570910	
	VP 20*		570915	
	VP 25 ²⁾		570920	
Viega MegaPress (ASTM) ¹⁰⁾	VMP 3/8" (OD 17,2 mm)		571760	
	VMP 1/2" (OD 21,3 mm)		571762	
	VMPz 3/4" (OD 26,9 mm)		571764	
	VMPz 1" (OD 33,7 mm)		571767	
	VMPz 1 1/4" (PZ-S) (OD 42,4 mm)		572413	
	VMPz 1 1/2" (PR-3B) (OD 48,3 mm)	Z5	572844	
	VMPz 2" (PR-3B) (OD 60,3 mm)	Z5	572845	

System	Pressing tongs / pressing rings	Driven by adapter tongs	Art.-No.
Viega MegaPress 304 FKM (ASTM) ¹⁰⁾	VMP 1/2" (OD 21,3 mm)		571762
	VMPz 3/4" (OD 26,9 mm)		571764
	VMPz 1" (OD 33,7 mm)		571767
	VMPz 1 1/4" (PZ-S) (OD 42,4 mm)		572413
	VMPz 1 1/2" (PR-3B) (OD 48,3 mm)	Z5	572844
	VMPz 2" (PR-3B) (OD 60,3 mm)	Z5	572845
Viega MegaPress 316 (ASTM) ¹⁰⁾	VMP 1/2" (OD 21,3 mm)		571762
	VMPz 3/4" (OD 26,9 mm)		571764
	VMPz 1" (OD 33,7 mm)		571767
	VMPz 1 1/4" (PZ-S) (OD 42,4 mm)		572413
	VMPz 1 1/2" (PR-3B) (OD 48,3 mm)	Z5	572844
	VMPz 2" (PR-3B) (OD 60,3 mm)	Z5	572845
Viega MegaPress 316 FKM (ASTM) ¹⁰⁾	VMP 1/2" (OD 21,3 mm)		571762
	VMPz 3/4" (OD 26,9 mm)		571764
	VMPz 1" (OD 33,7 mm)		571767
	VMPz 1 1/4" (PZ-S) (OD 42,4 mm)		572413
	VMPz 1 1/2" (PR-3B) (OD 48,3 mm)	Z5	572844
	VMPz 2" (PR-3B) (OD 60,3 mm)	Z5	572845
Viega MegaPress CuNi (ASTM) ¹⁰⁾	VMP 1/2" (OD 21,3 mm)		571762
	VMPz 3/4" (OD 26,9 mm)		571764
	VMPz 1" (OD 33,7 mm)		571767
	VMPz 1 1/4" (PZ-S) (OD 42,4 mm)		572413
	VMPz 1 1/2" (PR-3B) (OD 48,3 mm)	Z5	572844
	VMPz 2" (PR-3B) (OD 60,3 mm)	Z5	572845
Viega MegaPress FKM (ASTM) ¹⁰⁾	VMP 1/2" (OD 21,3 mm)		571762
	VMPz 3/4" (OD 26,9 mm)		571764
	VMPz 1" (OD 33,7 mm)		571767
	VMPz 1 1/4" (PZ-S) (OD 42,4 mm)		572413
	VMPz 1 1/2" (PR-3B) (OD 48,3 mm)	Z5	572844
	VMPz 2" (PR-3B) (OD 60,3 mm)	Z5	572845
Viega Megapress (EN) ⁹⁾	VMP 3/8" (OD 17,2 mm)		571760
	VMP 1/2" (OD 21,3 mm)		571762
	VMPz 3/4" (OD 26,9 mm)		571764
	VMPz 1" (OD 33,7 mm)		571767
	VMPz 1 1/4" (PZ-S) (OD 42,4 mm)		572413
	VMPz 1 1/2" (PR-3B) (OD 48,3 mm)	Z5	572844
Viega Megapress S (EN) ⁹⁾	VMPz 2" (PR-3B) (OD 60,3 mm)	Z5	572845
	VMP 3/8" (OD 17,2 mm)		571760
	VMP 1/2" (OD 21,3 mm)		571762
	VMPz 3/4" (OD 26,9 mm)		571764
	VMPz 1" (OD 33,7 mm)		571767
	VMPz 1 1/4" (PZ-S) (OD 42,4 mm)		572413
Viega Megapress S XL (EN) ⁹⁾	VMPz 1 1/2" (PR-3B) (OD 48,3 mm)	Z5	572844
	VMPz 2" (PR-3B) (OD 60,3 mm)	Z5	572845
	VMPz 2 1/2" XL (PR-3B) EN (OD 76,1 mm)	Z7 XL 45 kN ⁴⁾	579112
	VMPz 3" XL (PR-3B) (OD 88,9 mm)	Z7 XL 45 kN ⁴⁾	579113
	VMPz 4" XL (PR-3B) (OD 114,3 mm)	Z7 XL 45 kN ⁴⁾	579114
	Viega Pexfit	VX 16*	
VX 20*			571640
VX 25*			571645
Viega Pexfit Fosta G	VX 16*		571635
	VX 20*		571640
	VX 25*		571645
Viega Prestabo	V 12		570107
	V 15		570115
	V 18		570125
	V 22		570135
	V 28		570145
	V 35		570155
	V 42		570165
	V 42 (PR-2B)	Z2	572850
	V 54		570175
	V 54 (PR-2B)	Z2	572851
	Vfz 64,0 (PR-3B) ⁴⁾	Z5	572815
	Vfz 76,1 (PR-3B) ⁴⁾	Z5	572816
	Vfz 88,9 (PR-3B) ⁴⁾	Z5	572817
	Vfz 108,0 (PR-3B) ⁴⁾	Z5	572818
	V 12 S (PR-2B)	Z8	574748
V 15 S (PR-2B)	Z8	574752	
V 18 S (PR-2B)	Z8	574756	
V 22 S (PR-2B)	Z8	574758	
V 28 S (PR-2B)	Z8	574760	
V 35 S (PR-2B)	Z8	574762	
Viega Profifress	V 12		570107
	VG 14		570132
	V 15		570115
	VG 16		570137
	V 18		570125
	V 22		570135
	V 28		570145
	V 35		570155
	V 42		570165
	V 42 (PR-2B)	Z2	572850
	V 54		570175
	V 54 (PR-2B)	Z2	572851
	Vfz 64,0 (PR-3B) ⁴⁾	Z5	572815
	Vfz 66,7 (PR-3B)	Z5	572846
	Vfz 76,1 (PR-3B) ⁴⁾	Z5	572816
Vfz 88,9 (PR-3B) ⁴⁾	Z5	572817	
Vfz 108,0 (PR-3B) ⁴⁾	Z5	572818	
V 12 S (PR-2B)	Z8	574748	
VG 14 S (PR-2B)	Z8	574750	
V 15 S (PR-2B)	Z8	574752	
VG 16 S (PR-2B)	Z8	574754	
V 18 S (PR-2B)	Z8	574756	
V 22 S (PR-2B)	Z8	574758	
V 28 S (PR-2B)	Z8	574760	
V 35 S (PR-2B)	Z8	574762	

REMS pressing tongs REMS pressing rings

Accessories for REMS radial presses (except for REMS Mini-Press) and suitable radial presses of other makes

System	Pressing tongs / pressing rings	Driven by adapter tongs	Art.-No.	
Viega Profipress G	V 12		570107	
	V 14		570132	
	V 15		570115	
	V 16		570137	
	V 18		570125	
	V 22		570135	
	V 28		570145	
	V 35		570155	
	V 42		570165	
	V 42 (PR-2B)	Z2	572850	
	V 54		570175	
	V 54 (PR-2B)	Z2	572851	
	Vfz 64,0 (PR-3B) ⁽⁴⁾	Z5	572815	
	V 12 S (PR-2B)	Z8	574748	
	V 14 S (PR-2B)	Z8	574750	
	V 15 S (PR-2B)	Z8	574752	
	V 16 S (PR-2B)	Z8	574754	
	V 18 S (PR-2B)	Z8	574756	
	V 22 S (PR-2B)	Z8	574758	
	V 28 S (PR-2B)	Z8	574760	
	V 35 S (PR-2B)	Z8	574762	
	Viega Profipress S	V 12		570107
		V 15		570115
		V 18		570125
		V 22		570135
V 28			570145	
V 35			570155	
V 12 S (PR-2B)		Z8	574748	
V 15 S (PR-2B)		Z8	574752	
V 18 S (PR-2B)		Z8	574756	
V 22 S (PR-2B)		Z8	574758	
V 28 S (PR-2B)		Z8	574760	
V 35 S (PR-2B)		Z8	574762	
Viega Profipress Therm		V 12		570107
	V 15		570115	
	V 18		570125	
	V 22		570135	
	V 12 S (PR-2B)	Z8	574748	
	V 15 S (PR-2B)	Z8	574752	
	V 18 S (PR-2B)	Z8	574756	
V 22 S (PR-2B)	Z8	574758		
Viega ProPress (ASTM) ⁽¹⁰⁾	VUS 1/2" (OD 15,9 mm)		571770	
	VUS 3/4" (OD 22,2 mm)		571775	
	VUS 1" (OD 28,6 mm)		571780	
	VUS 1 1/4" (OD 34,9 mm)		571785	
	VUS 1 1/2" (OD 41,3 mm)		571790	
	VUS 2" (OD 54,0 mm)		571795	
	VUSFz 2 1/2" (PR-3B) (OD 66,7 mm)	Z5	572819	
VUSFz 3" (PR-3B) (OD 79,4 mm)	Z5	572820		
VUSFz 4" (PR-3B) (OD 104,8 mm)	Z5	572821		
Viega ProPress 304 FKM (ASTM) ⁽¹⁰⁾	VUS 1/2" (OD 15,9 mm)		571770	
	VUS 3/4" (OD 22,2 mm)		571775	
	VUS 1" (OD 28,6 mm)		571780	
	VUS 1 1/4" (OD 34,9 mm)		571785	
	VUS 1 1/2" (OD 41,3 mm)		571790	
	VUS 2" (OD 54,0 mm)		571795	
	VUSFz 2 1/2" (PR-3B) (OD 66,7 mm)	Z5	572819	
VUSFz 3" (PR-3B) (OD 79,4 mm)	Z5	572820		
VUSFz 4" (PR-3B) (OD 104,8 mm)	Z5	572821		
Viega ProPress 316 (ASTM) ⁽¹⁰⁾	VUS 1/2" (OD 15,9 mm)		571770	
	VUS 3/4" (OD 22,2 mm)		571775	
	VUS 1" (OD 28,6 mm)		571780	
	VUS 1 1/4" (OD 34,9 mm)		571785	
	VUS 1 1/2" (OD 41,3 mm)		571790	
	VUS 2" (OD 54,0 mm)		571795	
	VUSFz 2 1/2" (PR-3B) (OD 66,7 mm)	Z5	572819	
VUSFz 3" (PR-3B) (OD 79,4 mm)	Z5	572820		
VUSFz 4" (PR-3B) (OD 104,8 mm)	Z5	572821		
Viega ProPress WATER System AUS	VAU 15 (OD 12,7 mm)		572687	
	VAU 20 (OD 19,1 mm)		572689	
	VAU 25 (OD 25,4 mm)		572691	
	VAU 32 (OD 31,8 mm)		572693	
	VAU 40 (OD 38,1 mm)		572695	
	VAU 50 (OD 50,8 mm)		572697	
	Viega ProPressG GAS System AUS	VAU 15 (OD 12,7 mm)		572687
VAU 20 (OD 19,1 mm)			572689	
VAU 25 (OD 25,4 mm)			572691	
VAU 32 (OD 31,8 mm)			572693	
VAU 40 (OD 38,1 mm)			572695	
VAU 50 (OD 50,8 mm)			572697	

System	Pressing tongs / pressing rings	Driven by adapter tongs	Art.-No.
Viega Raxinox	VRX 16		571750
	VRX 20		571752
Viega Raxofix	VRX 16		571750
	VRX 20		571752
	VRX 25		571754
	VRX 32		571756
	VRX 40		571758
	VRX 50		571760
	VRX 63		571797
Viega Sanfix ⁽²⁾	VP 16/17 ⁽²⁾		570910
	VP 20 ⁽²⁾		570915
	VP 25 ⁽²⁾		570920
	VP 32		570925
	VP 40 (PZ-4G)		570970
	VPz 50 (PZ-S)		572350
VPz 63 (PZ-S)		572355	
Viega Sanfix Fosta ⁽²⁾	VP 16/17 ⁽²⁾		570910
	VP 20 ⁽²⁾		570915
	VP 25 ⁽²⁾		570920
	VP 32		570925
	VP 40 (PZ-4G)		570970
	VPz 50 (PZ-S)		572350
VPz 63 (PZ-S)		572355	
Viega Sanpress	V 12		570107
	V 15		570115
	V 18		570125
	V 22		570135
	V 28		570145
	V 35		570155
	V 42		570165
	V 42 (PR-2B)	Z2	572850
	V 54		570175
	V 54 (PR-2B)	Z2	572851
	VR 76,1 (PR-3B) ⁽⁴⁾	Z5	572822
	VR 88,9 (PR-3B) ⁽⁴⁾	Z5	572823
	VR 108,0 (PR-3B) ⁽⁴⁾	Z5	572824
	V 12 S (PR-2B)	Z8	574748
	V 15 S (PR-2B)	Z8	574752
V 18 S (PR-2B)	Z8	574756	
V 22 S (PR-2B)	Z8	574758	
V 28 S (PR-2B)	Z8	574760	
V 35 S (PR-2B)	Z8	574762	
Viega Sanpress Inox	V 15		570115
	V 18		570125
	V 22		570135
	V 28		570145
	V 35		570155
	V 42		570165
	V 42 (PR-2B)	Z2	572850
	V 54		570175
	V 54 (PR-2B)	Z2	572851
	Vfz 64,0 (PR-3B) ⁽⁴⁾	Z5	572815
	Vfz 76,1 (PR-3B) ⁽⁴⁾	Z5	572816
	Vfz 88,9 (PR-3B) ⁽⁴⁾	Z5	572817
	Vfz 108,0 (PR-3B) ⁽⁴⁾	Z5	572818
	V 15 S (PR-2B)	Z8	574752
	V 18 S (PR-2B)	Z8	574756
V 22 S (PR-2B)	Z8	574758	
V 28 S (PR-2B)	Z8	574760	
V 35 S (PR-2B)	Z8	574762	
Viega Sanpress Inox G	V 15		570115
	V 18		570125
	V 22		570135
	V 28		570145
	V 35		570155
	V 42		570165
	V 42 (PR-2B)	Z2	572850
	V 54		570175
	V 54 (PR-2B)	Z2	572851
	Vfz 64,0 (PR-3B) ⁽⁴⁾	Z5	572815
	Vfz 76,1 (PR-3B) ⁽⁴⁾	Z5	572816
	Vfz 88,9 (PR-3B) ⁽⁴⁾	Z5	572817
	Vfz 108,0 (PR-3B) ⁽⁴⁾	Z5	572818
	V 15 S (PR-2B)	Z8	574752
	V 18 S (PR-2B)	Z8	574756
V 22 S (PR-2B)	Z8	574758	
V 28 S (PR-2B)	Z8	574760	
V 35 S (PR-2B)	Z8	574762	
Viega Smartpress	VX 16*		571635
	VX 20*		571640
	VX 25*		571645

Pressfitting systems for gas installations must only be pressed with pressing tongs/pressing rings which are highlighted in yellow.

Observe the national regulations. Read and observe the instructions for use and the installation instructions of the system provider/manufacturer.

* These pressing tongs also fit the manual radial press REMS Eco-Press. Observe the national regulations.

¹⁾ Only pressing tongs from designation "108" (1st quarter of 2008), "208" (2nd quarter of 2008) etc. can be used. The designation is stamped on every pressing jaw.

²⁾ For this pressfitting system producing a pressing joint with manual radial presses is not permitted.

³⁾ Driven by REMS Power-Press XL ACC.

⁴⁾ Driven by REMS Akku-Press XL 45 kN 22 V ACC.

⁵⁾ For taking suitable pressing inserts.

⁶⁾ Press fittings made of red bronze (Sanpress XL) must be pressed with pressing rings with press contour VR, copper fittings (Profipress XL, Profipress G XL), carbon steel (Prestabo XL) and stainless steel fittings (Sanpress Inox XL, Sanpress Inox G XL) with pressing rings with press contour VF.

⁷⁾ Use pressing rings labelled "M 88.9 G" or "M 108 G" on the three pressing segments for gas installations.

⁸⁾ For making press joints for operating pressure ≤ PN 10.

⁹⁾ For pipes of the EN technical standard. Observe the instructions for use of the system provider/manufacturer.

¹⁰⁾ For pipes of the ASTM technical standard. Observe the instructions for use of the system provider/manufacturer.

The suitability of REMS pressing tools for pressfitting systems: Date 12.10.2022. For the updated situation regarding suitability status check our website:

www.rems.de > Downloads > Product catalogues, brochures > REMS Catalogue.

See page 236 for adapter tongs. Pressing tongs/pressing rings for additional pressfitting systems on request.

REMS pressing tongs

REMS pressing rings

Accessories for REMS radial presses (except for REMS Mini-Press) and suitable radial presses of other makes

System	Pressing tongs / pressing rings	Driven by adapter tongs	Art.-No.	
Viessmann	TH 14*		570455	
	TH 16*		570460	
	TH 20*		570470	
	TH 26*		570475	
	TH 32		570480	
	TH 40		570485	
Vogel & Noot EASYTEC	TH 16*		570460	
	TH 20*		570470	
	TH 26*		570475	
	TH 32		570480	
	TH 40		570485	
	TH 50 (PZ-S)		572400	
	TH 63 (PZ-S)		572405	
	TH 16 S (PR-2B)	Z8	574782	
	TH 20 S (PR-2B)	Z8	574788	
	TH 26 S (PR-2B)	Z8	574794	
VSH MultiPress	U 14*		570760	
	U 16*		570765	
	U 20*		570775	
	U 25*		570780	
	U 32		570785	
	U 40		570790	
	TH 14*		570455	
	TH 16*		570460	
	TH 20*		570470	
	TH 25*		570495	
	TH 32		570480	
	TH 40		570485	
	TH 50 (PZ-S)		572400	
	TH 63 (PZ-S)		572405	
	TH 16 S (PR-2B)	Z8	574782	
	TH 20 S (PR-2B)	Z8	574788	
	TH 26 S (PR-2B)	Z8	574798	
	VSH MultiPress Gas ²⁾	U 16 ²⁾		570765
		U 20 ²⁾		570775
		U 25 ²⁾		570780
		TH 16 ²⁾		570460
TH 20 ²⁾			570470	
TH 16 S (PR-2B)		Z8	574782	
TH 20 S (PR-2B)		Z8	574788	
VSH SudoPress Carbon		V 12		570107
	V 15		570115	
	V 18		570125	
	V 22		570135	
	V 28		570145	
	V 35		570155	
	V 42		570165	
	V 54		570175	
	XP 66,7 XL (PR-3S)	Z6 XL ³⁾ / Z7 XL 45 kN ⁴⁾	579108	
	M 76,1 XL (PR-3S)	Z6 XL ³⁾ / Z7 XL 45 kN ⁴⁾	579101	
	M 88,9 G XL (PR-3S)	Z6 XL ³⁾ / Z7 XL 45 kN ⁴⁾	579110	
	M 108,0 G XL (PR-3S)	Z6 XL ³⁾ / Z7 XL 45 kN ⁴⁾	579111	
	V 12 S (PR-2B)	Z8	574748	
	V 15 S (PR-2B)	Z8	574752	
	V 18 S (PR-2B)	Z8	574756	
	V 22 S (PR-2B)	Z8	574758	
	V 28 S (PR-2B)	Z8	574760	
V 35 S (PR-2B)	Z8	574762		
VSH SudoPress Copper	V 12		570107	
	V 14		570112	
	V 15		570115	
	V 16		570117	
	V 18		570125	
	V 22		570135	
	V 28		570145	
	V 35		570155	
	V 42		570165	
	V 54		570175	
	V 12 S (PR-2B)	Z8	574748	
	V 14 S (PR-2B)	Z8	574800	
	V 15 S (PR-2B)	Z8	574752	
	V 16 S (PR-2B)	Z8	574802	
V 18 S (PR-2B)	Z8	574756		
V 22 S (PR-2B)	Z8	574758		
V 28 S (PR-2B)	Z8	574760		
V 35 S (PR-2B)	Z8	574762		
VSH SudoPress Copper Gas	V 12		570107	
	V 14		570112	
	V 15		570115	
	V 16		570117	
	V 18		570125	
	V 22		570135	
	V 28		570145	
	V 35		570155	
	V 42		570165	
	V 54		570175	
	VSH SudoPress Stainless	V 15		570115
V 18			570125	
V 22			570135	
V 28			570145	
V 35			570155	
V 42			570165	
V 54			570175	
M 76,1 XL (PR-3S)		Z6 XL ³⁾ / Z7 XL 45 kN ⁴⁾	579101	
M 88,9 G XL (PR-3S)		Z6 XL ³⁾ / Z7 XL 45 kN ⁴⁾	579110	
M 108,0 G XL (PR-3S)		Z6 XL ³⁾ / Z7 XL 45 kN ⁴⁾	579111	
V 15 S (PR-2B)		Z8	574752	
V 18 S (PR-2B)		Z8	574756	
V 22 S (PR-2B)		Z8	574758	
V 28 S (PR-2B)	Z8	574760		
V 35 S (PR-2B)	Z8	574762		

System	Pressing tongs / pressing rings	Driven by adapter tongs	Art.-No.
VSH XPress Carbon	M 12		570100
	M 15		570110
	M 18 ¹⁾		570120
	M 22		570130
	M 28 ¹⁾		570140
	M 35		570150
	M 42 (PZ-46)		570160
	M 54 (PZ-46)		570170
	M 42 (PR-3S)	Z2	572706
	M 54 (PR-3S)	Z2	572708
	XP 66,7 XL (PR-3S)	Z6 XL ³⁾ / Z7 XL 45 kN ⁴⁾	579108
	M 76,1 XL (PR-3S)	Z6 XL ³⁾ / Z7 XL 45 kN ⁴⁾	579101
	M 88,9 G XL (PR-3S)	Z6 XL ³⁾ / Z7 XL 45 kN ⁴⁾	579110
	M 108,0 G XL (PR-3S)	Z6 XL ³⁾ / Z7 XL 45 kN ⁴⁾	579111
	M 12 S (PR-2B)	Z8	574736
	M 15 S (PR-2B)	Z8	574738
VSH XPress Copper	M 12		570100
	M 15		570110
	M 18 ¹⁾		570120
	M 22		570130
	M 28 ¹⁾		570140
	M 35		570150
	M 42 (PR-3S)	Z2	572706
	M 54 (PR-3S)	Z2	572708
	XP 64,0 XL (PR-3S)	Z6 XL ³⁾ / Z7 XL 45 kN ⁴⁾	579100
	XP 66,7 XL (PR-3S)	Z6 XL ³⁾ / Z7 XL 45 kN ⁴⁾	579108
	M 76,1 XL (PR-3S)	Z6 XL ³⁾ / Z7 XL 45 kN ⁴⁾	579101
	M 88,9 G XL (PR-3S)	Z6 XL ³⁾ / Z7 XL 45 kN ⁴⁾	579110
	XP 108,0 XL (PR-3S)	Z6 XL ³⁾ / Z7 XL 45 kN ⁴⁾	579109
	M 12 S (PR-2B)	Z8	574736
	M 15 S (PR-2B)	Z8	574738
	M 18 S (PR-2B)	Z8	574740
M 22 S (PR-2B)	Z8	574742	
M 28 S (PR-2B)	Z8	574744	
M 35 S (PR-2B)	Z8	574746	
VSH XPress Copper GAS	M 15		570110
	M 18 ¹⁾		570120
	M 22		570130
	M 28 ¹⁾		570140
	M 35		570150
	M 42 (PR-3S)	Z2	572706
	M 54 (PR-3S)	Z2	572708
	M 15 S (PR-2B)	Z8	574738
	M 18 S (PR-2B)	Z8	574740
	M 22 S (PR-2B)	Z8	574742
	M 28 S (PR-2B)	Z8	574744
M 35 S (PR-2B)	Z8	574746	
VSH XPress Stainless	M 15		570110
	M 18 ¹⁾		570120
	M 22		570130
	M 28 ¹⁾		570140
	M 35		570150
	M 42 (PZ-46)		570160
	M 54 (PZ-46)		570170
	M 42 (PR-3S)	Z2	572706
	M 54 (PR-3S)	Z2	572708
	M 76,1 XL (PR-3S)	Z6 XL ³⁾ / Z7 XL 45 kN ⁴⁾	579101
	M 88,9 G XL (PR-3S)	Z6 XL ³⁾ / Z7 XL 45 kN ⁴⁾	579110
M 108,0 G XL (PR-3S)	Z6 XL ³⁾ / Z7 XL 45 kN ⁴⁾	579111	
M 15 S (PR-2B)	Z8	574738	
M 18 S (PR-2B)	Z8	574740	
M 22 S (PR-2B)	Z8	574742	
M 28 S (PR-2B)	Z8	574744	
M 35 S (PR-2B)	Z8	574746	
VSH XPress Stainless Gas	M 15		570110
	M 18 ¹⁾		570120
	M 22		570130
	M 28 ¹⁾		570140
	M 35		570150
	M 42 (PR-3S)	Z2	572706
	M 54 (PR-3S)	Z2	572708
	M 15 S (PR-2B)	Z8	574738
	M 18 S (PR-2B)	Z8	574740
	M 22 S (PR-2B)	Z8	574742
	M 28 S (PR-2B)	Z8	574744
M 35 S (PR-2B)	Z8	574746	
W			
Watts MTR Art press	TH 16*		570460
	TH 20*		570470
	TH 26*		570475
	TH 32		570480
WATTS RADIANT Watts WaterPEX	US ¾**		571450
	US ½**		571455
	US ¾**		571460
	US 1**		571465
	US 1 ¼"		571470
	US 1 ½"		571475

REMS pressing tongs REMS pressing rings

Accessories for REMS radial presses (except for REMS Mini-Press)
and suitable radial presses of other makes

System	Pressing tongs / pressing rings	Driven by adapter tongs	Art.-No.
WATTS	US ¾"		571450
RADIANT	US ½"		571455
Watts	US ¾"		571460
RadiantPEX	US 1"		571465
	US 1 ¼"		571470
	US 1 ½"		571475
WATTS	U 16 (½")		570765
RADIANT	U 20 (¾")		570775
Watts	U 25 (¾")		570780
RadiantPEX-AL	U 32 (1")		570785
Wavin	U 50		570795
Tigris K1/M1	U 63 (PR-3B)	Z4	572837
	U 63 (PZ-S)		572365
	U 75 (PR-3B)	Z4	572828
Wavin	B 16*		570850
Tigris K5/M5	B 20*		570860
	B 32		570880
	H 16*		570320
	H 20*		570350
	H 25*		570360
	H 32		570380
	H 40 (PZ-4G)		570390
	TH 16*		570460
	TH 20*		570470
	TH 25*		570495
	TH 32		570480
	TH 40		570485
	TH 16 S (PR-2B)	Z8	574782
	TH 20 S (PR-2B)	Z8	574788
	TH 32 S (PR-2B)	Z8	574798
	U 16*		570765
	U 20*		570775
	U 25*		570780
	U 32		570785
	U 40		570790
	UP 16*		572632
	UP 20*		572636
	UP 25		572638
	UP 32		572640
WEECON	M 15		570110
PRESS-C-Stahl	M 18		570120
	M 22		570130
	M 28		570140
	M 35		570150
	M 42 (PZ-4G)		570160
	M 54 (PZ-4G)		570170
	M 42 (PR-3S)	Z2	572706
	M 54 (PR-3S)	Z2	572708
	M 76,1 XL (PR-3S)	Z6 XL ³⁾ / Z7 XL 45 kN ⁴⁾	579101
	M 88,9 G XL (PR-3S)	Z6 XL ³⁾ / Z7 XL 45 kN ⁴⁾	579110
	M 108,0 G XL (PR-3S)	Z6 XL ³⁾ / Z7 XL 45 kN ⁴⁾	579111
	M 15 S (PR-2B)	Z8	574738
	M 18 S (PR-2B)	Z8	574740
	M 22 S (PR-2B)	Z8	574742
	M 28 S (PR-2B)	Z8	574744
	M 35 S (PR-2B)	Z8	574746
WEECON	M 15		570110
PRESS-Edelstahl	M 18		570120
	M 22		570130
	M 28		570140
	M 35		570150
	M 42 (PZ-4G)		570160
	M 54 (PZ-4G)		570170
	M 42 (PR-3S)	Z2	572706
	M 54 (PR-3S)	Z2	572708
	M 76,1 XL (PR-3S)	Z6 XL ³⁾ / Z7 XL 45 kN ⁴⁾	579101
	M 88,9 G XL (PR-3S)	Z6 XL ³⁾ / Z7 XL 45 kN ⁴⁾	579110
	M 108,0 G XL (PR-3S)	Z6 XL ³⁾ / Z7 XL 45 kN ⁴⁾	579111
	M 15 S (PR-2B)	Z8	574738
	M 18 S (PR-2B)	Z8	574740
	M 22 S (PR-2B)	Z8	574742
	M 28 S (PR-2B)	Z8	574744
	M 35 S (PR-2B)	Z8	574746

System	Pressing tongs / pressing rings	Driven by adapter tongs	Art.-No.
WEECON	V 15		570115
PRESSS-Kupfer	V 18		570125
	V 22		570135
	V 28		570145
	V 35		570155
	V 42		570165
	V 42 (PR-2B)	Z2	572850
	V 54		570175
	V 54 (PR-2B)	Z2	572851
	V 15 S (PR-2B)	Z8	574752
	V 18 S (PR-2B)	Z8	574756
	V 22 S (PR-2B)	Z8	574758
	V 28 S (PR-2B)	Z8	574760
	V 35 S (PR-2B)	Z8	574762
WEM	U 16*		570765
WIELAND	TH 14 ²⁾		570455
cuprotherm	TH 16 ²⁾		570460
CTX ²⁾	TH 18 ²⁾		570465
	TH 20 ²⁾		570470
	TH 26 ²⁾		570475
WKS-Press	TH 14*		570455
	TH 16*		570460
	TH 17*		570462
	TH 20*		570470
	TH 26*		570475
	TH 32		570480
	TH 40		570485
WÜRTH	TH 16*		570460
Würth	TH 20*		570470
	TH 26*		570475
	HE 32		571900
	HEz 40		571904
X			
XtraConnect	F 16*		570717
	F 20*		570727
	F 26*		570730
	F 32		570735
	F 16 S (PR-2B)	Z8	574728
	F 20 S (PR-2B)	Z8	574730
	F 26 S (PR-2B)	Z8	574732
	F 32 S (PR-2B)	Z8	574734
	H 16*		570320
	H 20*		570350
	H 26*		570370
	H 32		570380
	TH 16*		570460
	TH 20*		570470
	TH 26*		570475
	TH 32		570480
	TH 16 S (PR-2B)	Z8	574782
	TH 20 S (PR-2B)	Z8	574788
	TH 26 S (PR-2B)	Z8	574794
	TH 32 S (PR-2B)	Z8	574798
	U 16*		570765
	U 20*		570775
(DN 26)	U 25*		570780
	U 32		570785
	VP 16*		570910
	VP 20*		570915
	VP 32		570925
Z			
ZEWO THERM	TH 12*		570452
Zewo Press Premium	TH 16*		570460
	TH 17*		570462
	TH 18*		570465
	TH 20*		570470
	TH 26*		570475
	TH 32		570480
	TH 40		570485
	TH 50 (PZ-S)		572400
	TH 63 (PZ-S)		572405
ZEWO THERM	TH 16*		570460
Zewo Press PPSU	TH 20*		570470
	TH 26*		570475
	TH 32		570480
ZURN	US ¾"		571450
INDUSTRIES	US ½"		571455
ZURN PEX	US ¾"		571460
	US 1"		571465
	US 1 ¼"		571470
	US 1 ½"		571475
	US 2"		571477

Pressfitting systems for gas installations must only be pressed with pressing tongs/pressing rings which are highlighted in yellow.

Observe the national regulations. Read and observe the instructions for use and the installation instructions of the system provider/manufacturer.

* These pressing tongs also fit the manual radial press REMS Eco-Press. Observe the national regulations.

¹⁾ Only pressing tongs from designation "108" (1st quarter of 2008), "208" (2nd quarter of 2008) etc. can be used. The designation is stamped on every pressing jaw.

²⁾ For this pressfitting system producing a pressing joint with manual radial presses is not permitted.

³⁾ Driven by REMS Power-Press XL ACC.

⁴⁾ Driven by REMS Akku-Press XL 45 kN 22 V ACC.

⁵⁾ For taking suitable pressing inserts.

⁶⁾ Press fittings made of red bronze (Sanpress XL) must be pressed with pressing rings with press contour VR, copper fittings (Profipress XL, Profipress G XL), carbon steel (Prestabo XL) and stainless steel fittings (Sanpress Inox XL, Sanpress Inox G XL) with pressing rings with press contour VF.

⁷⁾ Use pressing rings labelled "M 88.9 G" or "M 108 G" on the three pressing segments for gas installations.

⁸⁾ For making press joints for operating pressure ≤ PN 10.

⁹⁾ For pipes of the EN technical standard. Observe the instructions for use of the system provider/manufacturer.

¹⁰⁾ For pipes of the ASTM technical standard. Observe the instructions for use of the system provider/manufacturer.

The suitability of REMS pressing tools for pressfitting systems: Date 12.10.2022. For the updated situation regarding suitability status check our website:

www.rems.de > Downloads > Product catalogues, brochures > REMS Catalogue.

See page 236 for adapter tongs. Pressing tongs/pressing rings for additional pressfitting systems on request.

Accessories

For REMS radial presses (except for REMS Mini-Press) and suitable radial presses of other makes

Description	Art.-No.
Adapter tongs Z8 for driving REMS pressing rings S (PR-2B)	574702
Adapter tongs Z2 for driving REMS pressing rings M 35–54 (PR-3S), V 42–54 (PR-2B), RN 40–50 (PR-3S)	572795
Adapter tongs Z4 for driving REMS pressing rings F 75 (PR-3B), TH 63–75 (PR-3B), U 63–75 (PR-3B), RN 63 (PR-3B)	572801
Adapter tongs Z5 for driving REMS pressing rings VFz/VR 64–108 (PR-3B), VMPz 1½–2" (PR-3B), VUSFz 2½–4" (PR-3B), VAUFz 65–100 (PR-3B)	572802
Adapter tongs Z6 XL for driving REMS pressing rings 64.0–108.0 XL (PR-3S), 2½–4" XL (PR-3S) with REMS Power-Press XL ACC	579120
Adapter tongs Z7 XL 45 kN for driving REMS pressing rings 64.0–108.0 XL (PR-3S), 2½–4" XL (PR-3S), 2½–4" XL (PR-3B) with REMS Akku-Press XL 45 kN 22V ACC	579123
Steel case with insert for 6 pressing tongs (up to Ø 35 mm/1" and pressing tongs U 40, U 50, TH 40, F 40, F 50, G 40, VUS 1½")/cropping tongs and compartment for pipe cutter up to 42 mm	570295
Steel case with insert for 2 pressing tongs (M 42 (PZ-4G), M 54 (PZ-4G), V 42, V 54, H 40 A, VUS 1½", VUS 2")	570290
Steel case with insert for adapter tongs Z2 and pressing rings M 42 (PR-3S) and M 54 (PR-3S) or pressing rings SA 42 (PR-3S) and SA 54 (PR-3S).	572810
Steel case with insert for adapter tongs Z5 and 4 pressing rings VFz 64.0–108.0/VR 76.1–108.0/VUSFz 2½–4" (PR-3B) or for adapter tongs Z5 and 1 pressing tong VMPz 1½ (PZ-S) and 2 pressing rings VMPz 1½–2" (PR-3B)	572809
Steel case with insert for adapter tongs Mini Z8 and adapter tongs Z8 as well as 6 REMS pressing rings S (PR-2B)	574516
L-Boxx system case with inlay for Mini Z8 adapter tongs and Z8 adapter tongs as well as 14 REMS S pressing rings (PR-2B)	574704
L-Boxx system case with inserts for 8 pressing tongs (2B) and 6 pressing rings S (PR-2B)	571136
L-Boxx system case with inserts for 3 different pressing rings VMPz 2½–4" XL (PR-3B)	571137
XL-Boxx system case with inserts for 3 different pressing rings 64.0–108.0 XL (PR-3S) or 2½–4" XL (PR-3S)	579603
Steel case with inserts for adapter tongs Z2 and pressing rings V 42 (PR-2B) and V 54 (PR-2B)	572813



Confirmation of suitability

The suitability of crimping tools is determined basically by the manufacturer of crimping tools. Moreover the suitability of REMS crimping tools has been confirmed by the system manufacturer/supplier himself or approved through independent testing institutes.

Confirmation of suitability through the system manufacturer/supplier

More than 90 % of the manufacturers/suppliers of the pressfitting systems listed herein have tested REMS pressing tongs and confirmed the suitability for their pressfitting system.

Confirmation of suitability through independent testing institutes

The suitability of REMS pressing tongs for additional pressfitting systems have been confirmed through independent technical institutes:

TÜV-Certificates

Exist for Geberit Mepla, Geberit Mapress C-STAHl, Geberit Mapress EDELSTAHL, Geberit Mapress Kupfer, Nussbaum Cupress, Nussbaum Optipress, Uponor Unipipe, Viega-'profipress', Viega-'profipress G', Viega-'sanfix P', Viega-'sanpress', Viega-'Viegatherm P', Wavin Tigris. The TÜV-certificates confirm that REMS crimping tools are suitable for producing perfect and system-conformity pressing joints corresponding to these systems.

Suitability test according to DVGW W 534 (potable water)

Pressing joints produced with REMS pressing tools were tested by the state-operated material testing institute in Darmstadt/Germany or the material testing institute of the Land of North-Rhine-Westphalia, Germany according to DVGW work sheet W 534. These material testing institutes are certified by the DVGW for making these tests. A representative cross-section of press joints of pressfitting systems Geberit Mapress Edelstahl, Raccorderie Metalliche inoxPRES, Raccorderie Metalliche steelPRES, Uponor Unipipe, Viega Megapress, Viega Profipress and Viega Raxofix. was tested. The tests led to the result that all REMS pressing tools are suitable for producing perfect and system conformity pressing joints in accordance with these systems.

Suitability test according to DVGW G 5614/VP 625 or prEN 1254-7 (gas)

Pressing joints made with REMS pressing tools have been tested by the TÜV or by the Land Material Testing Institute Nordrhein-Westfalen or the DVGW Research Institute Karlsruhe according to DVGW Regulations G 5614/VP 625 or by the BSI (UK) according to prEN 1254-7. A representative cross-section of pressing joints of the pressfitting systems Geberit Mapress Edelstahl Gas, Geberit Mapress Kupfer Gas, Henco Gas, IBP >B<press Gas, Kembla KemPress Gas, Pegler Yorkshire X-Press Copper Gas, Raccorderie Metalliche inoxPRES Gas, Uponor MLC-G, Valsir PEXAL Gas, Viega Profipress G, Viega Pexfit G, Viega Sanpress INOX G, Viega PropressG GAS System (AUS) was tested. The tests led to the result that all REMS pressing tools are suitable for producing perfect and system conformity pressing joints in accordance with these systems.



potable water



gas

Hold-Harmless and Indemnification Agreement

REMS is the first system-independent machine and tool manufacturer to sign liability acceptance agreements for pressing tools.

A hold-harmless and indemnification agreement exists with the:

Zentralverband Sanitär Heizung Klima (Central Organization for the Sanitary-, Heating- and Climatization Industries),
Rathausallee 6, D-53757 St. Augustin,
referred to in the following as "ZVSHK",

Bundesindustrieverband Technische Gebäudeausrüstung e.V.,
Hinter Hoben 149, 53129 Bonn,
referred to in the following as "BTGA",

Verband Deutscher Kälte-Klima-Fachbetriebe e. V. (German Association for Coolant & Air-Conditioning Profession Industries),
Kaiser-Friedrich-Straße 7, D-53113 Bonn,
referred to in the following as "VDKF",

Schweizerisch-Liechtensteinischem Gebäudetechnikverband (Swiss-Liechtenstein Technical Building Association),
Auf der Mauer 11, CH-8023 Zürich,
referred to in the following as "suissetec",

The Zentralverband Sanitär Heizung Klima (ZVSHK), the Bundesindustrieverband Technische Gebäudeausrüstung e. V. (BTGA), the Verband Deutscher Kälte-Klima-Fachbetriebe e. V. (VDKF) and the Schweizerisch-Liechtensteinische Gebäudetechnikverband (suissetec) have made liability acceptance agreements in the interests of trade and industry with REMS GmbH & Co KG (REMS) for the radial pressing tools.

- Manual radial press REMS Eco-Press
- Cordless radial press REMS Mini-Press 14V ACC
- Cordless radial press REMS Mini-Press 22V ACC
- Cordless radial press REMS Mini-Press S 22V ACC
- Electric radial press REMS Power-Press SE
- Electro-hydraulic radial press REMS Power-Press
- Electro-hydraulic radial press REMS Power-Press ACC
- Electro-hydraulic radial press REMS Power-Press XL ACC
- Cordless radial press REMS Akku-Press 14V
- Cordless radial press REMS Akku-Press 14V ACC
- Cordless radial press REMS Akku-Press 22V ACC
- Cordless radial press REMS Akku-Press 22V ACC Connected
- Cordless radial press REMS Akku-Press XL 45 kN 22V ACC
- REMS pressing tongs
- REMS pressing rings
- REMS pressing tongs Mini

This makes REMS the first system-independent machine- and tool manufacturer to have concluded a hold-harmless and indemnification agreement for pressing tools. The conclusion of the agreement was effected on the basis of a successful cooperation established on partnership between REMS, the crafts, trades and industry and their organizations.

Eligible for services and performances from this agreement are all independent professional craftsmen, and companies of such, who are enrolled in the register of artisans and craftsmen (referred to in the following as "SHK-Establishments"), in as far as they have been members of the crafts guild of the sanitary- heating- and climatization enterprises competent for their business location at the time the damage event has arisen, and this crafts guild is associated with a regional guild association, which is a member of the ZVSHK.

Entitled to the services from the agreement with the BTGA are all building technology companies (hereinafter referred to as "TGA companies") insofar as they were a member of the Land Industry Association **Technical Building Equipment** responsible at the seat of their company at the time of the damage case and therefore an indirect member of the BTGA or direct member of the BTGA.

Eligible for services and performances from this agreement with the VDKF are all coolant systems companies or professional organisations (referred to as Coolant and Air-Conditioning Profession Industries) who, at the time the damage is caused, are members of the VDKF.

Eligible for services and performances from this agreement are all building systems companies (following TGA companies) who, at the time the damaged is caused, are members of suissetec.

In as far as the radial pressing tools mentioned show a defect with regard to construction, manufacture or material, or if the operator's manuals are faulty, thereby causing damage for the customer of the SHK-establishment, the Coolant and Air-Conditioning Profession Industries, or the TGA-companies, for which the SHK-establishment or the TGA-company is liable, then REMS shall be additionally liable - aside of the statutory prescriptions - for the consequences resulting from leakage, in accordance with the stipulations and provisions of this hold-harmless agreement.

The assumption of liability agreements apply regardless of which pressfitting system is pressed with the suitable REMS pressing tools. The current status regarding suitability of the REMS pressing tools for pressfitting systems can be viewed on the Internet: www.rems.de > Downloads > Product catalogues, brochures > REMS Catalogue.

For more information please contact info@rems.de.

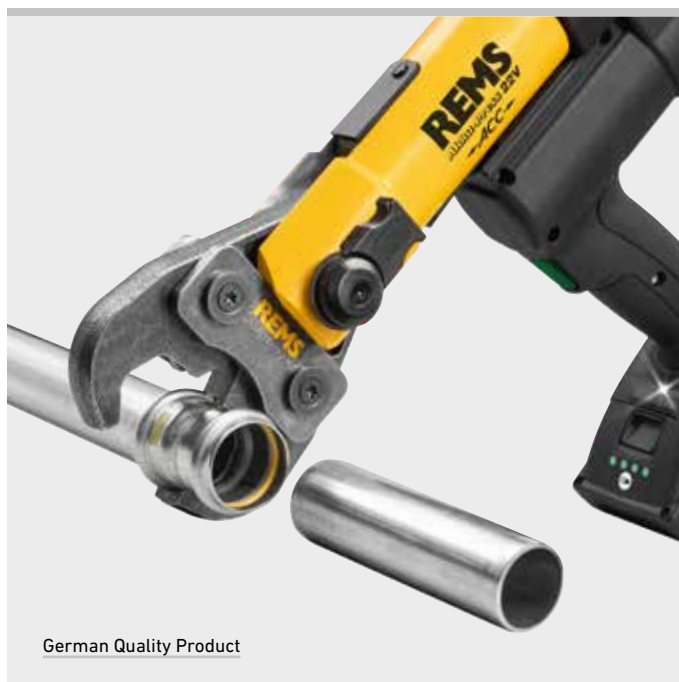

Reliable and safe: REMS was the first system-independent machine and tool manufacturer to sign liability acceptance agreements for pressing tools as early as the year 2000.



REMS cropping tongs

Accessories for REMS radial presses (except for REMS Mini-Press) and suitable radial presses of other makes

High performance cropping tongs in forged and specially hardened steel for cutting threaded rods.

Steel, stainless steel up to hardness classification 4.8 (400 N/mm²) M 6 – M 12

REMS cropping tongs – for cutting threaded rods.

Made of forged and specially hardened steel.

Reversible cropping inserts for double service life.

M cropping inserts with high precision thread contour machined on CNC machining centres for exact guiding of the threaded rod in the cutting process. Pliers parts, cropping inserts and specially machined and hardened cutting edges, made to fit exactly, for cutting without burr.

Threaded rod can be screwed into a threaded connection of the pipe clip or the nut without rework after cutting.

Cutting device in pliers design (**Patent EP 1 459 825, patent US 7,284,330**). Driven by REMS radial presses 32 kN and suitable radial presses of other makes with 32 kN thrust force. All cropping tongs marked with * have an optional connection for manual drive through the radial press REMS Eco-Press.

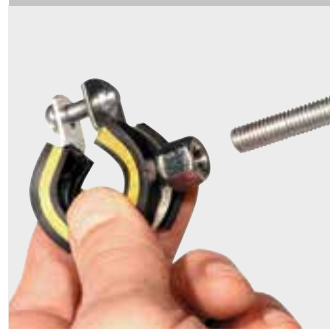
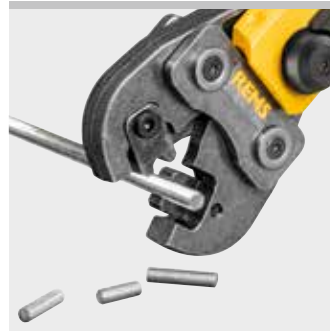

Supply format

REMS cropping tongs. Cropping tongs with 1 pair of reversible cropping inserts for steel, stainless steel, M 6 – M 12. In a carton.

Description	for threaded rods	Art.-No.
REMS cropping tongs M 6*	M 6	571890
REMS cropping tongs M 8*	M 8	571895
REMS cropping tongs M 10	M 10	571865
REMS cropping tongs M 12	M 12	571870

German Quality Product



Patent EP 1 459 825
Patent US 7,284,330

Accessories

Description	for threaded rods	Art.-No.
Cropping inserts M 6 (pair)	M 6	571891
Cropping inserts M 8 (pair)	M 8	571896
Cropping inserts M 10 (pair)	M 10	571866
Cropping inserts M 12 (pair)	M 12	571871
Steel case with insert for 6 cropping tongs/pressing tongs and compartment for pipe cutter up to 42 mm		570295



REMS cable shear

Accessories for REMS radial presses (except for REMS Mini-Press) and suitable radial presses of other makes

High-grade cable shear in forged and specially hardened steel for cutting electric cable.

Electric cable ≤ 300 mm² (Ø 30 mm)

REMS cable shear – Easy cutting of electric cable.

Made of forged and specially hardened steel.

Replaceable cutting blades manufactured on CNC production centres ensure a precision blade geometry and long service life. Large cutting range.

Driven by REMS radial presses 32 kN and suitable radial presses of other makes with 32 kN thrust force.



German Quality Product



Supply format

REMS cable shear. Cable shears with 2 changeable cable cutters for electric cables ≤ 300 mm² (Ø 30 mm). In a carton.

Description	Art.-No.
Cable cutters (pack of 2)	571887



Accessories

Description	Art.-No.
Cable cutters (pack of 2)	571889



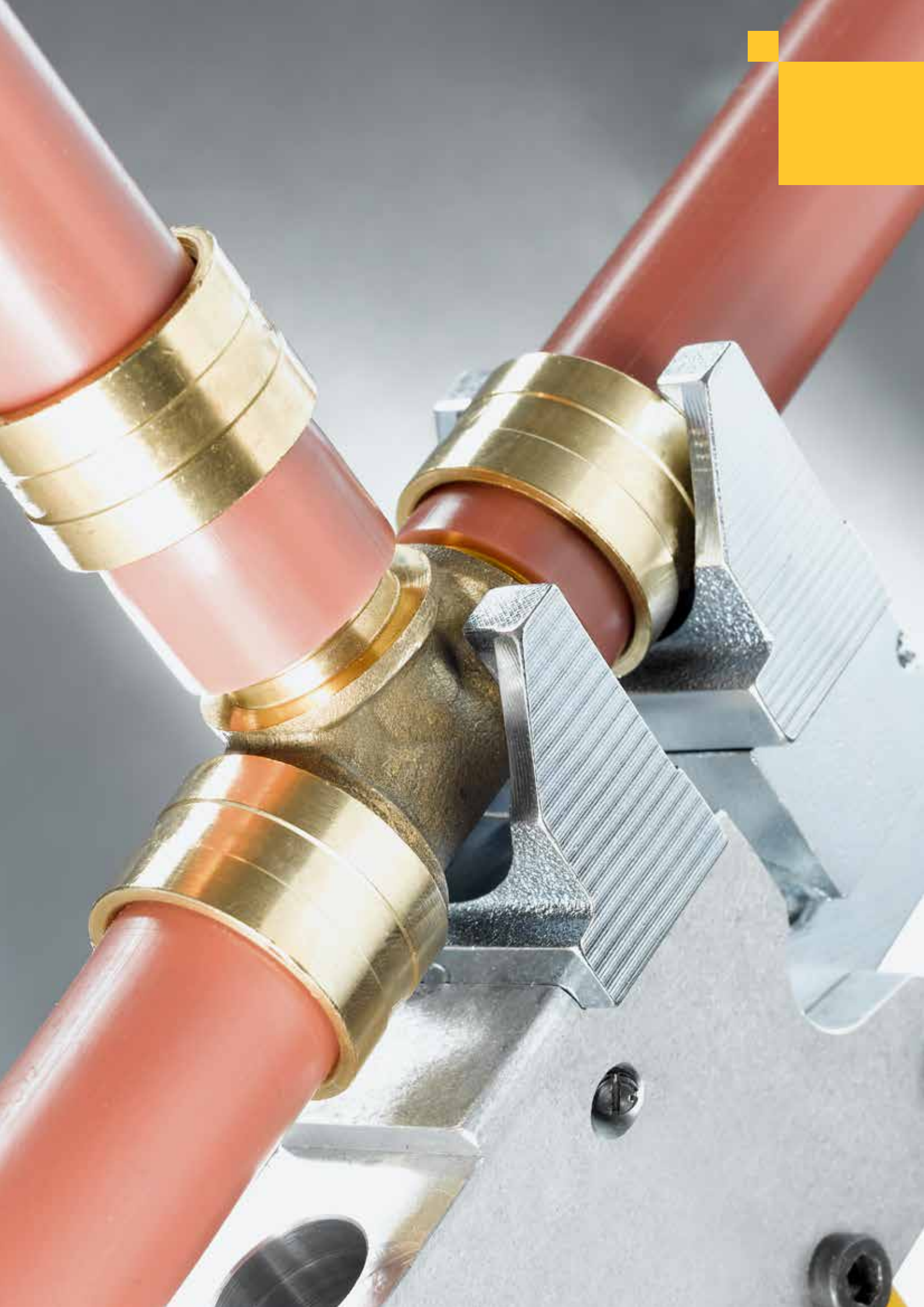

Axial Press Jointing

	Cordless axial press 30 22V Compression heads	242
	Manual axial press	243
	Cordless axial press 25 22V Cordless axial press 25 L 22V	244
	Compression heads	246

REMS Ax-Press 30 22V

Cordless axial press 30 kN

Compact, handy electric tool for producing compression sleeve joints with crimping sleeve. For trade and industry. For the building site and the workshop. Li-Ion 22V Technology. For battery and corded operation.

Axial compression \varnothing 12–32 mm

REMS Ax-Press 30 22V – up to \varnothing 32 mm. Ultra light, ultra small, ultra handy, ultra fast. Li-Ion 21.6 V, 2.5 Ah battery for approx. 220 pressings Georg Fischer pfcI ALUPEX-EXPRESS \varnothing 16 mm with one battery charge*.

Compression heads for all common systems

Complete assortment of REMS compression heads for all common compression sleeve systems with crimping sleeve. High-grade compression heads in forged and specially hardened steel. The REMS compression heads are system-specific and correspond to the respective compression sleeve system. Thus perfect system-conformity, safe jointing.

Design

Compact, handy, light. Drive unit with battery only 4.6 kg. Vertically from the drive unit located pressing device for seating the compression heads. Can be used anywhere, free hand, over head, in confined spaces. Optimum weight distribution for one-hand operation. Drive unit with inserted compression heads can be put down on the battery ready to pick up. Ergonomically designed housing with soft grip. LED work light for illuminating the work place. Compression heads and expander heads quickly interchangeable, without tools. Secure spring lock seating of compression heads.

Drive

High pressing force for perfect pressing in seconds, e.g. \varnothing 26 mm in only 5 s. Thrust force 30 kN. Powerful electro-hydraulic drive, eccentric reciprocating pump with robust planetary gear. Powerful electro-hydraulic drive with powerful battery motor 21.6 V, 380 W output, robust planetary gear, eccentric reciprocating pump and compact high power hydraulic system. Safety tip switch.

Battery or mains operation

Li-Ion 22V Technology. Highly resistant Li-Ion 21.6V battery with 2.5, 4.4, 5.0 or 9.0Ah capacity, for long service life. Light and powerful. Li-Ion 21.6 V, 2.5Ah battery for approx. 220 pressings, 4.4 Ah for approx. 380 pressings, 5.0 Ah for approx. 430 pressings, 9.0Ah for approx. 780 pressings Georg Fischer pfcI ALUPEX-EXPRESS \varnothing 16 mm with one battery charge*. Graduated charging status check by coloured LEDs. Operating temperature range – 10 to + 60°C. No memory effect for maximum battery power. Rapid charger 100–240V, 90W. Rapid charger 100–240V, 290W, for shorter charging times, as accessory. Voltage supply 220–240V/21.6V, 15A output, for mains operation instead of Li-Ion battery 21.6 V, as accessory.

Supply format

REMS Ax-Press 30 22V Basic-Pack. Cordless axial press 30 kN for producing compression sleeve joints with crimping sleeve \varnothing 12–32 mm. Electro-hydraulic drive with powerful battery motor 21.6 V, 380 W, robust planetary gear, eccentric reciprocating pump and compact high power hydraulic system, safety tip switch. LED work light. Battery Li-Ion 21.6 V, 2.5 Ah, rapid charger 220–240V, 50–60Hz, 70W. In sturdy steel case.

	Art.-No.
	573018

Accessories

Description	Art.-No.
REMS Ax-Press 30 22V drive unit, without battery	573008
Battery Li-Ion 21.6V, 2.5 Ah	571571
Battery Li-Ion 21.6V, 4.4 Ah	571574
Battery Li-Ion 21.6V, 5.0 Ah	571581
Battery Li-Ion 21.6V, 9.0 Ah	571583
Rapid charger 100–240V, 50–60Hz, 90W	571585
Rapid charger 100–240V, 50–60Hz, 290W	571587
Voltage supply 220–240V/21.6V, 50–60Hz, 15A, for mains operation instead of battery Li-Ion 21.6 V.	571567
Steel case with insert	573282
REMS Lumen 2800 22V, cordless LED flood light, see page 111	

REMS compression heads

Compression sleeve system	Compression head	Art.-No.
Brasstech Raptor/ Metalpex/ Raptor 2/ MULTitermoSAN	ME 14 (pack of 2)	573100
	ME 16 (pack of 2)	573102
	ME 20 (pack of 2)	573106
	ME 26 (pack of 2)	573108
	ME 32 (pack of 2)	573110
General Fittings Serie 5400	ME 14 (pack of 2)	573100
	ME 16 (pack of 2)	573102
	ME 20 (pack of 2)	573106
	ME 26 (pack of 2)	573108
	ME 32 (pack of 2)	573110



e.g. Brasstech, General Fittings, Georg Fischer pfcI

German Quality Product



Info



REMS compression heads

Compression sleeve system	Compression head	Art.-No.
Georg Fischer pfcI ALUPEX-EXPRESS/ Alupex Gas System	ME 16 (pack of 2)	573102
	ME 20 (pack of 2)	573106
	ME 26 (pack of 2)	573108
Logstor	ME 16 (pack of 2)	573102
	LR 20 (pack of 2)	573430
	LR 22 (pack of 2)	573432
	LR 25 (pack of 2)	573434
	LR 28 (pack of 2)	573436
	LR 32 (pack of 2)	573438

REMS Ax-Press HK / H

One-hand axial press / Manual axial press

Universal manual axial press for producing compression sleeve joints.

Axial compression Ø 12 – 32 mm

REMS Ax-Press HK – universal up to Ø 22 mm
Ultra small, ultra light, ultra handy. Only 1.1 kg

REMS Ax-Press H – universal up to Ø 32 mm.
Handy and light. Only 1.4 kg.

Complete assortment of REMS compression heads, quickly interchangeable.

System advantage

Only **one** type of compression heads for REMS Ax-Press HK, REMS Ax-Press H, REMS Ax-Press 25 22V ACC, REMS Ax-Press 25 L 22V ACC. Thus easy, economic stocking.

Compression heads

Full range of REMS compression heads for all common compression sleeve systems (page 246–247). Choice of REMS compression heads with spring lock for seating common compression inserts. High-grade compression heads in forged and specially hardened steel. The REMS compression heads are system-specific and meet the demands of compression sleeve systems. Thus perfect system-conformity, safe jointing.

Twin compression heads

REMS twin compression heads with two holders each which interleave, for pipe unions of different dimensions (page 246). No need to change compression heads. Extremely simple, saves time.

Design

Compact, job site proven. Handy and light. REMS Ax-Press HK drive unit only 1.1 kg. REMS Ax-Press H drive unit only 1.4 kg. Works anywhere, free-hand, also in tight spots. 66 mm stroke. Quick-acting forward and release for easy, fast operation. Selectable compression head position (**Patent DE 10 2004 018 429, Patent ES 2 273 563, Patent FR 05 03513**) for pressing compression sleeve connectors with a clamping distance of ≤ 161 mm in one action and for double pressings. Quick-change compression heads and pressing inserts without tools. Secure fit of compression heads and pressing inserts by spring catch. REMS Ax-Press H with overload protection.

Expanding

Various pipe expanders and complete range of REMS expanding heads for all common compression sleeve systems (page 251 – 255).

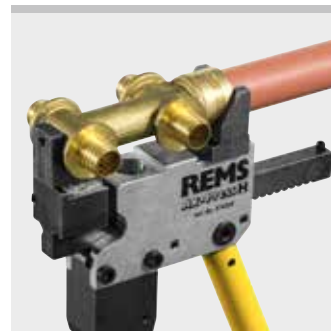

German Quality Product



Supply format

REMS Ax-Press HK drive unit. Axial press for single-handed operation for producing compression sleeve joints Ø 12–22 mm. 66 mm stroke. With quick-acting forward and release. For driving REMS compression heads. In a carton.

	Art.-No.	
	574302	

Supply format

REMS Ax-Press H drive unit. Manual axial press for producing compression sleeve joints Ø 12–32 mm. 66 mm stroke. With quick-acting forward and release. For driving REMS compression heads. In a carton.

	Art.-No.	
	574300	

Accessories

Description	Art.-No.	
REMS compression heads see page 246–247.		
Carrying bag for REMS Ax-Press HK/H drive unit and compression heads	574437	
Case with inlay for REMS Ax-Press HK drive unit and compression heads	574352	



REMS Ax-Press 25 22V ACC
REMS Ax-Press 25 L 22V ACC

Cordless axial press 20 kN with automatic return
 Cordless axial press 13 kN with automatic return

Compact, handy power tool with automatic return for manufacturing compression sleeve joints. Li-Ion 22V Technology. For battery and corded operation. For trade and industry. For the building site and the workshop.

Axial compression \varnothing 12 – 40 mm

REMS Ax-Press 25 22V ACC – universal up to \varnothing 40 mm. Super light, super handy. Fast. With automatic return. Optimum weight distribution for single-hand operation. Swivelling compression device. Li-Ion 21.6 V, 2.5 Ah battery for approx. 500 pressings REHAU RAUTITAN PX \varnothing 16 mm with one battery charge*.

System advantage

Only **one** type of compression heads for REMS Ax-Press HK, REMS Ax-Press H, REMS Ax-Press 25 22V ACC, REMS Ax-Press 25 L 22V ACC. Thus easy, economic stocking.

Compression heads for all common systems

Full range of REMS compression heads for all common compression sleeve systems (page 246 – 247). Choice of REMS compression heads with spring lock for seating common compression inserts. High-grade compression heads in forged and specially hardened steel. The REMS compression heads are system-specific and meet the demands of compression sleeve systems. Thus perfect system-conformity, safe jointing.

Twin compression heads

REMS twin compression heads with two holders each which interleave, for pipe unions of different dimensions (page 246). No need to change compression heads. Extremely simple, saves time.

Design

Compact, handy, light. REMS Ax-Press 25 22V ACC drive machine with battery weighs only 3.0 kg, only 28 cm long REMS Ax-Press 25 L 22V ACC drive machine with battery weighs only 3.2 kg, only 31 cm long REMS Ax-Press 25 22V ACC and REMS Ax-Press 25 L 22V ACC with 40 mm stroke respectively REMS Ax-Press 25 22V ACC with preset compression head position for pressing compression sleeve connectors with a clamping distance $a \leq 82$ mm in one action REMS Ax-Press 25 L 22V ACC with selectable compression head position for pressing compression sleeve connectors with a clamping distance $a \leq 116$ mm in one action and for double pressings. Works anywhere, free-hand, overhead, in confined areas. Optimum weight distribution for single-hand operation. Ergonomically shaped housing with recessed grip. LED work light for illuminating the work place. Swivelling compression device for working in confined area. Compression heads quickly interchangeable, without tools. Secure spring lock seating of compression heads.

Drive

Enormous pressing force for fast and perfect jointing. Thrust force REMS Ax-Press 25 22V 20 kN, thrust force REMS Ax-Press 25 L 22V 13 kN. Powerful electro-hydraulic drive with automatic return (ACC), eccentric reciprocating pump with robust planetary gear. Powerful electro-hydraulic drive with powerful battery motor 21.6 V, 380 W output, robust planetary gear, eccentric reciprocating pump and compact high power hydraulic system. Safety tip switch.

Battery or mains operation

Li-Ion 22V Technology. Highly resistant Li-Ion 21.6V battery with 2.5, 4.4, 5.0 or 9.0 Ah capacity, for long service life. Light and powerful. Li-Ion 21.6 V, 2.5 Ah battery for approx. 500 pressings, 4.4 Ah for approx. 880 pressings, 5.0 Ah for approx. 1000 pressings, 9.0 Ah for approx. 1800 pressings REHAU RAUTITAN PX \varnothing 16 mm with one battery charge*. Graduated charging status check by coloured LEDs. Operating temperature range – 10 to + 60 °C. No memory effect for maximum battery power. Rapid charger 100 – 240V, 90W. Rapid charger 100 – 240V, 290W, for shorter charging times, as accessory. Voltage supply 220 – 240V/21.6 V, 15A output, for mains operation instead of Li-Ion battery 21.6 V, as accessory.

Expanding

Various pipe expanders and complete range of REMS expanding heads for all common pressure sleeve systems

REMS Ax-Press 25 22V ACC



←ACC→
Automatic Circuit Control

with automatic circuit control and charging status check

- e.g.
- aquatherm,
- General Fittings,
- IVT,
- REHAU,
- REVEL,
- Seppelfricke,
- TECE,
- TIEMME,
- Würth



REMS Ax-Press 25 L 22V ACC



←ACC→
Automatic Circuit Control

with automatic circuit control and charging status check

- e.g.
- AC-FIX,
- BARBI,
- FERRO systems
- BRASELI,
- Brass & Fittings,
- EUROP' FLUIDES,
- Fittings Estándar,
- PLÁSTICOS FERRO,
- Velta



German Quality Product

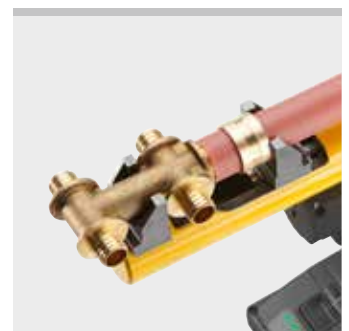

Supply format

REMS Ax-Press 25 22V ACC Basic-Pack. Cordless axial press 20 kN for producing compression sleeve joints Ø 12–40 mm. 40 mm stroke, for pressing compression sleeve connections with a clamping distance $a \leq 82$ mm. For driving REMS pressing heads. Electro-hydraulic drive with powerful battery motor 21.6 V, 380 W, robust planetary gear, eccentric reciprocating pump and compact high power hydraulic system, safety tip switch, swivelling pressing device. LED work light. Battery Li-Ion 21.6 V, 2.5 Ah, rapid charger 220–240V or 110 V, 50–60 Hz, 70 W. Without compression heads. In sturdy steel case.

	Art.-No.	
	573022	

Other voltages on request.

Supply format

REMS Ax-Press 25 L 22V ACC Basic-Pack. Cordless axial press 13 kN for producing compression sleeve joints Ø 12–40 mm. 40 mm stroke, for pressing compression sleeve connections with a clamping distance $a \leq 116$ mm. For driving REMS pressing heads. Electro-hydraulic drive with powerful battery motor 21.6 V, 380 W, robust planetary gear, eccentric reciprocating pump and compact high power hydraulic system, safety tip switch, swivelling pressing device. LED work light. Battery Li-Ion 21.6 V, 2.5 Ah, rapid charger 220–240V or 110 V, 50–60 Hz, 70 W. Without compression heads. In sturdy steel case.

	Art.-No.	
	573023	

Other voltages on request.



Accessories

Description	Art.-No.
REMS compression heads see page 246–247.	
REMS Ax-Press 25 22V ACC drive unit, a ≤ 82 mm, without battery	573020
REMS Ax-Press 25 L 22V ACC drive unit, a ≤ 116 mm, without battery	573021
Battery Li-Ion 21.6 V, 2.5 Ah	571571
Battery Li-Ion 21.6 V, 4.4 Ah	571574
Battery Li-Ion 21.6 V, 5.0 Ah	571581
Battery Li-Ion 21.6 V, 9.0 Ah	571583
Rapid charger 100–240V, 50–60 Hz, 90W	571585
Rapid charger 100–240V, 50–60 Hz, 290W	571587
Voltage supply 220–240V/21.6 V, 50–60 Hz, 15 A, for mains operation instead of battery Li-Ion 21.6 V.	571567
Steel case with insert	578290
REMS Lumen 2800 22V, cordless LED flood light, see page 111	



REMS compression heads

Accessories for REMS Ax-Press HK, REMS Ax-Press H, REMS Ax-Press 25 22V ACC, REMS Ax-Press 25 L 22V ACC



REMS compression heads with spring lock for commercially available press inserts

Description	Use
Compression head Basic 20 (pack of 2)	for pipe fittings 20 mm and for standard press inserts outer Ø 20 mm
Compression head Basic 25 (pack of 2)	for pipe fittings 25 mm and for standard press inserts outer Ø 25 mm
Compression head Basic 32 (pack of 2)	for pipe fittings 32 mm and for standard press inserts outer Ø 32 mm



REMS twin compression heads

Description	Use
Twin compression head RH 16/20 (pack of 2)	for pipe fittings 16 and 20 mm



REMS compression head for T-pieces, elbows, splitters, transition pieces

Description	Use
Compression head UNI T/L (piece)	for T-pieces, elbows, splitters, in combination with an additional compression head; for transition pieces, in combination with a support bolt



REMS support bolt for transition pieces

Description	for transition pieces inch	Art.-No.
Support bolt 3/8"	3/8	573647
Support bolt 1/2"	1/2	573648
Support bolt 3/4"	3/4	573649

Commercially available press inserts:

T's and elbows

Dm 16

Dm 20

Dm 22

Dm 25

Dm 32



REMS compression heads

Accessories for REMS Ax-Press HK, REMS Ax-Press H, REMS Ax-Press 25 22V ACC, REMS Ax-Press 25 L 22V ACC

Select compression heads yourself!

Search for the required compression sleeve system in the table below and select the correct compression heads.

High-grade compression heads in forged and specially hardened steel. Quickly interchangeable, without tools. The REMS compression heads are system-specific and comply with the requirements of the respective compression sleeve system. Thus perfect system-conformity, safe jointing. Drive through REMS axial presses.

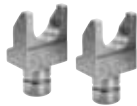

Compr. heads Uni



Compr. head UNI T/L

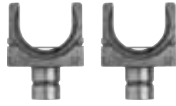

Compr. heads Basic for press inserts

Pressure sleeves system	Compression head mm	Number of pressing heads	fits REMS Ax-Press				Art.-No.
			HK ¹⁾	H	25	25L	
AC-FIX (Global Piping System)	UNI 12	2	•	•	•	•	573630
	UNI 16	2	•	•	•	•	573632
	UNI 20	2	•	•	•	•	573636
	UNI 25	2	•	•	•	•	573640
	UNI 32	2	•	•	•	•	573644
	UNI T/L**	1	•	•	•	•	573646
	Basic 20*	2	•	•	•	•	573624
aquatherm	AT 16	2	•	•	•	•	573120
	AT 20	2	•	•	•	•	573122
	AT 25	2	•	•	•	•	573124
	AT 32	2	•	•	•	•	573126
	AT 40	2	•	•	•	•	573128
	UNI 18	2	•	•	•	•	573634
	UNI 22	2	•	•	•	•	573638
BARBI GLADIATOR (Industrial Blansol)	UNI 20	2	•	•	•	•	573642
	UNI 32	2	•	•	•	•	573644
	UNI 40	2	•	•	•	•	573652
	UNI T/L**	1	•	•	•	•	573646
	Basic 20*	2	•	•	•	•	573624
	Basic 25*	2	•	•	•	•	573616
	Basic 32*	2	•	•	•	•	573628
BARBI RETICULADO (Industrial Blansol)	UNI 12	2	•	•	•	•	573630
	UNI 16	2	•	•	•	•	573632
	UNI 20	2	•	•	•	•	573636
	UNI 25	2	•	•	•	•	573640
	UNI 32	2	•	•	•	•	573644
	UNI 40	2	•	•	•	•	573652
	UNI T/L**	1	•	•	•	•	573646
FERRO systems BRASELI GPF AXIAL	UNI 12	2	•	•	•	•	573630
	UNI 16	2	•	•	•	•	573632
	UNI 20	2	•	•	•	•	573636
	UNI 25	2	•	•	•	•	573640
	UNI 32	2	•	•	•	•	573644
	UNI T/L**	1	•	•	•	•	573646
	Basic 20*	2	•	•	•	•	573624
Brass & Fittings PRESSMAN PowerFit	UNI 16	2	•	•	•	•	573632
	UNI 20	2	•	•	•	•	573636
	UNI 25	2	•	•	•	•	573640
	UNI 32	2	•	•	•	•	573644
	UNI T/L**	1	•	•	•	•	573646
	Basic 20*	2	•	•	•	•	573624
	Basic 25*	2	•	•	•	•	573616
COMAP PEXY	UNI 12	2	•	•	•	•	573630
	UNI 16	2	•	•	•	•	573632
	UNI 20	2	•	•	•	•	573636
	UNI 25	2	•	•	•	•	573640
	UNI 32	2	•	•	•	•	573644
	UNI T/L**	1	•	•	•	•	573646
	Basic 25*	2	•	•	•	•	573616
EUROP FLUIDES HYDROFLUIDES	UNI 12	2	•	•	•	•	573630
	UNI 16	2	•	•	•	•	573632
	UNI 20	2	•	•	•	•	573636
	UNI 25	2	•	•	•	•	573640
	UNI 32	2	•	•	•	•	573644
	UNI T/L**	1	•	•	•	•	573646
	Basic 25*	2	•	•	•	•	573616
Fittings Estándar	UNI 12	2	•	•	•	•	573630
	UNI 16	2	•	•	•	•	573632
	UNI 20	2	•	•	•	•	573636
	UNI 25	2	•	•	•	•	573640
	UNI 32	2	•	•	•	•	573644
	UNI T/L**	1	•	•	•	•	573646
	Basic 20*	2	•	•	•	•	573624
General Fittings Serie 3400 PEX Gold-Fix	RE 16	2	•	•	•	•	573160
	RE 20	2	•	•	•	•	573162
	RE 25	2	•	•	•	•	573172
	RE 32	2	•	•	•	•	573178
	RO 16	2	•	•	•	•	573184
	RO 20	2	•	•	•	•	573186
	General Fittings Serie 3400 PEX/AL/PEX Gold-Fix	RE 16	2	•	•	•	•
RE 20		2	•	•	•	•	573162
RE 25		2	•	•	•	•	573172
RE 32		2	•	•	•	•	573178
RO 16		2	•	•	•	•	573184
RO 20		2	•	•	•	•	573186
General Fittings Serie 3700 PEX		TC 12/14/16	2	•	•	•	•
	TC 18/20	2	•	•	•	•	573364
	TC 25	2	•	•	•	•	573367
	TC 32	2	•	•	•	•	573370
General Fittings Serie 3700 PEX/AL/PEX	TC 12/14/16	2	•	•	•	•	573360
	TC 18/20	2	•	•	•	•	573364
	TC 25	2	•	•	•	•	573367
	TC 32	2	•	•	•	•	573370
HERZ QUICK FIX	HC 16	2	•	•	•	•	573112
	HC 20	2	•	•	•	•	573114
	HC 26	2	•	•	•	•	573116
	HC 32	2	•	•	•	•	573118
IVT PRINETO	IV 16/17	3	•	•	•	•	573320
	IV 20/21	3	•	•	•	•	573325
	IV 25/26	3	•	•	•	•	573330
	IV 32/33	3	•	•	•	•	573335

Pressure sleeves system	Compression head mm	Number of pressing heads	fits REMS Ax-Press				Art.-No.	
			HK ¹⁾	H	25	25L		
PB TUB Sertigliss	UNI 12	2	•	•	•	•	573630	
	UNI 16	2	•	•	•	•	573632	
	UNI 20	2	•	•	•	•	573636	
	UNI 25	2	•	•	•	•	573640	
	UNI 32	2	•	•	•	•	573644	
	UNI T/L**	1	•	•	•	•	573646	
	Basic 25*	2	•	•	•	•	573616	
PLÁSTICOS FERRO FERROPLAST GPF AXIAL	UNI 16	2	•	•	•	•	573632	
	UNI 20	2	•	•	•	•	573636	
	UNI 25	2	•	•	•	•	573640	
	UNI 32	2	•	•	•	•	573644	
	UNI T/L**	1	•	•	•	•	573646	
	Basic 20*	2	•	•	•	•	573624	
	Basic 25*	2	•	•	•	•	573616	
PLUMBING PLUS EZIPEX Sleeve Water (AUS)	RH 16 L	2	•	•	•	•	573150	
	RH 20 L	2	•	•	•	•	573152	
	RH 16/20 L	2	•	•	•	•	573158	
	RH 25	2	•	•	•	•	573154	
	RH 32	2	•	•	•	•	573156	
	Basic 20*	2	•	•	•	•	573152	
	Basic 25*	2	•	•	•	•	573158	
PLUMBING PLUS EZIPEX Sleeve Gas (AUS)	RH 16 L	2	•	•	•	•	573150	
	RH 20 L	2	•	•	•	•	573152	
	RH 16/20 L	2	•	•	•	•	573158	
	RH 25	2	•	•	•	•	573154	
	RH 32	2	•	•	•	•	573156	
	REHAU RAUTHERM SDR 11 LX	RH 12	2	•	•	•	•	573164
	RH 16	2	•	•	•	•	573166	
RH 20	2	•	•	•	•	573170		
RH 25	2	•	•	•	•	573154		
RH 32	2	•	•	•	•	573156		
REHAU RAUTHERM S (REHAU HAS)	RH 17	2	•	•	•	•	573168	
	RH 20	2	•	•	•	•	573170	
	RH 25	2	•	•	•	•	573154	
	RH 32	2	•	•	•	•	573156	
	REHAU RAUTITAN PX/MX/SX/RX/ gas/sprinkler	RE 16	2	•	•	•	•	573160
	RE 20	2	•	•	•	•	573162	
	RE 25	2	•	•	•	•	573172	
RE 32	2	•	•	•	•	573178		
RE 40	2	•	•	•	•	573176		
REHAU (GBR) EVERLOC	RH 16	2	•	•	•	•	573166	
	RH 20	2	•	•	•	•	573170	
	RH 25	2	•	•	•	•	573154	
	RH 32	2	•	•	•	•	573156	
REVEL-PEX	RV 16	2	•	•	•	•	573400	
	RV 20	2	•	•	•	•	573402	
	RV 25	2	•	•	•	•	573404	
	RV 32	2	•	•	•	•	573406	
REVI REVIUNI	TC 12/14/16	2	•	•	•	•	573360	
	TC 18/20	2	•	•	•	•	573364	
	TC 25	2	•	•	•	•	573367	
	TC 32	2	•	•	•	•	573370	
REVI REVITERM Riquier à glissement	TC 12/14/16	2	•	•	•	•	573360	
	UNI 12	2	•	•	•	•	573630	
	UNI 16	2	•	•	•	•	573632	
	UNI 20	2	•	•	•	•	573636	
	UNI 25	2	•	•	•	•	573640	
	UNI 32	2	•	•	•	•	573644	
	UNI T/L**	1	•	•	•	•	573646	
Seppelfricke SD Sistemi Italia Sylver	Basic 25*	2	•	•	•	•	573616	
	RE 16	2	•	•	•	•	573160	
	RE 20	2	•	•	•	•	573162	
	RE 25	2	•	•	•	•	573172	
	RE 32	2	•	•	•	•	573178	
	RO 16	2	•	•	•	•	573184	
	RO 20	2	•	•	•	•	573186	
Seppelfricke SD Sistemi Italia Neroflex	RE 16	2	•	•	•	•	573160	
	RE 20	2	•	•	•	•	573162	
	RE 25	2	•	•	•	•	573172	
	RE 32	2	•	•	•	•	573178	
	RO 16	2	•	•	•	•	573184	
	RO 20	2	•	•	•	•	573186	
	TECE TECEflex	TC 12/14/16	2	•	•	•	•	573360
TC 18/20		2	•	•	•	•	573364	
TC 25		2	•	•	•	•	573367	
TC 32		2	•	•	•	•	573370	
TIEMME Assialpex	RE 16	2	•	•	•	•	573160	
	RE 20	2	•					



Expanding Extracting

	Hand tube expander Cu	250
	Expander head Cu	250
	One-hand pipe expander	251
	Hand tube expander P	251
	Cordless pipe expander Cu	252
	Cordless pipe expander P	252
	Cordless pipe expander P-CEF	252
	Electro-hydraulic pipe expander P-CEF	254
	Expander head P Expander head P-CEF	255
	Hand tube extractor	256
	Electric tube extractor Electric tube expander	257

REMS Ex-Press Cu

Hand tube expander

Proven quality tool for expanding and calibrating pipes for pipe installation without fittings.

Soft copper tubes $s \leq 1.5$ mm \varnothing 8–42 mm
 \varnothing $\frac{3}{8}$ – $1\frac{1}{8}$ "

Soft aluminium tubes,
soft precision steel tubes $s \leq 1.2$ mm \varnothing 8–42 mm
 \varnothing $\frac{3}{8}$ – $1\frac{1}{8}$ "

Soft stainless steel tubes $s \leq 1$ mm \varnothing 8–42 mm
 \varnothing $\frac{3}{8}$ – $1\frac{1}{8}$ "

REMS Ex-Press Cu – for making sockets yourself. 6-face mandrel for even and concentric expanding. Extra long sockets according to DVGW. Expander heads with calibration neck, fit other makes as well.

Cost advantage

Pipe installation without fittings. No costs for fittings, storage, procurement. Savings in soldering joints, soldering material and working hours. Using up pipe pieces to provide sockets.

Design

Robust quality tool. Torsion-free, power-transmitting expander levers with ergonomically designed handles, for effortless expanding. 6-face mandrel for even and concentric expanding. Extra long sockets, spring-loaded return of mandrel release. Also for other suitable makes of expander heads.

Expander heads

Quick-change. Extra long expander heads result in extra long sockets for perfect pipe connections according to DVGW. Special neck at expander head specially for calibration of deformed pipe ends.



German Quality Product



Info

Supply format

REMS Ex-Press Cu Set. Hand tube expander \varnothing 8–42 mm, \varnothing $\frac{3}{8}$ – $1\frac{1}{8}$ ". Soft copper tubes \varnothing 8–42 mm, \varnothing $\frac{3}{8}$ – $1\frac{1}{8}$ ", $s \leq 1.5$ mm, soft aluminium tubes and soft steel precision tubes \varnothing 8–42 mm, \varnothing $\frac{3}{8}$ – $1\frac{1}{8}$ ", $s \leq 1.2$ mm, soft stainless steel tubes \varnothing 8–42 mm, \varnothing $\frac{3}{8}$ – $1\frac{1}{8}$ ", $s \leq 1$ mm. Expander drive. Choice of expander heads for pipes in mm or inch. In sturdy steel case.

Description	Art.-No.
Set 12+15+18+22	150000
Set 12+15+22+28	150005
Set 15+18+22+28	150006
Set 12+15+18+22+28	150007
Set 12+14+16+18+22+28+32	150008
Set 12+14+16+18+22	150010
Set $\frac{3}{8}$+$\frac{1}{2}$+$\frac{5}{8}$+$\frac{3}{4}$+$\frac{7}{8}$+$1\frac{1}{8}$"	150017
Set $\frac{1}{2}$+$\frac{5}{8}$+$\frac{7}{8}$+$1\frac{1}{8}$"	150018
Set $\frac{3}{8}$+$\frac{1}{2}$+$\frac{5}{8}$+$\frac{7}{8}$"	150019
Set $\frac{3}{8}$+$\frac{1}{2}$+$\frac{5}{8}$+$\frac{3}{4}$+$\frac{7}{8}$+1"	150020



Accessories

Description	Pipes \varnothing mm/inch	Art.-No.
Expander head Cu (fit expander drives of REMS Ex-Press Cu 22 V ACC and other makes also)	8	150100
	10	150105
	12	150110
	14	150120
	15	150125
	16	150130
	18	150140
	20	150145
	22	150150
	24	150155
	25	150160
	26	150165
	28	150170
	30	150175
	32	150180
	34	150185
	35	150190
	36	150195
	40	150205
	42	150210
		$\frac{3}{8}$ "
	$\frac{1}{2}$ "	150225
	$\frac{5}{8}$ "	150230
	$\frac{3}{4}$ "	150235
	$\frac{7}{8}$ "	150240
	1"	150245
	$1\frac{1}{8}$ "	150250
Expander drive Cu (taper angle 18°)		150500
Steel case with insert		150600



REMS Ex-Press H

One-hand pipe expander

Robust, compact quality tool for expanding tubes.
For one-hand operation.

PEX tubes Serie S 5 according to ISO 4065 Ø 12–40 mm

REMS Ex-Press H – universal up to Ø 40 mm.

Robust, compact quality tool. Super light, only 0.7 kg.
Stepped mandrels for expanding several tube dimensions, no tool change required.
Torsion-free, leveraged expander tool for effortless expanding.
For one-hand operation.

Supply format

REMS Ex-Press H. One-hand pipe expander for PEX tubes Serie S 5 according to ISO 4065 Ø 12–40 mm. In a carton.

	Art.-No.
	150550



German Quality Product



REMS Ex-Press P

Hand tube expander

Proven quality tool for expanding tubes.
Plastic tubes, multi-layer composite tubes Ø 12–32 mm

REMS Ex-Press P – for expanding tubes. Conical mandrel for even and concentric expanding.

Design

Robust quality tool. Torsion-free, power-transmitting expander levers with ergonomically designed handles, for effortless expanding. Conical mandrel (taper angle 18°) for even and concentric expanding. Long mandrel guidance, spring-loaded mandrel release. Also for other suitable makes of expander heads.

Expander heads for all common systems

Complete assortment of REMS expander heads P for all common compression sleeve systems (page 255). Quickly interchangeable, without tools. The REMS expander heads are system-specific and comply with the requirements of the respective compression sleeve system. Thus perfect system-conformity, exact expanding.

Supply format

REMS Ex-Press P Set. Hand tube expander for plastic tubes and multi-layer composite tubes Ø 12–32 mm. REMS Ex-Press P. Expander heads P for tubes in mm. In sturdy steel case.

Description	Compr. sleeve system	Art.-No.
Set AT P 16 + 20 + 25	aquatherm SHT PB/PE-Rohre	150021
Set AT V 16 + 20 + 25	aquatherm SHT Mehrschicht-Metall- verbundrohre	150033
Set IV 16/17 + 20/21 + 25/26	IVT PRINETO, Würth PRINETO	150026
Set RH HAS 17 + 20 + 25	REHAU RAUTHERM S (REHAU HAS)	150027
Set RH HIS 16 + 20 + 25	REHAU RAUTITAN flex/ gas flex/pink/his, General Fittings Serie 3400 PEX, REVEL, Seppelfricke SD Sistemi Italia Neroflex, TIEMME Assialpex	150028
Set RH MKV 16 + 20 + 25	REHAU RAUTITAN stabil/ gas stabil, General Fittings Serie 3400 PEX/AL/PEX, Seppelfricke SD Sistemi Italia Sylver	150022
Set RH 16 + 20 + 25	REHAU RAUTHERM (série S 5), REHAU (GBR) EVERLOC	150029
Set TC 16 + 18/20 + 25	TECE TECEflex, General Fittings Serie 3700 PEX / PEX/AL/PEX	150025

System-specific and/or national differences of the wall thickness (s) of tubes need to be considered selecting expander heads, see table page 255.

Accessories

Description	Art.-No.
Expander heads P see page 255.	
Expander drive REMS Ex-Press P (taper angle 18°)	150510
Steel case with insert	150600



German Quality Product



e.g.
aquatherm,
General Fittings,
IVT,
REHAU,
REVEL,
Seppelfricke,
TECE,
TIEMME,
Würth



REMS Ex-Press 22V ACC

Cordless pipe expander 20 kN with automatic return

Compact, handy power tool with automatic return for fast, easy expansion of pipes/rings. Li-Ion 22V Technology. For cordless and mains operation. For trade and industry. For the building site and the workshop.

Expander Cu

for holding the REMS Cu expander heads and suitable expander heads of other makes for:

Soft copper pipes, $s \leq 1.5 \text{ mm}$ $\varnothing 8 - 42 \text{ mm}$
 $\varnothing \frac{3}{8} - 1\frac{3}{4}''$

Soft aluminium pipes,
 soft precision steel pipes, $s \leq 1.2 \text{ mm}$ $\varnothing 8 - 42 \text{ mm}$
 $\varnothing \frac{3}{8} - 1\frac{3}{4}''$

Soft stainless steel pipes, $s \leq 1 \text{ mm}$ $\varnothing 8 - 42 \text{ mm}$
 $\varnothing \frac{3}{8} - 1\frac{3}{4}''$

Expander P

for holding the REMS P expander heads and suitable expander heads of other makes for:

Plastic tubes, composite tubes $\varnothing 12 - 40 \text{ mm}$

Expander P-CEF

for holding the REMS P-CEF expander heads and suitable expander heads of other makes for:

Cold Expansion Fittings made of plastic (P-CEF)
 $\varnothing 16 - 40 \text{ mm}$
 $\varnothing \frac{1}{2} - 1\frac{1}{2}''$
 $s \leq 4.95 \text{ mm}$

REMS Ex-Press 22V ACC – fast, easy electric expanding up to $\varnothing 42 \text{ mm}$. With automatic return. Conical expanding mandrel for even centric expanding. E.g. REMS Ex-Press Cu 22V ACC with Li-Ion 21.6 V, 2.5 Ah battery for approx. 600 expansions of soft copper pipe $15 \times 1 \text{ mm}$ with one battery charge*.

System advantage

Only **one** drive unit, optionally with **expander Cu** for holding the REMS Cu expander heads and suitable expander heads of other makes, **expander P** for holding the REMS P expander heads and suitable expander heads of other makes, **expander P-CEF** for holding the REMS P-CEF expander heads and suitable expander heads of other makes.

Expander heads for all common systems

Quick-change, without tools. Also for other suitable makes of expander tongs.

REMS expander heads Cu (page 250) with extra long segments provide an extra long muff for a perfect pipe joint in accordance with DVGW. Collar on the expander head for calibrating unround pipe ends.

REMS expander heads P (page 255) are system-specific and correspond to the requirements of the respective compression sleeve systems. Therefore, perfectly system-conformant, exact expanding.

REMS expander heads P-CEF (page 255) are system-specific and correspond to the requirements of the respective systems. Automatic, gradual expansion until reaching the given end position which is determined by the expander head.

Design

Ultra light, ultra small, ultra handy. Drive unit with battery pack weighs only 2.7 kg. Drive unit with expander only 26 cm long. Can therefore be used anywhere, free hand, over head, also in very confined spaces. Optimum weight distribution for one-hand operation. Ergonomically designed housing. LED work light for illuminating the work place. Expanding mandrel of the Cu and P expanders with conical angle 18° , expanding mandrel of the P-CEF expander with conical angle 20° , or even centric expanding. Long mandrel guide, spring-loaded mandrel recoil. Also for other suitable makes of expander heads.

Drive

High expanding force for perfect, split-second expanding. Thrust force 20 kN. Powerful electro-hydraulic drive with automatic return (ACC), with powerful battery motor 21.6V, 380W output, robust planetary gear, eccentric reciprocating pump and compact high power hydraulic system. Safety switch.



REMS Ex-Press Cu

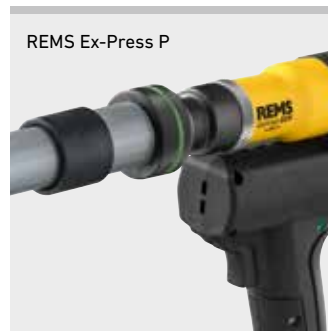

REMS Ex-Press P



REMS Ex-Press P-CEF

German Quality Product



Info

Battery or mains operation

Li-Ion 22V Technology. Highly resistant Li-Ion 21.6V battery with 2.5, 4.4, 5.0 or 9.0 Ah capacity, for long service life. Light and powerful.

REMS Ex-Press Cu 22V ACC with Li-Ion 21.6 V, 2.5 Ah battery for approx. 600 expansions, 4.4 Ah for approx. 1050 expansions, 5.0 Ah for approx. 1200 expansions, 9.0 Ah for approx. 2160 expansions of soft copper pipe $15 \times 1 \text{ mm}$ with one battery charge*.

REMS Ex-Press P 22V ACC with Li-Ion 21.6 V, 2.5 Ah battery for approx. 750 expansions, 4.4 Ah for approx. 1320 expansions, 5.0 Ah for approx. 1500 expansions, 9.0 Ah for approx. 2700 expansions of REHAU RAUTITAN flex $\varnothing 16 \times 2.2 \text{ mm}$ with one battery charge*.

REMS Ex-Press P-CEF 22V ACC with Li-Ion 21.6 V, 2.5 Ah battery for approx. 200 expansions, 4.4 Ah for approx. 360 expansions, 5.0 Ah for approx. 410 expansions, 9.0 Ah for approx. 740 expansions of Uponor Quick & Easy $\varnothing 16 \times 1.8$ with one battery charge*.

Graduated charging status check by coloured LEDs. Operating temperature range -10 to $+60^\circ\text{C}$. No memory effect for maximum battery power. Rapid charger 100–240V, 90W. Rapid charger 100–240V, 290W, for shorter charging times, as accessory. Voltage supply 220–240V/21.6 V, 15 A output, for mains operation instead of Li-Ion xbattery 21.6 V, as accessory.

Supply format

REMS Ex-Press Cu 22V ACC Basic-Pack. Cordless pipe expander 20 kN for fast expanding of copper pipes Ø 8–42 mm. Electro-hydraulic drive with automatic return, with powerful 21.6V, 380W battery motor, robust planetary gear, eccentric reciprocating pump and compact high power hydraulic system, safety switch. LED work light. Li-Ion 21.6V, 2.5Ah battery, 220–240V, 50–60 Hz, 70W rapid charger. Cu expander for holding the REMS Cu expander heads and suitable expander heads of other makes. Without expander heads. In sturdy steel case.

	Art.-No.
	575020

Other voltages on request.



Supply format

REMS Ex-Press P 22V ACC Basic-Pack. Cordless pipe expander 20 kN for fast expanding of plastic and composite tubes Ø 12–40 mm. Electro-hydraulic drive with automatic return, with powerful 21.6V, 380W battery motor, robust planetary gear, eccentric reciprocating pump and compact high power hydraulic system, safety switch. LED work light. Li-Ion 21.6V, 2.5 Ah battery, 220–240V, 50–60 Hz, 70W rapid charger. P expander for holding the REMS P expander heads and suitable expander heads of other makes. Without expander heads. In sturdy steel case.

	Art.-No.
	575021

Other voltages on request.



e.g.
aquatherm,
General Fittings,
IVT,
REHAU,
REVEL,
Seppelfricke,
TECE,
TIEMME,
Würth

Supply format

REMS Ex-Press P-CEF 22V ACC Basic-Pack. Cordless pipe expander 20 kN for fast expanding of plastic tubes Ø 16–40 mm. Electro-hydraulic drive with automatic return, with powerful 21.6V, 380W battery motor, robust planetary gear, eccentric reciprocating pump and compact high power hydraulic system, safety switch. LED work light. Li-Ion 21.6V, 2.5Ah battery, 220–240V, 50–60 Hz, 70W rapid charger. P-CEF expander for holding the REMS P-CEF expander heads and suitable expander heads of other makes. Without expander heads. In sturdy steel case.

	Art.-No.
	575022

Other voltages on request.



e.g.
Brass & Fittings,
Uponor

Accessories

Description	Art.-No.
REMS Ex-Press 22V ACC drive unit, without expander, without battery	575010
Expander Cu for holding the REMS Cu expander heads and suitable expander heads of other makes for: Conical angle 18°.	575252
Expander heads Cu see page 250	
Expander P for holding the REMS P expander heads and suitable expander heads of other makes for: Conical angle 18°.	575253
Expander heads P see page 255.	
Expander P-CEF for holding the REMS P-CEF expander heads and suitable expander heads of other makes for: Conical angle 20°.	575256
Expander heads P-CEF see page 255.	
Expander tongs P-CEF (conical angle 20°), for accommodating the expander heads P-CEF 16–40 mm, ½–1½"	150515
Battery Li-Ion 21.6V, 2.5 Ah	571571
Battery Li-Ion 21.6V, 4.4 Ah	571574
Battery Li-Ion 21.6V, 5.0 Ah	571581
Battery Li-Ion 21.6V, 9.0 Ah	571583
Rapid charger 100–240V, 50–60 Hz, 90W	571585
Rapid charger 100–240V, 50–60 Hz, 290W	571587
Voltage supply 220–240V/21.6V, 50–60 Hz, 15A, for mains operation instead of battery Li-Ion 21.6 V.	571567
Steel case with insert	578290
REMS Lumen 2800 22V, cordless LED flood light, see page 111	



REMS Power-Ex-Press P-CEF ACC

Electro-hydraulic pipe expander 34 kN with automatic return

Compact, handy power tool for fast, easy expanding of pipes/rings. For trade and industry. For the building site and the workshop.

Cold Expansion Fittings made of plastic (P-CEF)

Ø 16–63 mm

Ø ½–2"

s ≤ 6.3 mm

REMS Power-Ex-Press P-CEF ACC – Fast, easy electric expanding up to Ø 63 mm. With automatic return. For Uponor Quick & Easy and Giacomini GX System.

Expander heads

Large expanding capacity up to Ø 63 mm. Automatic, gradual expansion until reaching the given end position which is determined by the expander head. Use of the REMS P-CEF expander heads and suitable expander heads of other makes for: Expander 50–63 mm, 2", for holding the REMS P-CEF expander heads 50–63 mm, 2" and suitable expander heads of other makes. Expander 16–40 mm, ½–1½", for holding the REMS P-CEF expander heads 16–40 mm, ½–1½" and suitable expander heads of other makes, as an accessory.

Execution

Compact, robust, job site-proven. Small in size, slender design, drive unit only 5.6 kg. Works anywhere, free-hand, overhead, in confined areas. Ideal weight distribution for single handed operation. Ergonomically designed housing with recessed grip.

Drive

High pressing force for fast, perfect expanding. Thrust force 34 kN. Powerful electro-mechanical drive with automatic return (ACC), with proven universal motor, 450 W, maintenance-free gear with safety slipping clutch and in-feed system with machine screw spindle. Safety tip switch.



German Quality Product



Supply format

REMS Power-Ex-Press P-CEF ACC Basic-Pack. Electro-hydraulic pipe expander 34 kN for expanding tubes/coils of the Uponor Quick & Easy system Ø 16–63 mm, Ø ½–2", s ≤ 6.3 mm. Electro-hydraulic drive with automatic retraction, with proven universal motor 230 V or 110 V, 50–60 Hz, 450 W, robust planetary gear, eccentric reciprocating pump and compact high power hydraulic system. Safety tip switch. Expanding device 50–63 mm, 2". Without expander heads. In sturdy steel case.

	Art.-No.	
	575017	

Note assembly instructions of system supplier. Battery tube expander for other systems on request. Other voltages on request.

Accessories

Description	Art.-No.	
Expander 16–40 mm, ½–1½" , for holding the P-CEF expander heads 16–40 mm, ½–1½"	575100	
Expander heads P-CEF see page 255.		
Steel case with insert	575278	



REMS expander heads P REMS expander heads P-CEF

REMS expander heads P

Complete assortment of REMS expander heads P for all common compression sleeve systems. Quickly interchangeable, without tools. The REMS expander heads are system-specific and comply with the requirements of the respective compression sleeve system. Thus perfect system-conformity, exact expanding. Conical angle 18°. Driven by REMS Ex-Press P hand pipe expander (page 251), REMS Ex-Press P 22 V ACC cordless pipe expander (page 252 – 253) and by suitable pipe expanders of other makes.

Compression sleeve system	Expander head P Ø × s	Art.-No.
aquatherm grey pipe PB/PE-RT-Rohre	AT P 14 × 2.0	150828
	AT P 16 × 2.0	150842
	AT P 18 × 2.0	150873
	AT P 20 × 2.0	150882
	AT P 25 × 2.3	150912
aquatherm grey pipe Mehrschicht- Metallverbundrohre (MVR)	AT V 16 × 2.4	150843
	AT V 20 × 2.4	150883
	AT V 25 × 2.7	150913
	AT V 32 × 3.2	150957
	AT V 40 × 3.5	150958
General Fittings Serie 3400 PEX Gold-Fix	RH HIS 16 × 2.2	150849
	RH HIS 20 × 2.8	150888
	RH HIS 25 × 3.5	150916
	RH HIS 32 × 4.4	150945
General Fittings Serie 3400 PEX/AL/PEX Gold-Fix	RH MKV 16.2 × 2.6	150858
	RH MKV 20 × 2.9	150897
	RH MKV 25 × 3.7	150926
	RH MKV 32 × 4.7	150952
General Fittings Serie 3700 PEX	TC 16	150855
	TC 18/20	150894
	TC 25	150923
	TC 32	150950
General Fittings Serie 3700 PEX/AL/PEX	TC 16	150855
	TC 18/20	150894
	TC 25	150923
	TC 32	150950
HERZ QUICK FIX	HC P 16 × 2.0	150806
	HC P 20 × 2.0	150807
	HC P 26 × 3.0	150808
	HC P 32 × 3.0	150809
IVT PRINETO	IV 16 × 2.2/17 × 2.8	150845
	IV 20 × 2.8/21 × 3.4	150885
	IV 25 × 3.5/26 × 4.0	150914
	IV 32 × 4.4/33 × 4.9	150943
ÖÄG COMDURO	HC P 16 × 2.0	150806
	HC P 20 × 2.0	150807
	HC P 26 × 3.0	150808
	HC P 32 × 3.0	150809
REHAU RAUTHERM (série S 5)	RH 12 × 1.1	150812
	RH 16 × 1.5	150846
	RH 20 × 1.9	150886
	RH 25 × 2.3 (RH HAS 25 × 2.3)	150915
	RH 32 × 2.9 (RH HAS 32 × 2.9)	150944
REHAU RAUTHERM S (REHAU HAS)	RH HAS 17 × 2.0	150868
	RH HAS 20 × 2.0	150887
	RH HAS 25 × 2.3	150915
	RH HAS 32 × 2.9	150944
REHAU RAUTITAN flex/ RAUTITAN gas flex/ RAUTITAN pink/ RAUTITAN his	RH HIS 16 × 2.2	150849
	RH HIS 20 × 2.8	150888
	RH HIS 25 × 3.5	150916
	RH HIS 32 × 4.4	150945
	RH HIS 40 × 5.5	150946
REHAU RAUTITAN stabil/ RAUTITAN gas stabil	RH MKV 16.2 × 2.6	150858
	RH MKV 20 × 2.9	150897
	RH MKV 25 × 3.7	150926
	RH MKV 32 × 4.7	150952
REHAU (GBR) EVERLOC	RH 16 × 1.5	150846
	RH 20 × 1.9	150886
	RH 25 × 2.3 (RH HAS 25 × 2.3)	150915
	RH 32 × 2.9 (RH HAS 32 × 2.9)	150944
REVEL	RH HIS 16 × 2.2	150849
	RH HIS 20 × 2.8	150888
	RH HIS 25 × 3.5	150916
	RH HIS 32 × 4.4	150945
Seppelfricke SD Sistemi Italia Neroflex	RH HIS 16 × 2.2	150849
	RH HIS 20 × 2.8	150888
	RH HIS 25 × 3.5	150916
	RH HIS 32 × 4.4	150945
Seppelfricke SD Sistemi Italia Sylver	RH MKV 16.2 × 2.6	150858
	RH MKV 20 × 2.9	150897
	RH MKV 25 × 3.7	150926
	RH MKV 32 × 4.7	150952

System-specific and/or national differences of the wall thickness (s) of tubes need to be considered selecting expander heads. REMS expander heads P for additional compression sleeve systems on request.

Accessories for REMS pipe expander and other makes

Choose expander heads yourself!

Search for the required compression sleeve system in the table below and select the correct expander heads.



German Quality Product

REMS expander heads P

Complete assortment of REMS expander heads P for all common compression sleeve systems. Quickly interchangeable, without tools. The REMS expander heads are system-specific and comply with the requirements of the respective compression sleeve system. Thus perfect system-conformity, exact expanding. Conical angle 18°. Driven by REMS Ex-Press P hand pipe expander (page 251), REMS Ex-Press P 22 V ACC cordless pipe expander (page 252 – 253) and by suitable pipe expanders of other makes.

Compression sleeve system	Expander head P Ø × s	Art.-No.
TIEMME Assialpex	RH HIS 16 × 2,2	150849
	RH HIS 20 × 2,8	150888
	RH HIS 25 × 3,5	150916
	RH HIS 32 × 4,4	150945
Würth PRINETO	IV 16 × 2.2/17 × 2.8	150845
	IV 20 × 2.8/21 × 3.4	150885
	IV 25 × 3.5/26 × 4.0	150914
	IV 32 × 4.4/33 × 4.9	150943

System-specific and/or national differences of the wall thickness (s) of tubes need to be considered selecting expander heads. REMS expander heads P for additional compression sleeve systems on request.



REMS expander heads P-CEF

Full range of REMS P-CEF expander heads for easy expanding of pipes/rings. Quick-change, without tools. The REMS P-CEF expander heads are system-specific and correspond to the requirements of the respective systems. Therefore, perfectly system-conformant, exact expanding. Conical angle 20°. Driven by REMS Ex-Press P-CEF 22 V ACC cordless pipe expander (page 252 – 253), REMS Power-Ex-Press P-CEF ACC electro-hydraulic pipe expander (page 254) and by suitable pipe expanders of other makes.

Compression sleeve system	Expander head P-CEF Ø × s	Art.-No.
Uponor Quick & Easy	P-CEF 16 × 1.8	150960
	P-CEF 20 × 1.9	150961
	P-CEF 25 × 2.3	150962
	P-CEF 32 × 2.9	150963
	P-CEF 40 × 3.7	150968
Expander drive P-CEF (taper angle 20°), for holding the P-CEF expander heads 16 – 40 mm, ½ – 1½"		150515

System-related and/or national differences of the wall thickness s of the pipes must be considered in the selection of the expander heads.

REMS Hurrican H

Hand tube extractor

Economic manual tool for efficiently making T-branches for pipe installations without fittings.

Hard and soft copper tubes \varnothing 10–22 mm
 \varnothing $\frac{3}{8}$ – $\frac{7}{8}$ "
 $s \leq 1.5$ mm

REMS Hurrican H – for making T-branches yourself. Inexpensive. Also on tubes already installed.

System advantage

Only **one** type of extractor tools for REMS Hurrican H, REMS Hurrican and REMS Twist/Hurrican. Simple, inexpensive storage. No confusion possible.

Cost advantage

No costs for T-pieces, storage, procurement. Savings in soldering joints, pressing joints and working hours. Higher safety by fewer tube joints.

Design

Compact, handy, light. Can be used anywhere, free-hand, on pipes already installed. Drill head for exact drilling start without centre punching, drilling depth stop according to size of the T-outlet. Limitation of insertion depth to avoid obstruction by using the dimpling pliers. Handy gripping tongs for fixing the tool holder on the pipe, as an accessory.

Drill head drive

Drive with conventional electric drill.

Extractor tools

Special design of extractor tools facilitate even and smooth material deformation without burrs and notches. Therefore no secondary treatment required.

Tool holder drive

With standard ratchet and hexagon socket 11 mm or with spanner. Upgrade to electric pipe neck expander by buying the REMS Twist/Hurrican drive machine.



German Quality Product



Info



Supply format

REMS Hurrican H Set. Hand tube extractor for hard and soft copper tubes \varnothing 10–22 mm, \varnothing $\frac{3}{8}$ – $\frac{7}{8}$ " , $s \leq 1.5$ mm. Tool holder, drill head, dimpling pliers, lubricant. Extractor tools for tubes in mm or inch. In sturdy case.

Description	Art.-No.
Set 12 + 15 + 18 + 22	151003
Set 12 + 14 + 16 + 18 + 22	151004
Set $\frac{3}{8}$ + $\frac{1}{2}$ + $\frac{5}{8}$ + $\frac{3}{4}$ + $\frac{7}{8}$"	151005

Accessories

Description	Tubes \varnothing mm/inch	Art.-No.
Extractor tool	10	151105
	12	151110
	14	151120
	15	151125
	16	151130
	18	151140
	20	151145
	22	151150
	$\frac{3}{8}$ "	151155
	$\frac{1}{2}$ "	151160
	$\frac{5}{8}$ "	151165
	$\frac{3}{4}$ "	151170
	$\frac{7}{8}$ "	151175
REMS Twist/Hurrican drive unit with stabiliser		151402
Grip wrench for clamping the tool holder		076117
Tool holder		151200
Drill head		151210
Dimpling pliers		151230
Ratchet $\frac{1}{2}$"		074021
Hexagon socket 11 mm		074041
Lubricant (tin)		151240
Case with inlay		151618



REMS Hurrigan

Electric tube extractor

Powerful, compact electric tool for efficient machining of T-branches of hard and soft tubes for tube installations without fittings.

Hard and soft copper tubes \varnothing 10–22 mm
 \varnothing $\frac{3}{8}$ – $\frac{7}{8}$ "
 $s \leq 1.5$ mm

REMS Hurrigan – for making T-branches yourself. Inexpensive. Also on tubes already installed.

System advantage

Only one type of extractor tools for REMS Hurrigan H, REMS Hurrigan and REMS Twist/Hurrigan. Simple, inexpensive storage. No confusion possible.

Cost advantage

No costs for T-branches, storage, procurement. Savings in soldering joints, soldering material and working hours. Higher safety by fewer tube joints.

Design

Compact, handy, light. Can be used anywhere, free-hand, on pipes already installed. Drill head provides precise drilling without punching with any standard power drill. Drill depth-stop according to the size of T-branch. Tool holder for holding the extractor tools. Limitation of insertion depth to avoid obstruction by using the dimpling pliers. Handy grip wrench for clamping the tool holder onto the pipe.

Drive

Proven drive unit with hexagon mount. Enormously powerful. Handy, light, only 1.5 kg. Can be used anywhere, free-hand, also on pipes already installed. Robust, maintenance-free gear with safety slipping clutch. Universal motor, 630 W, high-torque forward and reverse at low speed. Stepless, electronic speed control. The speed can be continuously controlled electronically by variable pressure on the safety switch from 0 to 1,000 rpm (accelerator switch).

Extractor tools

Special design of extractor tools facilitate even and smooth material deformation without burrs and notches. Therefore no secondary treatment required.

REMS Twist/Hurrigan

Space and weight-saving combination set for efficient production of T-branches and for efficient cold-expanding of hard and soft tubes for installations without fittings. Only one drive unit for expanding and extracting tools. Price advantage! See page 259.



German Quality Product



Info



Supply format

REMS Hurrigan Set. Electric tube extractor for hard and soft copper tube \varnothing 10–22 mm, \varnothing $\frac{3}{8}$ – $\frac{7}{8}$ ", $s \leq .5$ mm. Drive unit with hexagon mount, maintenance-free gear, universal motor 230 V or 110 V, 50–60 Hz, 630 W. High torque at low speed, left and right-hand rotation. Safety tip switch. Continuous, electronic speed control from 0 to 1,000 rpm (accelerator switch). Drive holder. Tool holder, drill head, dimpling pliers, lubricant. Extractor tools for pipes in mm or inch. In sturdy steel case.

Description	Art.-No.
Set 12 + 15 + 18 + 22	151000
Set 12 + 14 + 16 + 18 + 22	151010
Set $\frac{3}{8}$ + $\frac{1}{2}$ + $\frac{5}{8}$ + $\frac{3}{4}$ + $\frac{7}{8}$"	151002

Other voltages on request.

Accessories

Description	Tubes \varnothing mm/inch	Art.-No.
Extractor tool	10	151105
	12	151110
	14	151120
	15	151125
	16	151130
	18	151140
	20	151145
	22	151150
	$\frac{3}{8}$ "	151155
	$\frac{1}{2}$ "	151160
	$\frac{5}{8}$ "	151165
	$\frac{3}{4}$ "	151170
$\frac{7}{8}$ "	151175	
REMS Twist/Hurrigan drive unit with stabiliser		151402
Tool holder		151200
Drill head		151210
Dimpling pliers		151230
Lubricant (tin)		151240
Case with inlay		151618



Powerful, compact power tool for rational cold expanding of hard and soft copper pipes for pipe installation without fittings.

Hard and soft copper tubes	Ø 12 – 22 mm Ø 3/8 – 7/8" s ≤ 1 mm
----------------------------	--

REMS Twist – for making sockets yourself. Cold-expanding of hard copper pipes.

Cost advantage

No costs for annealing hard copper tubes, for deburring and cleaning, for fittings, storage, procurement. Savings in soldering joints, soldering material and working hours. Higher safety by fewer tube joints. Using up tube pieces to make sockets.

Design

Compact, robust, job site-proven. Simple and fast working free-hand, at vice or workbench. No adjustments. Integrated clamping device provides safe support against torque in both directions.

Drive

Proven drive unit with hexagon mount. Enormously powerful. Handly, light, only 1.5 kg. Can be used anywhere, free-hand, also on pipes already installed. Robust, maintenance-free gear with safety slipping clutch. Universal motor, 630 W, high-torque forward and reverse at low speed. The speed can be continuously controlled electronically by variable pressure on the safety switch from 0 to 1,000 rpm (accelerator switch).

Expander tools

One quick-changing expander tool of each tube size with rotating mandrel for easy expanding and smooth operation. Without annealing, standard socket in just a few seconds, extra long.

REMS Twist/Hurricane

Space and weight-saving combination set for efficient production of T-branches and for efficient cold-expanding of hard and soft tubes for installations without fittings. Only one drive unit for expanding and extracting tools. Price advantage! See page 259.



German Quality Product



Supply format

REMS Twist Set. Electric tube expander for hard and soft copper tubes Ø 12 – 22 mm, Ø 3/8 – 7/8", s ≤ 1 mm. Drive unit with hexagon mount, maintenance-free gear, universal motor 230 V or 110 V, 50 – 60 Hz, 630 W. High torque at low speed, left and right-hand rotation. Safety tip switch. Continuous, electronic speed control from 0 to 1,000 rpm (accelerator switch). Drive holder. Lubricant. Expander tools for mm or inch. In sturdy steel case.

Description	Art.-No.
Set 12 + 15 + 18 + 22	156000
Set 12 + 14 + 16 + 18 + 22	156002
Set 3/8 + 1/2 + 5/8 + 3/4 + 7/8"	156004

Other voltages on request.

Accessories

Description	Tubes Ø mm/inch	Art.-No.
Expander tool	12	156150
	14	156200
	15	156225
	16	156250
	18	156300
	22	156350
	3/8"	156375
	1/2"	156400
	5/8"	156425
	3/4"	156450
7/8"	156475	
REMS Twist/Hurricane drive unit with stabiliser		151402
Lubricant (tin)		151240
Steel case with insert		151600



REMS Twist/Hurrican

Electric tube extractor
Electric tube expander

Powerful, compact power tool for rational manufacture of T-joints and rational cold expanding of hard and soft copper pipes for pipe installation without fittings. Combination of REMS Twist and REMS Hurrican.

Extracting:
Hard and soft copper tubes \varnothing 10–22 mm
 \varnothing $\frac{3}{8}$ – $\frac{7}{8}$ "
 $s \leq 1.5$ mm

Expanding:
Hard and soft copper tubes \varnothing 12–22 mm
 \varnothing $\frac{3}{8}$ – $\frac{7}{8}$ "
 $s \leq 1$ mm

**REMS Hurrican for making T-branches yourself.
Inexpensive. Also on tubes already installed.**

**REMS Twist for making sockets yourself.
Cold-expanding of hard copper tubes.**

Space and weight saving combi set. Only **one** drive unit for expander and extractor tools. Price advantage!

Description see REMS Hurrican and REMS Twist (page 257–258).

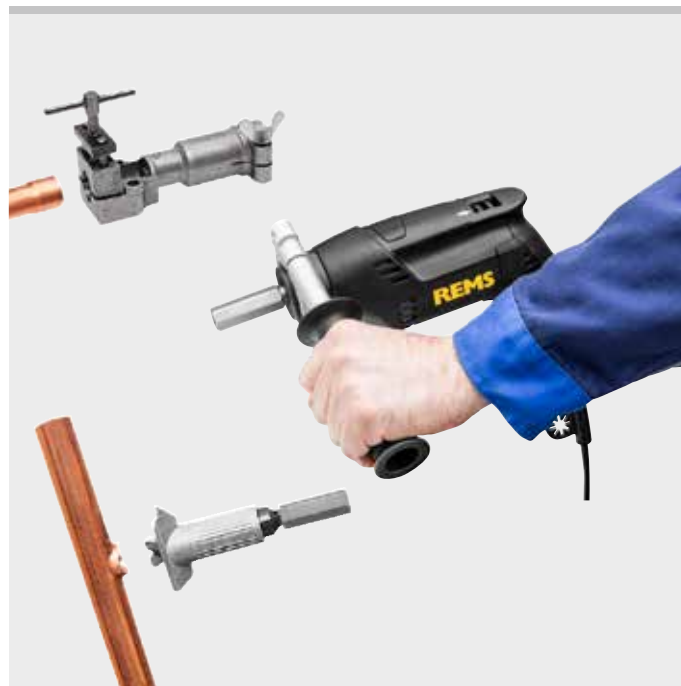

German Quality Product



Info

Supply format

REMS Twist/Hurrican Combi Set. Electric tube expander and electric tube extractor for hard and soft copper tubes. Expanding \varnothing 12–22 mm, \varnothing $\frac{3}{8}$ – $\frac{7}{8}$ " , $s \leq 1$ mm, extracting \varnothing 10–22 mm, \varnothing $\frac{3}{8}$ – $\frac{7}{8}$ " , $s \leq 1.5$ mm. Drive unit with hexagon mount, maintenance-free gear, universal motor 230 V or 110 V, 50–60 Hz, 630 W. High torque at low speed, left and right-hand rotation. Stepless, electronic safety switch. Drive holder. Tool holder, drill head, dimpling pliers, lubricant. Choice of expander and extractor tools for pipes in mm or inch. In sturdy steel case.

Description	Art.-No.
Set 12 + 15 + 18 + 22	156010
Set 12 + 14 + 16 + 18 + 22	156012
Set $\frac{3}{8}$ + $\frac{1}{2}$ + $\frac{5}{8}$ + $\frac{3}{4}$ + $\frac{7}{8}$ "	156014

Other voltages on request.



Accessories

Description	Tubes \varnothing mm/inch	Art.-No.
Expander tool	12	156150
	14	156200
	15	156225
	16	156250
	18	156300
	22	156350
	$\frac{3}{8}$ "	156375
	$\frac{1}{2}$ "	156400
	$\frac{5}{8}$ "	156425
	$\frac{3}{4}$ "	156450
$\frac{7}{8}$ "	156475	
Extractor tool	10	151105
	12	151110
	14	151120
	15	151125
	16	151130
	18	151140
	20	151145
	22	151150
	$\frac{3}{8}$ "	151155
	$\frac{1}{2}$ "	151160
$\frac{5}{8}$ "	151165	
$\frac{3}{4}$ "	151170	
$\frac{7}{8}$ "	151175	
REMS Twist/Hurrican drive unit with stabiliser		151402
Tool holder		151200
Drill head 10–22 mm		151210
Drill head $\frac{3}{8}$–$\frac{7}{8}$"		151210
Dimpling pliers		151230
Lubricant (tin)		151240
Steel case with insert		151600



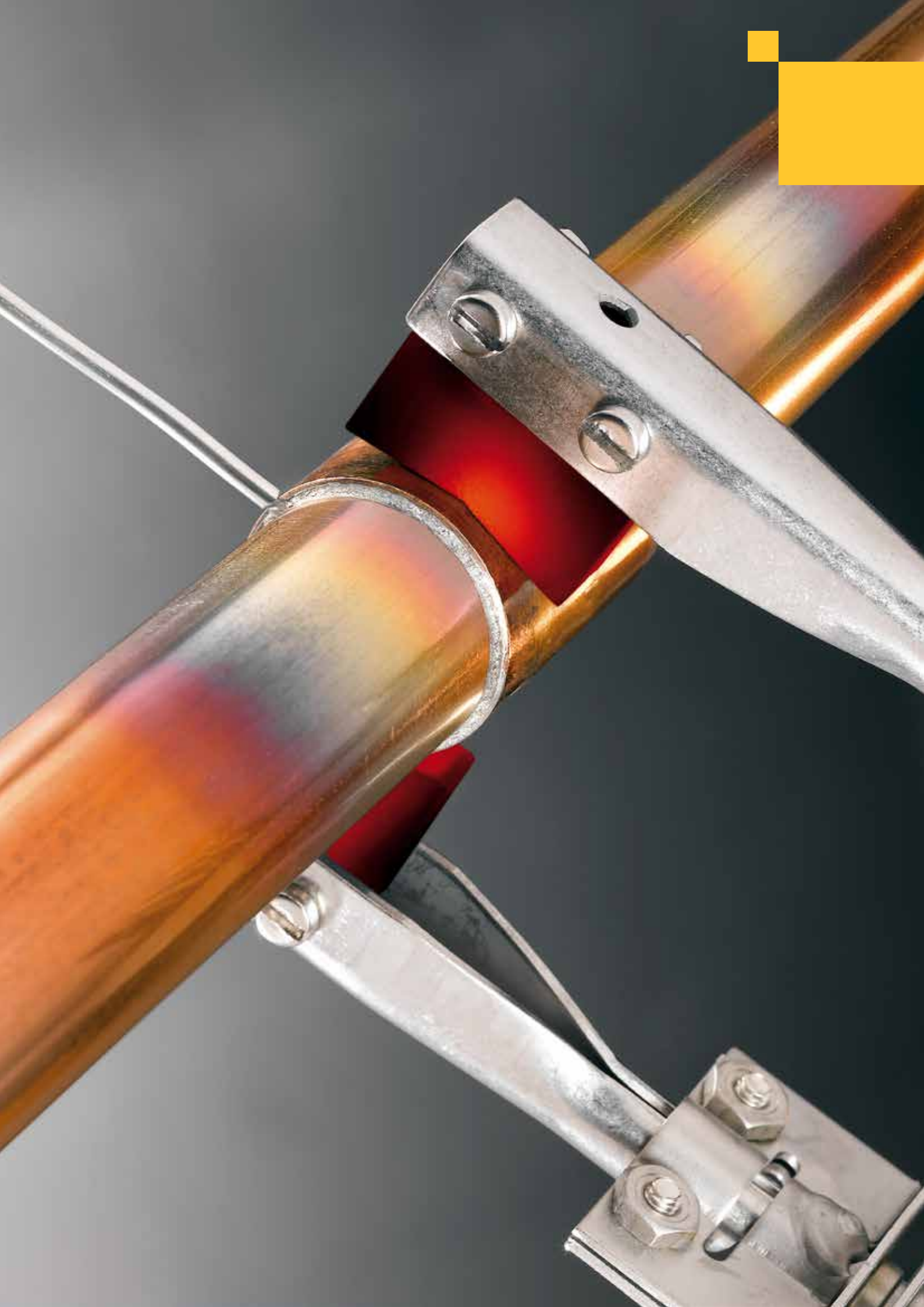

Soldering

	Cleaning pads	262
	Electric soldering pliers	262
	Electric soldering unit	263
	Turbo soldering torches	264
	Solder wire and solder paste	265

REMS Cu-Vlies

Cleaning pads

Metal-free, highly flexible cleaning pads for cleaning surfaces to be soldered on copper tubes and soldering fittings. Also for other materials.

REMS Cu-Vlies – clean surfaces according to DVGW.

Universal use, for many materials, highly flexible. Cleans metallic clear, dirt and oxide-free, according to DVGW work sheet GW 2. Clean finish. Multiple use, reusable by washing out, thus long service life. Can be used wet or dry.

Supply format

REMS Cu-Vlies. Metal-free, highly flexible cleaning pad for cleaning areas to be soldered on copper pipes and soldering fittings. Pack of 10.

	Art.-No.	
	160300	



German Quality Product

REMS Hot Dog 2

Electric soldering pliers

Efficient, light-weight electric tool for soft soldering. Directly connected to a socket, no transformer required. For trade and industry. For the building site and the workshop.

Copper tubes	Ø 10–28 mm Ø 3/8–1 1/8"
Heating capacity	800°C

REMS Hot Dog 2 – the smallest and most powerful soldering pliers. Super fast without flame.

Super fast soldering, e.g. Ø 18 mm in only 15 s. Enormous heating capacity up to 800°C through 2 heating cartridges. For permanent use.

Super light and handy, complete only 0.7 kg. Can be used anywhere, in confined areas also.



German Quality Product



Supply format

REMS Hot Dog 2 Set. Electric soldering pliers for soft soldering copper tubes Ø 10–28 mm, Ø 3/8–1 1/8". 230 V, 50–60 Hz, 440 W. 250 g REMS Lot Cu 3 and REMS Paste Cu 3. Cleaning brush. In steel case with fire retarding insert.

	Art.-No.	
	163020	

Other voltages on request.

Accessories

Description	Art.-No.	
REMS soldering material see page 265.		
Steel case with fire-proof inlay	163350	



REMS Contact 2000

Electric soldering unit

Compact, powerful electric tool for soft soldering. With safety transformer. For trade and industry. For the building site and the workshop.

Copper tubes	Ø 6–54 mm Ø ¼–2½"
Heating capacity	900°C (1650°F)

REMS Contact 2000 – the smallest, strongest and fastest unit of its kind. 2000 W soldering power. 4 m long soldering tongs cable.

Handy, compact. Favourable weight, small in size for work and transport. L x W x H: 210 x 150 x 140 mm.

Enormous heating capacity (900°C) ensures super-fast soldering. Rated power = Soldering capacity = 2000 W! Soldering time, e.g. for Ø 18 mm in only 18 s.

Can be used anywhere, with rod electrodes in tight spots also. Ready to solder any time, to be connected to a socket only. No adjustment of soldering current necessary. Wide work radius thanks to 4 m cable length. Flexible cable protector hose.

Indifferent to temperature influences electric control of soldering current.

Prisma-electrodes for universal use, maximum use through favorable seat. Rod-electrodes for working in tight spots. Electrode holders and bolts in stainless steel. Electrodes can be easily replaced.



Prisma-electrodes for universal use, maximum use through favorable seat.

German Quality Product



Info

Supply format

REMS Contact 2000. Electric soldering unit for soft soldering of copper tubes Ø 6–54 mm, Ø ¼–2½". 230 V, 50–60 Hz, 2000 W, control voltage 24 V. Soldering pliers with 4 m cable length. Safety transformer, 2 prism electrodes. In a carton.

	Art.-No.	
	164011	

Other voltages on request.

Supply format

REMS Contact 2000 Super-Pack. Electric soldering unit for soft soldering of copper tubes Ø 6–54 mm, Ø ¼–2½". 230 V or 110 V, 50–60 Hz, 2000 W, control voltage 24 V. Soldering pliers with 4 m cable length, safety transformer, 4 prism electrodes, 2 rod electrodes, 250 g quality soft solder REMS Lot Cu 3, 250 g quality soft solder paste REMS Paste Cu 3, 1 pipe cutter REMS RAS Cu-INOX 3-35, pack of 10 cleaning pads REMS Cu-Vlies. In sturdy steel case.

	Art.-No.	
	164050	

Accessories

Description	Art.-No.
Prism electrodes (pack of 2)	164111
Prism electrodes with holders (pack of 2)	164110
Rod electrodes (pack of 2)	164115
Steel case with insert	164250
REMS soldering material see page 265.	



REMS Blitz

Turbo soldering torch propane

Handy self-lighting torch with turbo-flame for fast soft soldering and economic gas consumption.

Copper tubes $\leq \varnothing 35 \text{ mm}$

Heating, annealing, burning, melting, thawing, shrinking and similar thermal procedures.

Flame temperature 1950°C (3500°F)

REMS Blitz – extremely fast soft soldering.

Piezo-electric self-lighting

Without igniter! Pull trigger – flame comes on! Release trigger – flame goes out! Little gas consumption, only 200 g/h!

Design

Super handy, ergonomic, with one hand only. No setting, no adjustment. Locking button for continuous operation. Only 1 universal flame tube. Small gas bottles can be used.

Turbo-flame

Spot-flame with turbo-twisting-booster for high heating capacity and super fast soft soldering.



German Quality Product



Info



Supply format

REMS Blitz. Turbo soldering torch propane for soft soldering of copper tubes $\leq \varnothing 35 \text{ mm}$. Piezo-electric self-lighting. Hose connector BSPP $\frac{3}{8}$ " LH. Hollow cap nut and socket BSPP $\frac{3}{8}$ " LH. In blister pack.

	Art.-No.	
	160010	

Accessories

Description	Art.-No.	
REMS soldering material see page 265.		
High pressure hose 3 m , BSPP $\frac{3}{8}$ " LH	152106	
Pressure reducer for 5 or 11 kg gas bottles (2 bar)	152109	



REMS Macho

Turbo soldering torch acetylene

Handy self-lighting torch with turbo-flame for extremely fast brazing and soft soldering. Economic gas consumption.

Copper tubes and others $\leq \varnothing 64 \text{ mm}$

Heating, annealing, burning, melting, thawing, shrinking and similar thermal procedures.

Flame temperature 2500°C

REMS Macho – super fast brazing.

Piezo-electric self-lighting

Without igniter! Pull trigger – flame comes on! Release trigger – flame goes out! Little gas consumption, only 360 g/h!

Acetylene only

Injection torch burns atmospheric oxygen. Hence only acetylene necessary.

Design

Super handy, ergonomic, with one hand only. No setting, no adjustment. Locking button for continuous operation. Only 1 universal flame tube.

Turbo-flame

Spot-flame with turbo-twisting-booster for extremely high heating capacity and super fast brazing.



German Quality Product



Info



Supply format

REMS Macho. Turbo soldering torch acetylene for brazing and soft soldering of copper tubes and others $\leq \varnothing 64 \text{ mm}$. Piezo-electric self-lighting. Hose connector BSPP $\frac{3}{8}$ " LH. Hollow cap nut and socket $\frac{3}{8}$ " LH. In blister pack.

	Art.-No.	
	161010	

Accessories

REMS soldering material see page 265.

REMS Lot Cu 3

Soft solder Sn97Cu3, ISO 9453:2014

Soft soldering of copper tubes with copper, red copper cast and brass fittings for cold and hot water installation, heating installation ≤ 110°C (230°F).

In accordance with DVGW work sheet GW 2.

Alloy (weight %)	97 % Sn, 3 % Cu
Melting temperature	230 – 250°C (450 – 480°F)

REMS Lot Cu 3 – quality soft solder.

Lead-free, harmless to health and environment.
Silver-free, complies with standards. Very low price.

Supply format

REMS Lot Cu 3. 250-g spool soft solder wire Sn97Cu3, ISO 9453:2014, Ø 3 mm, for soft soldering of copper tubes with copper, red copper cast and brass fittings for cold and hot water installation, heating installation ≤ 110°C (230°F).

	Art.-No.	
	160200	



German Quality Product

REMS Paste Cu 3

Soft solder paste of solder powder Sn97Cu3 according to ISO 9453:2014 and flux 3.1.1.C, EN 29454-1:1994

Soft soldering of copper tubes with copper, red copper cast and brass fittings for cold and hot water installation, heating installation ≤ 110°C (230°F).

In accordance with DVGW work sheet GW 7 (DVGW-Reg.-Nr. DV-0101AT2244)

REMS Paste Cu 3 – quality soft solder paste.

Lead-free, harmless to health and environment.
Silver-free, complies with standards. Very low price.

No additional flux consumption, paste contains flux already.
Thus less danger of corrosion.

No overheating of tube and fitting because the melting of solder and the required temperature for soldering is clearly visible through the change of colour of paste.

High filling level of soldering joint, thereby good stability. Easy cleaning of remnants which are soluble in cold water.

Plastic bottle with brush integrated in cap which cannot get lost.

Supply format

REMS Paste Cu 3. 250-g soft solder paste of solder powder Sn97Cu3 according to ISO 9453:2014 and flux 3.1.1.C, EN 29454-1:1994, for soft soldering of copper tubes with copper, red copper cast and brass fittings for cold and hot water installation, heating installation ≤ 110°C (230°F). DVGW approval mark. In plastic bottle with integrated brush.

	Art.-No.	
	160210	



German Quality Product

REMS Lot P6

Brazing solder ISO 17672-CuP 179

Brazing of copper tubes with copper, red copper cast and brass fittings in cold and hot water installation, gas installation, refrigerating and air conditioning applications.

In accordance with DVGW work sheet GW 2.

Alloy (weight %)	94 % Cu, 6 % P
Melting temperature	710 – 890°C (1310 – 1640°F)

REMS Lot P6 – quality brazing solder.

Universally applicable for almost all types of joints in copper pipe installations. Specially useful for capillary brazing joints of copper pipe installations without fittings. Wide melting range due to low phosphor content result in higher toughness of soldering joint.

Silver-free, complies with standards. Very low price.

Supply format

REMS Lot P6. 1 kg brazing solder (rods) ISO 17672-CuP 179, Ø 2 mm, for brazing of copper tubes with copper, red copper cast and brass fittings for cold and hot water installation, gas installation, refrigerating and air conditioning applications. In a carton.

	Art.-No.	
	160220	





Freezing



Pipe freezer CO₂

268



Electric pipe freezing unit

269

Simple, fast freezing of unemptied pipes with a carbon dioxide coolant. For repair, extensions of piping systems.

Steel, copper, plastic,
composite pipes

Ø 1/8 – 2"
Ø 10 – 60 mm

Refrigerant: carbon dioxide.

Refrigerating capacity to –79°C (–110°F).

Non toxic, non flammable.

REMS Eskimo – freezing instead of draining.
Super fast. Automatic refrigerant feed. High cooling capacity, e.g. 3/4" steel pipe in only 5 min.
Very small, indestructible freeze collars.

Refrigerant

Carbon dioxide coolant with high cooling performance up to –79°C. Non toxic. Non flammable. Easy to obtain.

Design

Tight contact between freeze collars and pipe and direct flow of the refrigerant onto the pipe ensure extremely short freezing times and economic refrigerant consumption. Freezing is possible on one or two sides, with additional T-distributors further freeze collars can also be connected.

Freeze collars

Easy. Rapid assembly, without special tools. Very small, highly flexible, indestructible freeze collars in cold-resistant thermoplastic elastomer, for operating even in the tightest spots. Clamping screws cannot get lost.

Handle piece with injector

Ergonomically designed handle pieces in plastic for comfortable operation. Unbreakable brass injector (injection nozzle). Fast and secure connection to freeze collars. No setting, the correct amount of refrigerant is automatically supplied.

High pressure hoses

Flexible, buckling-resistant and fractureproof high pressure hoses. Extra long for wide work radius. Extendable any time. Turnable hollow cap nut at bottle connector prevents high pressure hoses from tangling.



German Quality Product



Info



Supply format

REMS Eskimo Set. Pipe freezing device for carbon dioxide coolant. For steel, cast iron, lead, copper, plastic pipes Ø 1/8 – 2", Ø 10 – 60 mm. Two freezing jackets each in 10 different sizes for the whole working range, flange connection with T-junction, locking nut, 2 handles with injector, 2 high-pressure hoses. In sturdy carrying case.

	Art.-No.
	130002

Accessories

Description	Size	Art.-No.	
Freezing jacket	1/8"	10/12 mm	130450
	1/4"	15 mm	130455
	3/8"	18 mm	130460
	1/2"	22 mm	130465
	3/4"	28 mm	130470
	1"	35 mm	130475
	1 1/4"	42 mm	130480
	1 1/2"		130485
		54 mm	130490
		60 mm	130495
High-pressure hose 2 m		130415	
T-distributor for further collar		130207	
Bottle connection with T-distributor		130383	
Locking nut		130209	
Double nipple		130208	
Handle piece with injector		130410	
Case with inlay		130430	



REMS Frigo 2 F-Zero

Electric pipe freezing unit

Easy, fast freezing of pipes which are not drained.
Closed refrigerant circuit. Environmentally safe.
For repair and extension of piping systems.

Steel, copper, plastic,
composite pipes

Ø 1/8 – 2"
Ø 10 – 60 mm

REMS Frigo 2 F-Zero – electrically freezing instead of draining. Super fast up to 2". High cooling capacity, e.g. 3/4" steel pipe in only 9 min*. Particularly compact, patented deep-freezer heads, for very fast assembly. Temperature display with LCD digital thermometer.

System advantage

Only one pipe freezing unit for the complete working range up to 2". One-size freezer heads for the core working range Ø 1/4 – 1" / Ø 15 – 35 mm, no reducing inserts required. Aid the cooling process simply by spraying with water. Always clean freezer heads, no pastes/greases required.

Closed refrigerant circuit

Electric pipe freezing unit with closed refrigerant circuit. Environmentally safe. Can be used anywhere, also in closed rooms. Refrigerant R-290. High cooling capacity. Ideal also for longer repairs.

Design

Robust, compact. Very small deep-freezer heads fitted parallel to the pipe leaving refrigerant hoses for working in confined areas and niches also. Single or double freezing possible.

Cooling aggregate

Very quiet. Cooling aggregate, 430 W, in sturdy sheet metal housing with ventilating side openings for optimum air circulation. Large top compartment, easily accessible, for refrigerant hoses and accessories. Weighs only 23 kg. Easy to carry.

Deep-freezer heads

Very compact deep-freezer heads with special geometrically shaped cavities for seating different pipe diameters. Very small, only 50 mm wide. All pipe sizes from Ø 1/4 – 1" resp. Ø 15 – 35 mm can be frozen with only one deep-freezer head. Deep-freezer inserts for the rest of the capacity up to 2", 60 mm. Tightening straps for simple and quick assembly of deep-freezer heads onto the pipe, without tools.

Refrigerant hoses

Flexible, extra-long refrigerant hoses, 2.5 m long, in wear resistant, synthetic rubber for large work radius.

LCD-Digital-Thermometer

LCD digital thermometer with clip, for exact temperature display directly at the freezing points.



German Quality Product

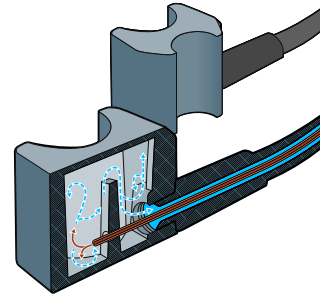

Super fast up to 2"



Supply format

REMS Frigo 2 F-Zero Set. Electric pipe freezing unit with closed refrigerant circuit. For steel, copper, plastic, composite pipes, Ø 1/8 – 2", Ø 10 – 60 mm. Cooling aggregate 230 V or 110 V, 50 Hz, 430 W, 2 refrigerant hoses, 2.5 m long, 2 LCD digital thermometers, 2 tightening straps, squirt bottle. Equipped for Ø 1/4 – 1", 15 – 42 mm. In sturdy sheet metal housing. In a carton.

	Art.-No.
	131012

Accessories

Description	Size	Art.-No.	
Extension kit up to 2", 60 mm	1 1/2 – 2" / 54 – 60 mm	131160	
Deep-freeze inserts (pack of 2)	1/8"	10, 12 mm	131110
	1/2"		131156
		54 mm	131157
	2"	60 mm	131158
Clamping band		131104	
LCD digital thermometer		131116	



*ambient/water temperature approx. 18°C.



2022-01-01 12:24:48PM

10 m

X 1.0

REMS CamSys 2

Pipe and Drain inspection

Pipe and Drain cleaning

	Endoscope cameras	272
	Electronic camera inspection systems	274
	Drain cleaner for manual and electric operation	280
	Electric drain cleaning machine	281
	Cordless drain cleaning machine	282
	Electric pipe and drain cleaning machines	284

Mobile, handy endoscope camera for low-cost inspection and damage analysis of places with difficult access such as cavities, shafts, pipes, etc. For cordless operation.

Camera head Ø 8 mm

REMS MiniScope – Brilliant pictures of cavities, shafts and pipes.

Design

Ultra light and handy. Controller unit with camera cable set only 0.4 kg. Can be used everywhere, free hand, over head, also in very confined spaces. Sturdy, impact-proof plastic housing with ergonomically shaped handle. The buttons are located directly underneath the display so that it is possible to hold the device by the handle and operate the buttons with one hand. On/Off button, button for rotating, mirroring of the image by 180° respectively, button for regulating the brightness of the LEDs in the camera head in 8 stages, button for regulating the brightness of the colour display in 8 stages. Power LED for indicating the operating state. Battery compartment for 4 commercially available 1.5V, AA, LR6 batteries. Plug-screw connections for changing the camera cable set without tools. Sturdy case for controller unit, camera cable set 8-1 and accessories.

Controller unit with TFT-LCD colour display

Controller unit with 2.3" colour display with state of the art TFT-LCD technology for brilliant pictures, 320 × 240 pixels.

Battery operation

Controller unit with four 1.5V, AA, LR6 batteries for approx. 6 hours of continuous operation.

Exchangeable camera cable set Color

Camera cable set Color, consisting of colour camera Ø 8 mm (640 × 480 pixels), with CMOS sensor, with dimmable white light LEDs for optimum setting of the brightness and fixed focus function, for automatic picture focus, protected against occasional immersion in water (IP 67). Camera cable set Color 8-1 with 1 m flexible push cable and add-on mirror, add-on hook, add-on magnet.



Info

Supply format

REMS MiniScope Set. Mobile, handy endoscope camera for low cost inspection and damage analysis of places with difficult access such as cavities, shafts, pipes etc. Controller unit with 2.3" TFT-LCD colour display. 4 batteries 1.5 V, AA, LR6. Camera cable set Color 8-1 with 1 m flexible push cable and add-on mirror, add-on hook, add-on magnet. In sturdy case.

	Art.-No.	
	175401	



REMS CamScope HD

Endoscope camera

Mobile, handy endoscope camera for low-cost inspection and damage analysis of places with difficult access such as cavities, shafts, pipes, etc. Documentation of photos and videos on MicroSD card. For battery and mains operation.

Camera head Ø 8 mm

REMS CamScope HD – Brilliant pictures and videos of cavities, shafts and pipes in HD quality (1920 × 1080 pixels). MicroSD card slot.

Design

Ultra light and handy. Controller unit with pistol grip and camera cable set only 0.5 kg. Can be used everywhere, free hand, over head, also in very confined spaces. Sturdy, impact-proof plastic housing with ergonomically shaped handle. The buttons are located directly underneath the display so that it is possible to hold the device by the pistol grip and operate the buttons with one hand. Bottoms, among other things, for regulating the brightness of the LEDs in the camera head and the display in 4 stages each, for rotating, mirroring and zooming the image shown in the display, calling and navigating in the menu. Power LED for indicating the operating state integrated into the On-Off button. Li-Ion 3.7 V battery with 4.0 Ah for long service life. Different HD camera cable sets can be used. Plug-screw connections for changing the camera cable sets without tools. Sturdy case of controller unit with pistol grip, camera cable set Color 8-1 HD, USB cable and accessories.

Controller unit with TFT-LCD colour display

Controller unit with pistol grip with 5" colour display with state-of-the-art TFT-LCD technology and 480 × 854 pixels, for brilliant pictures and videos. Selectable menu language. MicroSD card slot. Pictures and videos in HD quality can be saved on a MicroSD card for simple documentation of the inspection result. 4x digital zoom. The date and time of the recording can be saved in the photo and video as an option. Immediate playback of saved recordings or transmission to other devices via MicroSD card. USB port for direct connection to a PC or laptop and for charging the battery.

Cordless and mains operation

Li-Ion technology. Controller unit with pistol grip with integrated 3.7 V, 4.0 Ah Li-Ion battery. Light and powerful. High energy density for approx. 5 hours continuous operation. The unit can be used in mains mode whilst charging the battery with the USB cable. No memory effect for maximum battery performance.

Exchangeable camera cable set Color

Camera cable set Color HD, consisting of colour camera Ø 8 mm, with CMOS sensor, with dimmable white light LEDs for optimum setting of the brightness and fixed focus function, for automatic picture focus, protected against occasional immersion in water (IP 67). Camera cable set Color 8-1 HD with 1 m flexible push cable and add-on mirror, add-on hook, add-on magnet. Camera cable set Color 8-5 HD with 5 m flexible push cable as an accessory.



Info



Supply format

REMS CamScope HD Set. Mobile, handy endoscope camera for low cost inspection and damage analysis of places with difficult access such as cavities, shafts, pipes etc. Documentation of pictures and videos in HD quality on MicroSD card. Endoscope camera with 5" TFT-LCD colour display, 4x digital zoom, MicroSD card slot, USB port, integrated 3.7 V, 4.0 Ah Li-ion battery. Camera cable set Color 8-1 HD with 1 m flexible push cable and add-on mirror, add-on hook, add-on magnet. 32 GB MicroSD card. USB cable. In sturdy case.

	Art.-No.	
	175400	

Accessories

Description	Art.-No.	
Camera cable set Color 8-5 HD , colour camera Ø 8 mm, 1280 × 720 pixels, with 5 m formable push cable	175440	



Mobile, handy camera inspection system for inexpensive inspection and damage analysis of pipes, drains, chimneys and other hollow cavities. With electronic metering. Also for inspection after pipe cleaning work and for acceptance of new installations or repairs. Documentation of pictures and videos on SD card. For battery and corded operation.

Camera head	Ø 25 mm
Pipe	Ø (40) 50–150 mm
Drains, chimneys, other cavities	

REMS CamSys – Brilliant pictures and videos of pipes and drains. SD card slot. Electronic metering. Cordless and mains operation.

System advantage

Only **one** controller unit with TFT-LCD colour display for connecting different camera cable sets for different requirements. Therefore inexpensive conversion possible.

Design

Mobile, handy, light. Can be used everywhere, even in very narrow places. Controller unit connected to the camera cable set by a 2 m connecting cable, removable for easy cleaning of the camera cable set. Various camera cable sets can be used. Plug-screw connections for changing the camera cable sets and the controller unit without tools. Sturdy case for controller unit, voltage supply/charger and accessories.

Controller unit with TFT-LCD colour display

Controller unit with 3.5" colour display with state of the art TFT-LCD technology for brilliant pictures and videos, 89 mm screen diagonal, 320 x 240 pixels. Very light and handy, only 0.4 kg. Sturdy, impact-proof plastic housing, spray protected. Small dimensions: 172 x 121 x 58 mm. Keys for setting the brightness of the LEDs of the colour camera head. Full screen, 2x zoom, 4x rotation options for the picture. SD card slot. Pictures and videos can be saved on an SD card for simple documentation of the inspection result. Insertion depth of the camera is stored in the picture and the video, optionally also date and time of the recording. Pictures can be taken during video recording without impairing the video recording. Immediate playback of saved recordings or transmission to other devices with SD card. Pictures can also be taken later from the video during playback of recorded videos on the controller's colour display. USB connector for direct connection to PC or laptop. Video output socket Composite-Video PAL/NTSC for connecting an external monitor. Connection for voltage supply/charger Li-Polymer 100–240 V.

Cordless and mains operation

Li-Polymer Technology. Controller unit with integrated Li-Polymer battery 3.7V, 4.0 Ah. Light and powerful. Power supply/charger 100–240 V, 15 W, with USB port and USB cable for connecting power supply/charger, laptop or other voltage supply. No memory effect for maximum battery performance.

High resolution special colour camera

High resolution special colour camera Ø 25 mm with CMOS image sensor and 8 ultra bright, white LEDs with adjustable light intensity up to 1700 mcd and concentrated radiation angle for brilliant colour pictures with even illumination. Low light requirement due to very high light sensitivity (0.1 lux). Fixed focus and special lens with 90° wide angle, also for detecting the smallest details.

Exchangeable cable camera sets

Camera cable sets S-Color, consisting of special high-resolution colour camera with optional **30 m push cable Ø 5.4 mm**, flexible, for Ø 50–150 mm, in hasp with electronic metre counter, **20 m push cable Ø 4.5 mm**, very flexible, for small pipe diameters and narrower bends Ø (40) 50–150 mm, in the hasp with electronic metre counter or **10 m push cable Ø 4.5 mm** with length mark, very flexible, for small pipe diameters and narrower pipe bends Ø (40) 50–150 mm, in the cable reel, with connection for controller unit. Very small, rounded camera head Ø 25 mm, water-tight up to 20 m (0.2 MPa/2 bar/29 psi) and highly flexible sliding spring tapered towards the push cable for effortless feeding even through several pipe bends. Camera head with strong, quick-change protective cap with inserted mineral glass pane. Bend-maneuvring push cable in hybrid technology, with glass fibre core, data cables and plastic sheath, very stable, for long life. Robust, powder-coated, easy to clean cable cage. Hasp with rotary cage for simple unwinding and winding of the push cable and integrated sensor for electronic metering. Carrying case for camera cable set as an accessory.

Guide bodies

Various guide bodies for larger pipe diameters, firmly lockable on the camera head, as an accessory.



Info

Supply format

REMS CamSys Set S-Color. Electronic camera inspection system for low-cost inspection and damage analysis. Documentation of pictures and videos on SD card with specification of date and time. Controller unit in microprocessor technology with 3.5" TFT-LCD colour display, SD card slot, USB port, video out socket PAL/NTSC, integrated Li-Polymer battery, 3.7 V, 4.0 Ah, in sturdy, impact-proof plastic housing, spray protected. 2 m connecting cable from the controller unit to the camera cable set, voltage supply/charger 100–240 V, 50–60 Hz, 15 W, SD card 4 GB, USB cable, in sturdy case. Camera cable set S-Color with high resolution special colour camera Ø 25 mm with CMOS image sensor and push cable.

Description	Version	Art.-No.	
Set S-Color 10 K	10 m push cable Ø 4.5 mm with length mark, very flexible, in cable reel. For small pipe diameters and narrower pipe bends Ø (40) 50–150 mm, drains, shafts, stacks and other cavities.	175008	
Set S-Color 20 H	20 m push cable Ø 4.5 mm, very flexible, in the hasp with electronic metre counter. For small pipe diameters and narrower pipe bends Ø (40) 50–150 mm, drains, shafts, stacks and other cavities.	175007	
Set S-Color 30 H	30 m push cable Ø 5.4 mm, flexible, in the hasp with electronic metre counter. For pipes Ø 50–150 mm, drains, shafts, stacks and other cavities.	175010	



Accessories

Description	Art.-No.	
REMS CamSys Basic-Pack. Controller unit in microprocessor technology with 3.5" TFT-LCD colour display, SD card slot, USB port, video out socket PAL/NTSC, integrated Li-Polymer battery, 3.7 V, 4.0 Ah, in sturdy, impact-proof plastic housing, spray protected. 2 m connecting cable from the controller unit to the camera cable set, voltage supply/charger 100–240 V, 50–60 Hz, 15 W, SD card 4 GB, USB cable, in sturdy case.	175000	
Camera cable set S-Color 10 K with high resolution special colour camera Ø 25 mm with CMOS image sensor, 10 m push cable Ø 4.5 mm with length marking, very flexible, with connection for controller unit, in cable reel. For small diameters and narrower pipe bends Ø (40) 50–150 mm.	175305	
Camera cable set S-Color 20 H with high resolution special colour camera Ø 25 mm with CMOS image sensor and 20 m push cable Ø 4.5 mm, flexible, in the hasp with electronic metering and connection for controller unit. For small diameters and narrower pipe bends Ø (40) 50–150 mm.	175306	
Camera cable set S-Color 30 H with high resolution special colour camera Ø 25 mm with CMOS image sensor and 30 m push cable Ø 5.4 mm, flexible, in the hasp with electronic metering and connection for controller unit. For Ø 50–150 mm.	175011	
Guide body Ø 62 mm S-Color/S-Color S, for camera cable set S-Color/S-Color S	175057	
Guide body Ø 100 mm S-Color/S-Color S, for camera cable set S-Color/S-Color S	175058	
Protective cap S-Color/S-Color S with mineral glass pane, sealing ring, for camera cable set S-Color/S-Color S	175026	
Carrying case for camera cable set	175123	
Case with inlay	175018	



Mobile, handy camera inspection system for inexpensive inspection and damage analysis of pipes, drains, chimneys and other hollow cavities. Self-levelling camera. Transmitter for localising camera heads. Electronic metering. Also for inspection after pipe cleaning work and for acceptance of new installations or repairs. Documentation of pictures and videos with voice recording on SD card. For battery and corded operation.

Camera head S-Color/S-Color S	Ø 25 mm
Camera head S-Color S-N	Ø 33 mm
Pipes, drains, chimneys, other cavities	
Camera head S-Color	Ø (40) 50 – 150 mm
Camera head S-Color S	Ø 50 – 150 mm
Camera head S-Color S-N	Ø 70 – 150 mm

REMS CamSys 2 – Brilliant pictures and videos of pipes and drains. Voice recording Self-levelling camera. Transmitter for localising camera heads. SD card slot. Electronic metering. Cordless and mains operation.

System advantage

Only **one** controller unit with TFT-LCD colour display for connecting different camera cable sets for different requirements. Therefore inexpensive conversion possible.

Design

Mobile, handy, light. Can be used everywhere, even in very narrow places. Controller unit connected to the camera cable set by a 2 m connecting cable, removable for easy cleaning of the camera cable set. Various camera cable sets can be used. Plug-screw connections for changing the camera cable sets and the controller unit without tools. Sturdy case for controller unit, voltage supply/charger and accessories.

Controller unit with TFT-LCD colour display

Controller unit with 7" colour display with state of the art TFT-LCD technology for brilliant pictures and videos, 178 mm screen diagonal, 720 x 480 pixels. Very light and handy, only 1.3 kg. Sturdy, impact-proof plastic housing, spray protected, glare protection. Integrated stand for different angles of inclination of the screen. Ergonomic grips with soft-grip and adjustable clamping bands, keys for picture and video, for one-hand operation by right and left handers. Small dimensions: 270 x 164 x 70 mm. Keys for setting the brightness of the LEDs of the colour camera head. Full screen, 2x zoom, 4x rotation options for the picture. Adjustable automatic switch-off. SD card slot. Pictures and videos with voice recording can be saved on an SD card for simple documentation of the inspection result. Insertion depth of the camera is stored in the picture and the video, optionally also date and time of the recording. Pictures can be taken during video recording without impairing the video recording. Immediate playback of saved recordings or transmission to other devices with SD card. Pictures can also be taken later from the video during playback of recorded videos on the controller's colour display. USB connector for direct connection to PC or laptop. Video output socket Composite-Video PAL/NTSC for connecting an external monitor. Connection for voltage supply/charger 100 – 240 V.

Cordless and mains operation

Li-Polymer Technology. Controller unit with integrated Li-Polymer battery 3.7V, 7.6 Ah. Light and powerful. Power supply/charger 100 – 240 V, 15 W, with USB port and USB cable for connecting power supply/charger, laptop or other voltage supply. No memory effect for maximum battery performance.

High resolution special colour camera

High resolution special colour camera with CMOS image sensor and ultra bright, white light emitting diodes (LEDs) with adjustable light intensity up to 1700 mcd and concentrated radiation angle for brilliant colour pictures with evenly bright illumination. Low light requirement due to very high light sensitivity (0.1 lux). Fixed focus and special lens with 90° wide angle, also for detecting the smallest details.



Info

Exchangeable cable camera sets

Camera cable set S-Color, consisting of a special high resolution colour camera Ø 25 mm with 20 m push cable Ø 4.5 mm, very flexible, for small pipe diameters and narrower bends Ø (40) 50 – 150 mm, in the hasp with electronic metering or 10 m push cable Ø 4.5 mm with length mark, very flexible, for small pipe diameters and narrower pipe bends Ø (40) 50 – 150 mm, in the cable reel. **Camera cable set S-Color S**, consisting of a special high resolution colour camera Ø 25 mm with 30 m push cable Ø 5.4 mm, flexible, for Ø 50 – 150 mm, in the hasp with electronic metering and 33 kHz transmitter for localising the camera head. **Camera cable set S-Color S-N**, consisting of a special high resolution colour camera Ø 33 mm with 30 m push cable Ø 5.4 mm, flexible, for Ø 70 – 150 mm, in the hasp with electronic metering, 33 kHz transmitter for localising the camera head and self-levelling camera for upright pictures and videos. Connection for controller unit. Very small, rounded camera head, water-proof up to 20 m (0.2 MPa/2 bar/29 psi) and highly flexible sliding spring tapered towards the push cable for effortless feeding even through several pipe bends. Camera head with strong, quick-change protective cap with inserted mineral glass pane. Bend-manoeuvring push cable in hybrid technology, with glass fibre core, data cables and plastic sheath, very stable, for long life. Robust, powder-coated, easy to clean cable cage. Hasp with rotary cage for simple unwinding and winding of the push cable and integrated sensor for electronic metering. Carrying case for camera cable set as an accessory.

Guide bodies

Guide body S-Color/S-Color S and S-Color S-N Ø 62 mm and Ø 100 mm, for greater pipe diameters, can be locked to camera head S-Color/S-Color S or S-Color S-N, as an accessory.

Tracker

REMS Explorer for localising a camera head with a 33 kHz transmitter, for determining the position of damages or the course of a pipe, as an accessory.



Supply format

REMS CamSys 2 Set S-Color. Electronic camera inspection system for low-cost inspection and damage analysis. Documentation of pictures and videos with voice recording on SD card with specification of date and time. Controller unit in microprocessor technology with 7" TFT-LCD colour display, SD card slot, USB port, video out socket PAL/NTSC, integrated Li-Polymer battery 3.7V, 7.6 Ah, in sturdy, impact-proof plastic housing, spray protected, glare protection, stand. 2 m connecting cable from the controller unit to the camera cable set, voltage supply/charger 100 – 240V, 50 – 60 Hz, 15 W, SD card 4 GB, USB cable, video cable, in sturdy case. Camera cable set S-Color with high resolution special colour camera with CMOS image sensor and push cable.

Description	Version	Art.-No.	
Set S-Color 10 K	High resolution special colour camera Ø 25 mm, 10 m push cable Ø 4.5 mm with length mark, very flexible, in the cable reel. For small pipe diameters and narrower pipe bends Ø (40) 50 – 150 mm, drains, shafts, stacks and other cavities.	175301	
Set S-Color 20 H	High resolution special colour camera Ø 25 mm, 20 m push cable Ø 4.5 mm, very flexible, in the hasp with electronic metering. For small pipe diameters and narrower pipe bends Ø (40) 50 – 150 mm, drains, shafts, stacks and other cavities.	175302	
Set S-Color S 30 H	High resolution special colour camera Ø 25 mm, 33 kHz transmitter for localising the camera head, 30 m push cable Ø 5.4 mm, flexible, in the hasp with electronic metering. For pipes Ø 50 – 150 mm, drains, shafts, stacks and other cavities.	175303	
Set S-Color S-N 30 H	High resolution special colour camera Ø 33 mm, self-levelling, 33 kHz transmitter for localising the camera head, 30 m push cable Ø 5.4 mm, flexible, in the hasp with electronic metering. For pipes Ø 70 – 150 mm, drains, shafts, stacks and other cavities.	175304	



Description	Art.-No.	
REMS CamSys 2 Basic-Pack Controller unit in microprocessor technology with 7" TFT-LCD colour display, SD card slot, USB port, video out socket PAL/NTSC, integrated Li-Polymer battery, 3.7 V, 7.6 Ah, in sturdy, impact-proof plastic housing, glare protection, stand, spray protected. 2 m connecting cable from the controller unit to the camera cable set, voltage supply/charger 100–240 V, 50–60 Hz, 15 W, SD card 4 GB, USB cable, video cable, in sturdy case.	175300	
Camera cable set S-Color 10 K High resolution special colour camera Ø 25 mm, 10 m push cable Ø 4.5 mm with length mark, very flexible, in the cable reel. For small diameters and narrower pipe bends Ø (40) 50–150 mm.	175305	
Camera cable set S-Color 20 H High resolution special colour camera Ø 25 mm, 20 m push cable Ø 4.5 mm, very flexible, in the hasp with electronic metering. For small diameters and narrower pipe bends Ø (40) 50–150 mm.	175306	
Camera cable set S-Color S 30 H High resolution special colour camera Ø 25 mm, 33 kHz transmitter for localising the camera head, 30 m push cable Ø 5.4 mm, flexible, in the hasp with electronic metering. For Ø 50–150 mm.	175307	
Camera cable set S-Color S-N 30 H High resolution special colour camera Ø 33 mm, self-levelling, 33 kHz transmitter for localising the camera head, 30 m push cable Ø 5.4 mm, flexible, in the hasp with electronic metering. For Ø 70–150 mm.	175308	
Guide body Ø 62 mm S-Color/S-Color S, for camera head S-Color/S-Color S	175057	
Guide body Ø 100 mm S-Color/S-Color S, for camera head S-Color/S-Color S	175058	
Guide body Ø 62 mm S-Color S-N, for camera head S-Color S-N	175343	
Guide body Ø 100 mm S-Color S-N, for camera head S-Color S-N	175339	
Protective cap S-Color/S-Color S with mineral glass pane, sealing ring, for camera head S-Color/S-Color S	175026	
Protective cap S-Color S-N with mineral glass pane, sealing ring, for camera head S-Color S-N	175330	
REMS Explorer, tracker for localising a camera head with a 33 kHz transmitter	175312	
Carrying case for camera cable set	175123	
Case with inlay	175323	





REMS
Explorer

REMS CamSys2

REMS CamSys2

REMS Pull-Push

Suction and pressure cleaning device

Proven, reliable suction and pressure cleaning device for fast clearance of blockages.

REMS Pull-Push – fast clearance of blockages.

High pressing force by front, adjustable handle.

Optimum adaptation to the cleaning task by 2 sleeves:

Short sleeve for wash basins and baths, long sleeve for toilets.



Info



Supply format

REMS Pull-Push. Suction and pressure cleaning device for fast clearance of blockages. With short and long sleeve. In a box.

	Art.-No.	
	170300	

REMS Mini-Cobra

Drain cleaner for manual and electric operation

Proven, handy device for the fast unblocking of pipes, e.g. for kitchens, bathrooms and toilets.

For pipes \varnothing 20 – 50 (75) mm

For drain cleaning cables \varnothing 6, 8, 10 mm

REMS Mini-Cobra – by hand or electric. Indispensable to remove small blockages.

Design

Simple, robust, practical design. Handy, light. Only 2.9 kg. Easy operation also in traps and tight bends. Easy insertion of cable directly through strainers in sinks and drains. Locking of cable by quick-action chuck.

Drain cleaning cables

Cables in high quality spring steel. Specially hardened. Highly flexible for effortless feed-forward in tight bends. Cable end with bulbous head (sink strainer head), thus easy to bend.

Cable drum

In hot-galvanized spring steel. Specially hardened. Highly flexible for effortless feed-forward in tight pipe bends. Cable end with bulbous head. Corrosion-resistant cable drum in shock-proof, glass-fibre reinforced plastic prevents pollution of the environment. Ventilation of the cable drum interior enables self-drying of cable. View to cable at all times.

Drive

By hand with easy action, easy grip crank handle or with suitable electric drill/ with suitable electric screwdriver, speed \leq 300 rpm. Hexagon adapter for electric drive located in the drum cover.



German Quality Product



Info



Supply format

REMS Mini-Cobra. Pipe cleaning device for pipes \varnothing 20 – 50 (75) mm, with crank handle and hexagonal driver for electric drill/screwdriver. For drain cleaning cables \varnothing 6, 8 and 10 mm. Cable drum in shock-proof, glass-fibre reinforced plastic. Quick-action chuck. Cable \varnothing 8 mm \times 7.5 m long. In a carton.

	Art.-No.	
	170010	

Accessories

Description	\varnothing \times Length	Art.-No.
Drain cleaning cable	8 mm \times 7.5 m	170200
	10 mm \times 10 m	170205
Drain cleaning cable with core	8 mm \times 7.5 m	170201



Electric pipe cleaning device with fast switchover.
For effortless and quick application to remove pipe blockages in kitchen, bath, toilet.

For pipes \varnothing 20 – 50 (75) mm
For drain cleaning cables \varnothing 8, 10 mm

REMS Mini-Cobra S – Fast clearance of pipe blockages. Ultra fast reversal of direction of spiral feed/return by fast switchover.

Design

Compact unit of drive machine and cable drum. Handy, light. Only 5.7 kg. Combined thrust and grip handle for controlling the automatic feed-forward and reverse and for safe holding of the unit. Easy operation also in traps and tight bends.

Fast switchover

For easy operation and fast clearance of pipe blockages. Ultra fast reversal of direction of spiral feed/return by fast switchover (**Patent EP 3 059 022**) also under full load without changing the motor's direction of rotation, avoids looping of the drain cleaning cables when suddenly encountering resistance from pipe blockages, for long life of the drain cleaning cables.

Drain cleaning cables

Drain cleaning cables in high quality spring steel. Specially hardened. Highly flexible for effortless feed-forward in tight pipe bends. Cable end with bulbous head (sink strainer head), thus easy to bend. Drain cleaning cables with core in high quality spring steel prevents ingress of dirt and generation of long fibres in the cable windings.

Cable drum

Corrosion resistant cable drum in shock-proof, glass-fibre reinforced plastic prevents pollution of the environment. Ventilation of the cable drum interior enables self-drying of cable. View of the cable at any time.

Drive

Proven drive unit with hexagon mount. Enormously powerful. Robust, maintenance-free gear with safety slipping clutch. Universal motor, 630 W, high-torque forward and reverse at low speed. Stepless, electronic speed control. The speed between 0 and 950 rpm is controlled by pressing the tip switch steplessly (acceleration switch).



German Quality Product



Patent EP 3 059 022

Supply format

REMS Mini-Cobra S. Electric pipe cleaning device with fast switchover, for pipes \varnothing 20 – 50 (75) mm. For drain cleaning cables \varnothing 8 and 10 mm. Drive unit with maintenance-free gear, universal motor 230 V or 110 V, 50 – 60 Hz, 630 W, high-torque forward and reverse at low speed. Safety tip switch. Stepless, electronic speed control (acceleration switch) between 0 and 950 rpm. Cable drum in shock-proof, glass-fibre reinforced plastic. Cable \varnothing 8 mm, with core, 7.5 m long.

Description	Art.-No.
REMS Mini-Cobra S , in a carton	170022
REMS Mini-Cobra S Set , in sturdy steel case.	170023



Accessories

Description	\varnothing × Length	Art.-No.
Drain cleaning cable with core	8 mm × 7.5 m	170201
Drain cleaning cable	10 mm × 10 m	170205
Steel case		185058



Mobile, handy, cordless pipe cleaning device with fast switchover. For effortless and quick application to remove pipe blockages in kitchen, bath, toilet. Li-Ion 22V Technology. For battery and corded operation.

For pipes	Ø 20 – 50 (75) mm
For drain cleaning cables	Ø 8, 10 mm

REMS Mini-Cobra S 22V VE – fast clearance of pipe blockages anywhere. Ultra fast reversal of direction of spiral feed/return by fast switchover. With powerful, brushless battery motor.

Design

Compact unit of cordless drive unit and spiral drum. Mobile, handy, light. Complete with battery pack only 5.2 kg. Combined thrust and grip handle for controlling the automatic feed-forward and reverse and for safe holding of the unit. Easy operation also in traps and tight bends. Integrated LED work light for illuminating the work place.

Fast switchover

For easy operation and fast clearance of pipe blockages. Ultra fast reversal of direction of spiral feed/return by fast switchover (**Patent EP 3 059 022**) also under full load without changing the motor's direction of rotation, avoids looping of the drain cleaning cables when suddenly encountering resistance from pipe blockages, for long life of the drain cleaning cables.

Drain cleaning cables

Drain cleaning cables in high quality spring steel. Specially hardened. Highly flexible for effortless feed-forward in tight pipe bends. Cable end with bulbous head (sink strainer head), thus easy to bend. Drain cleaning cables with core in high quality spring steel prevents ingress of dirt and generation of long fibres in the cable windings.

Cable drum

Corrosion resistant cable drum in shock-proof, glass-fibre reinforced plastic prevents pollution of the environment. Ventilation of the cable drum interior enables self-drying of cable. View of the cable at any time.

Drive

High-performance electro-mechanical drive with powerful, brushless motor 21.6V, 500 W output, extra torque powerful left and right hand rotation at specially adapted speed, robust, precision ball bearing-mounted gear, maintenance-free. Safety switch, electronically controlled for jolt-free switching on and off. Continuous, electronic speed control. The speed can be continuously controlled by variable pressure on the safety switch from 0 to 560 rpm (accelerator switch /VE).

Battery or mains operation

Li-Ion 22V Technology. Highly resistant Li-Ion 21.6V battery with 1.5, 4.4, 5.0 or 9.0Ah capacity, for long service life. Light and powerful. Graduated charging status check by coloured LEDs. Operating temperature range – 10 to + 60 °C. No memory effect for maximum battery power. Rapid charger 100–240V, 90W. Rapid charger 100–240V, 290W, for shorter charging times, as accessory. 220–240V/21.6V, 15A output, voltage supply for mains operation instead of Li-Ion battery 21.6V, as accessory.



German Quality Product



Info



Patent EP 3 059 022



Supply format

REMS Mini-Cobra S 22 V VE. Cordless pipe cleaning device with fast switchover, for pipes \varnothing 20–50 (75) mm. For drain cleaning cables \varnothing 8 and 10 mm. Drive unit with powerful, brushless battery motor 21.6 V, 500 W, maintenance-free, robust gear, extra torque powerful left and right hand rotation at low speeds, safety switch. Continuous, electronic speed control (accelerator switch (VE)) from 0 to 560 rpm. Battery Li-Ion 21.6 V, 2.5 Ah, rapid charger 220–240 V, 50–60 Hz, 70 W. Cable drum in shock-proof, glass-fibre reinforced plastic. Cable \varnothing 8 mm, with core, 7.5 m long.

Description	Art.-No.
REMS Mini-Cobra S 22 V VE, in a carton	170025
REMS Mini-Cobra S 22 V VE Set, in sturdy steel case	170026

Other voltages on request.

Accessories

Description	$\varnothing \times$ Length	Art.-No.
Drain cleaning cable with core	8 mm \times 7.5 m	170201
Drain cleaning cable	10 mm \times 10 m	170205
Battery Li-Ion 21.6 V, 2.5 Ah		571571
Battery Li-Ion 21.6 V, 4.4 Ah		571574
Battery Li-Ion 21.6 V, 5.0 Ah		571581
Battery Li-Ion 21.6 V, 9.0 Ah		571583
Rapid charger 100–240 V, 50–60 Hz, 90 W		571585
Rapid charger 100–240 V, 50–60 Hz, 290 W		571587
Voltage supply 220–240 V/21.6 V, 50–60 Hz, 15 A, for mains operation instead of battery Li-Ion 21.6 V.		571567
Steel case with inlay		170107

REMS Lumen 2800 22V, cordless LED flood light, see page 111



Handy, robust, compact machines for versatile use in pipe and drain cleaning. High-speed rotator with connectable cable sections. Proven technology.

For pipes	Ø 20 – 250 mm
For pipe and drain cleaning cables	Ø 8, 16, 22, 32 mm

All pipe and drain cleaning cables and tools can also be used for other makes.

REMS Cobra – clear pipe – easy and fast.
High-speed rotator with cable sections for work length up to 100 m. Effective chain knocking and milling up to 740 rpm. Closed drive spindle protects motor and drive against dirt and water.

High speed rotator with connectable cable sections
 High-speed rotator, 740 rpm (REMS Cobra 22) resp. 520 rpm (REMS Cobra 32), with cable sections for effective fast operation, e.g. during chain knocking or milling. Under difficult conditions also, e.g. roots and hard incrustations. Cable sections to be connected as needed up to 70 m (REMS Cobra 22) resp. 100 m (REMS Cobra 32) work length. No unnecessary rotating of long pipe and drain cleaning cables.

Design

Robust, practical, splash-proof. Maintenance-free. Small in size. Favourable weight, drive unit REMS Cobra 22 only 19 kg, drive unit REMS Cobra 32 only 24 kg. Machine frame made of distortion-free cast aluminium with protective covers in shock-proof plastic material. REMS Cobra 22 with holders for part spirals 16 and 22 for fixing the part spirals to the machine frame when changing spirals. Chucking system which is located outside the machine housing with straight through undivided drive spindle for the pipe and drain cleaning cable. This enables a complete seal of the machine interior against dirt and water. Connecting cable with integrated personal protection switch (PRCD). Guide hose prevents excess rotation of pipe and drain cleaning cables and pollution of the environment. Legs with rubber caps guarantee a safe, floor-protecting stand.

High-performance pipe and drain cleaning cables
 Specially hardened. Highly flexible for effortless feed-forward in tight pipe bends. Rapid action coupling for fast extension and shortening. T-groove coupling with safety lock through spring-loaded thrust pin. Manual feed-forward for sensitive operation. Standard pipe and drain cleaning cable for universal pipe and drain cleaning jobs, highly flexible, specially suited for tight or several consecutive pipe bends. Pipe and drain cleaning cable S with thicker special spring steel for very difficult to remove obstructions, e.g. root cutting. Drain cleaning cables with weather-proof and temperature resistant plastic core prevents drain cleaning cable from dirt and generation of long fibres in the cable windings. Drive through REMS Cobra 22, REMS Cobra 32 or drive machines of other makes.

Clamping jaws for cable drive

Clamping jaws in high-grade hardened steel, resistant to wear and precise fit. Instant and exact clamping and opening of pipe and drain cleaning cables allow optimum control, power transmission and operating safety. REMS Cobra 22: Choice of pipe and drain cleaning cables Ø 16 mm and 22 mm, without changing the clamping jaws. Pipe and drain cleaning cable Ø 8 mm with adapter drum 22/8 and integrated clamping jaws, as accessory. REMS Cobra 32: Choice of drain cleaning cables Ø 22 and 32 mm, without changing the clamping jaws. Drain cleaning cables Ø 16 mm with clamping jaws 16, as accessory. Pipe and drain cleaning cable Ø 8 mm with adapter drum 32/8 and integrated clamping jaws, as accessory.

Drive

Powerful, quiet running capacitor motor with high torque, 750 W (REMS Cobra 22), 1050 W (REMS Cobra 32), right and left-hand rotation. Full transmission of motor power by a slipping-proof maintenance-free toothed belt drive. Straight through closed drive spindle. Permanently lubricated, maintenance-free roller bearings. Fast and secure run and stop of pipe and drain cleaning cable through strong, centrally located pressing lever provides central power input. Lever doubles as a carrying device without awkward locking.

Pipe and drain cleaning tools

Large variety of pipe and drain cleaning tools (page 286 – 287), also fit into pipe and drain cleaning machines of other makes.



German Quality Product

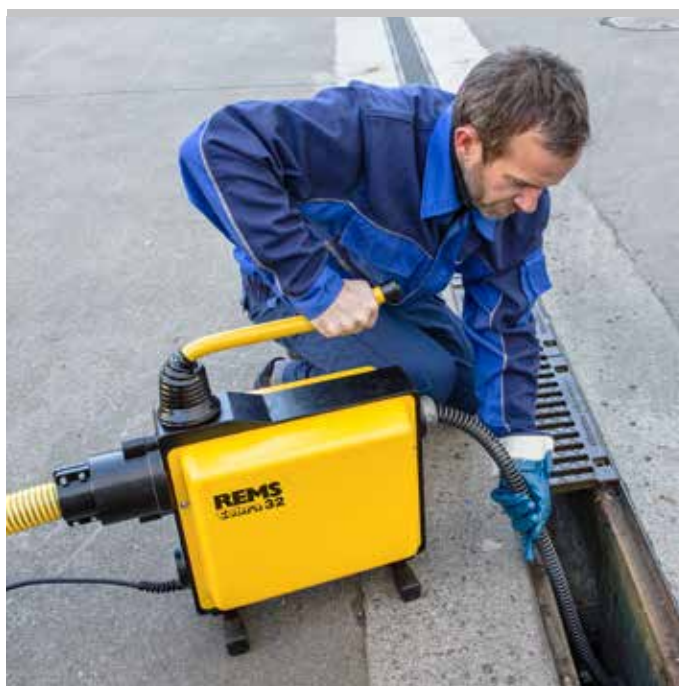

German Quality Product



Straight through closed drive spindle protects motor and drive against dirt and water.

Supply format

REMS Cobra 22 Set. Electric pipe and drain cleaning machine for pipes Ø 20–150 mm. Drive unit with maintenance-free belt drive, capacitor motor 230 V, 50 Hz, 750 W, right and left-hand rotation, guide hose. Personal protection switch (PRCD). Choice of cable and tool set 16 or/and 22. In a carton.

Description	Version	Art.-No.
Set 16	5 cable sections 16 × 2.3 m in cable carrier, straight auger 16, bulbous auger 16, toothed blade borer 16/25, cable joint separator, 1 pair of guide gloves, steel case for tool set	172010
Set 22	5 cable sections 22 × 4.5 m in cable carrier, straight auger 22, retrieving auger 22, funnel auger 22, toothed cross-blade borer 22/35, cable joint separator 22/32, 1 pair of guide gloves, steel case for tool set	172011
Set 16 + 22	5 cable sections 16 × 2.3 m in cable carrier, straight auger 16, bulbous auger 16, toothed blade borer 16/25, cable joint separator, 5 cable sections 22 × 4.5 m in cable carrier, straight auger 22, retrieving auger 22, funnel auger 22, toothed cross-blade borer 22/35, cable joint separator 22/32, 2 pairs of guide gloves, steel case for each tool set	172012



Info

Supply format

REMS Cobra 32 Set. Electric pipe and drain cleaning machine for pipes Ø 20–250 mm (½–10"). Drive unit with maintenance-free belt drive, capacitor motor 230 V, 50 Hz, 1050 W, right and left-hand rotation, guide hose. Personal protection switch (PRCD). Choice of cable and tool set 32 or cable and tool sets 22 and 32 or 16 and 22. In a carton.

Description	Version	Art.-No.
Set 32	4 cable sections 32 × 4.5 m in cable carrier, straight auger 32, retrieving auger 32, funnel auger 22, toothed cross-blade borer 32/45, cable joint separator 22/32, 1 pair of guide gloves, case for tool set	174010
Set 22 + 32	5 cable sections 22 × 4.5 m in cable carrier, straight auger 22, retrieving auger 22, funnel auger 22, toothed cross-blade borer 22/35, cable joint separator 22/32, 4 cable sections 32 × 4.5 m in cable carrier, straight auger 32, retrieving auger 32, funnel auger 32, toothed cross-blade borer 32/45, cable joint separator 22/32. 2 pairs of guide gloves, steel case/case for each tool set	174011
Set 16 + 22	5 cable sections 16 × 2.3 m in cable carrier, 2 clamping jaws 16, straight auger 16, bulbous auger 16, toothed blade borer 16/25, cable joint separator 16, 5 cable sections 22 × 4.5 m in cable carrier, straight auger 22, retrieving auger 22, funnel auger 22, toothed cross-blade borer 22/35, cable joint separator 22/32, 2 pairs of guide gloves, steel case for each tool set	174012



Info

Accessories

Description	Art.-No.
REMS Cobra 22 drive unit with guide hose	172000
REMS Cobra 32 drive unit with guide hose	174000

Pipe and drain cleaning tools see page 286–287.



Description	Size	Art.-No.
Cable and tool set 16 consisting of 5 cable sections 16 × 2.3 m in cable carrier, straight auger 16, bulbous auger 16, toothed blade borer 16/25, cable joint separator, 1 pair of guide gloves, steel case for tool set		172050
Cable and tool set 22 consisting of 5 cable sections 22 × 4.5 m in cable carrier, straight auger 22, retrieving auger 22, funnel auger 22, toothed cross-blade borer 22/35, cable joint separator, 1 pair of guide gloves, steel case for tool set		172051
Cable and tool set 32 consisting of 4 cable sections 32 × 4.5 m in cable carrier, straight auger 32, retrieving auger 32, funnel auger 32, toothed cross-blade borer 32/45, cable joint separator 22/32, 1 pair of guide gloves, case for tool set		174050
Adapter drum REMS Cobra 22/8 with cable Ø 8 mm × 7.5 m long, with bulbous head		170011
Adapter drum REMS Cobra 32/8 with cable Ø 8 mm × 7.5 m long, with bulbous head		170012
Clamping jaws 16 (pack of 2) for REMS Cobra 32 for clamping drain cleaning cables Ø 16 mm		174101
Pipe and drain cleaning cable for pipe-Ø 10–50 (75) mm	8 × 7.5 m	170200
for pipe-Ø 25–125 mm	16 × 2.3 m	171200
for pipe-Ø 50–150 mm	22 × 4.5 m	172200
for pipe-Ø 50–250 mm	32 × 4.5 m	174200
Pipe and drain cleaning cable (5 pieces) in cable carrier for pipe-Ø 25–125 mm	16 × 2.3 m	171201
Pipe and drain cleaning cable (5 pieces) in cable carrier for pipe-Ø 50–150 mm	22 × 4.5 m	172201
Pipe and drain cleaning cable (4 pieces) in cable carrier for pipe-Ø 50–250 mm	32 × 4.5 m	174201
Pipe and drain cleaning cable S With thick special spring steel for high stability, e.g. during root cutting, milling, chain knocking for pipe-Ø 25–125 mm	16 × 2 m	171205
for pipe-Ø 50–150 mm	22 × 4 m	172205
for pipe-Ø 50–250 mm	32 × 4 m	174205
Pipe and drain cleaning cable with core prevents clogging of pipe and drain cleaning cable with dirt for pipe-Ø 25–125 mm	16 × 2.3 m	171210
for pipe-Ø 50–150 mm	22 × 4.5 m	172210
for pipe-Ø 50–250 mm	32 × 4.5 m	174210
Pipe and drain cleaning cable with core (5 pieces) in cable carrier for pipe-Ø 50–150 mm	22 × 4.5 m	172203
Pipe and drain cleaning cable with core (4 pieces) in cable carrier for pipe-Ø 50–250 mm	32 × 4.5 m	174203
Cable reduction 22/16 for connecting individual cables of different sizes	22/16	172154
Cable reduction 32/22 for connecting individual cables of different sizes	32/22	174154
Cable carrier (empty)	16 22 32	171150 172150 174150
Cable joint separator for releasing the safety lock	16 22/32	171151 172151



Description	Size	Art.-No.
Straight auger for exploring the obstruction to withdraw a sample. Clearing of solid blockages caused by e.g. textiles, paper, kitchen waste	16 22 32	171250 172250 174250
Bulbous auger for minor obstructions caused by textiles and papers. Flexible, facilitates advancement in tight bends.	16 22 32	171265 172265 174265
Funnel auger for textile and paper obstructions in particular. Especially useful for cleaning larger diameter pipes. Also be used as a recovery tool for cables left in the pipe.	16 22 32	171270 172270 174270
Retrieving auger with extended, specially angled grappling arms. Used to recover cables left in the pipe. Not suitable for boring operations.	16 22 32	171275 172275 174275
Serrated blade borer for boring out greasy or heavily silted pipes, e.g. drains of washing machines, dishwashers. Riveted to the connector (not soldered or welded), so as to prevent any deformation of the hardened spring steel blades.	16/25 22/35 22/45 32/55	171280 172280 172281 174282
Serrated cross-blade borer Universal use for obstructions of all kinds, including incrustations, e.g. limescale deposits on the inside of the pipe. Riveted to the connector (not soldered or welded), so as to prevent any deformation of the hardened spring steel blades. Operation with pipe and drain cleaning cable S recommended.	16/25 16/35 22/35 22/45 22/65 32/45 32/65 32/90 32/115	171290 171291 172290 172291 172293 174291 174293 174295 174296
Forked cutter to remove moderate to severe silting or persistent grease contamination. Made of hardened spring steel.	16	171305
Cross-forked cutter to remove moderate to severe silting or persistent grease contamination. Made of hardened spring steel. Operation with pipe and drain cleaning cable S recommended.	16	171306
Serrated forked cutter Versatile use, e.g. for removal of slurries and for mincing (crushing) of root infested pipe. Made of hardened spring steel.	22/65 32/65 32/90	172305 174305 174306
Root cutter specially designed for root infested pipe. Hardened, replaceable ring-type saw, cutting to front and rear. Operation with pipe and drain cleaning cable S recommended.	22/65 32/65 32/90	172310 174310 174311
Chain knocker, smooth rings for final pipe and drain cleaning for removal of grease deposits and incrustations, e.g. limescale deposits on the inside of the pipe. For sensitive pipes, e.g. plastic.	16 22 32	171340 172340 174340
Chain knocker, spiked links for final pipe and drain cleaning for removal of grease deposits and incrustations, e.g. limescale deposits on the inside of the pipe. For cast and concrete pipes.	16 22 32	171341 172341 174341
Guide gloves, pair for secure gripping and guiding of pipe and drain cleaning cables		172610
Riveted guide glove, left Riveted guide glove, right for secure gripping and guiding of pipe and drain cleaning cables. Fully leather, inner surface riveted.		172611 172612



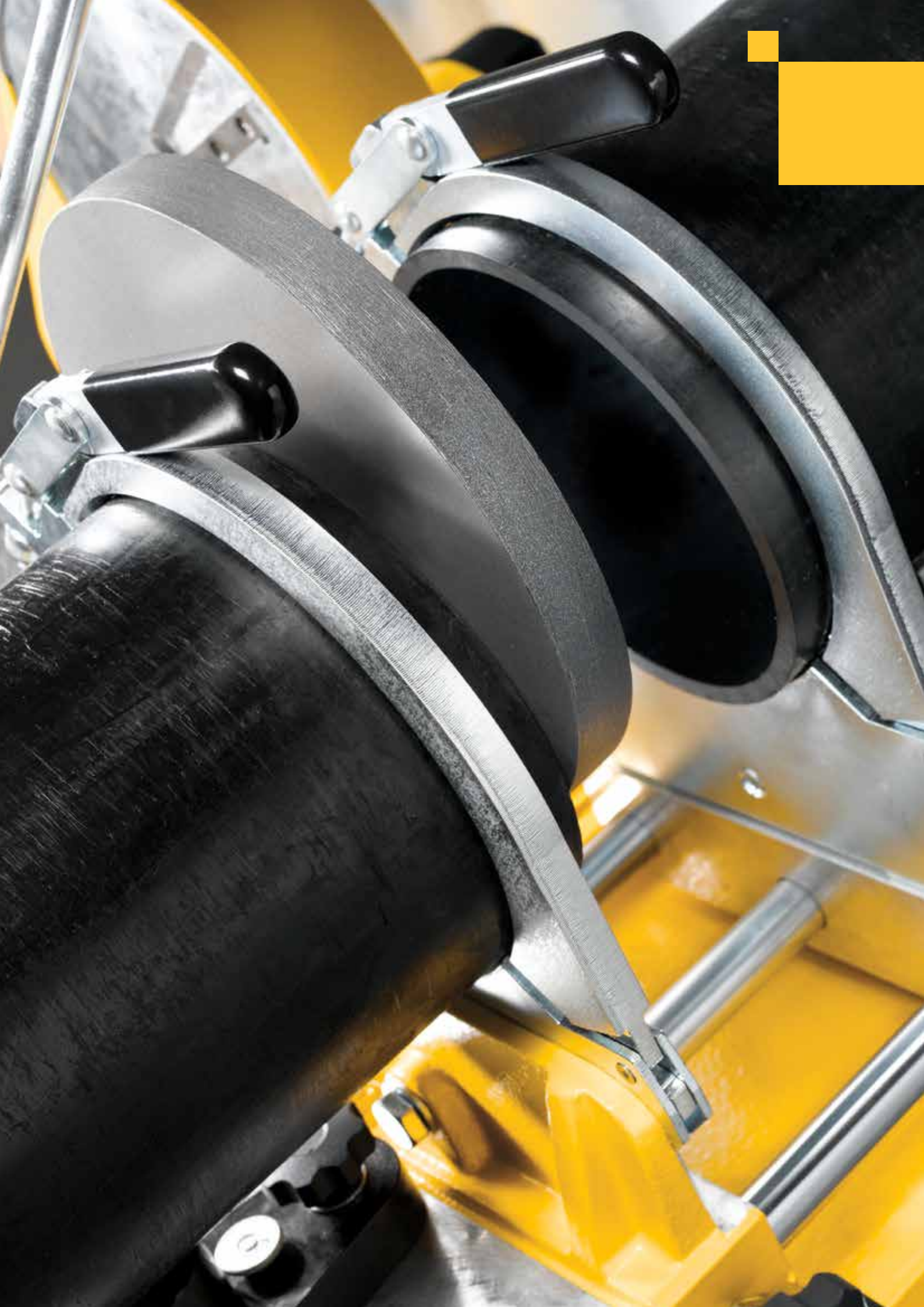

Plastic Pipe Welding



Electric sleeve welding unit

290



Sleeve welding units

291



Butt welding machines

292



Butt welding units

296

Powerful, handy unit for welding plastic drain pipes with electric sleeves in PE.

Plastic pipes and electric sleeves in PE Ø 40 – 160 mm

For Geberit, Akatherm-Euro, Coes, Valsir, Waviduo

REMS EMSG 160 – automatic welding.
Electronic control. Acoustic and visual monitoring of welding process.

Smallest sizes. Super-handy, light, only 0.7 kg. Can be used anywhere.

Electronic control with micro controller for automatic adjustment of welding current (welding temperature) and welding time according to sleeve size.

Automatic compensation of welding time in accordance with the ambient temperature.

Acoustic and visual monitoring of welding process.

Wide work radius through extra-long cables.

Sturdy, shock-proof plastic casing with carrying strap. Splash-proof.



German Quality Product



Info

Supply format

REMS EMSG 160. Electric sleeve welding unit 230 V, 50 Hz, 1150 W, for welding plastic drain pipes with electric sleeves in PE made by Akatherm-Euro, Coes, Geberit, Valsir, Waviduo, Ø 40 – 160 mm. Electronic control, with acoustic and visual monitoring of welding process. In sturdy, shock-proof plastic casing. Welding leads 4.40 m. In a carton.

	Art.-No.	
	261001	

Accessories

Description	Art.-No.	
Case	151615	



Powerful electric tools for efficient sleeve welding.
Can be used anywhere, free-hand or on the work bench.

Plastic pipes and fittings
in PB, PE, PP, PVDF Ø 16 – 125 mm

REMS MSG – heating element according to DVS. High quality PTFE coating of heating spigots/sockets.

Design

Handy, light, safe. Free-hand or work bench assembly. Supplied in standard with supporting stand and bench support for mounting the unit in a horizontal or vertical position (bench support not supplied for MSG 25).

Heating element according to DVS

Plate-shaped, plane parallel heating element according to DVS. Electric heater embedded in corrosion-resistant cast aluminium for indirect heat transfer. Heating spigots and heating sockets according to DVS. High-quality, long-lasting PTFE coating prevents adherence of plastic remnants as well as oxidizing, and enables easy cleaning. Ideal temperature distribution and constant temperature at the complete working area. Fastening screws in stainless steel.

Temperature and temperature control

Choice of

- adjustable temperature 180–290°C, preadjusted to 260°C for PP pipes, with electronic temperature control with tight tolerance (EE) or
- Fixed temperature for PP pipes at 263°C, with electronic temperature control with a tolerance of +/- 1% (FE).

The electronic and manual temperature control automatically controls the preadjusted temperature within the permitted range according to DVS. Temperature control lamp and power control lamp.



Supply format

REMS MSG. Sleeve welding unit for plastic pipes and fittings in PB, PE, PP, PVDF. Heating element 230 V, 50–60 Hz, without PTFE-coated heating spigots and heating sockets. Optionally adjustable temperature 180–290°C, pre-set for PP pipes at 260°C, with electronic temperature control (EE) or fixed temperature for PP pipes at 263°C, with electronic temperature control (FE). Support stand. Bench support for mounting the welding unit in a horizontal or vertical position (not for MSG 25). Hexagon key for assembly and dismantling of heating spigots and heating sockets. In a carton.

Description	Pipes Ø mm	Power W	Art.-No.
25 EE	16–25	500	256020
63 FE	16–63	800	256213
63 EE	16–63	800	256220
125 EE	16–125	1400	256320

Other voltages available.

Supply format

REMS MSG 63 FE Set. As REMS MSG 63 FE, but with PTFE-coated heating spigots, heating sockets for Ø 20, 25, 32 mm. Fastening screws in stainless steel. In steel case.

Description	Pipes Ø mm	Power W	Art.-No.
	16–63	800	256233

Other voltages available.

Supply format

REMS MSG 63 EE Set. As REMS MSG 63 EE, but with PTFE-coated heating spigots, heating sockets for Ø 20, 25, 32 mm. Fastening screws in stainless steel. In steel case.

Description	Pipes Ø mm	Power W	Art.-No.
	16–63	800	256240

Other voltages available.

Accessories

Description	Pipes Ø mm	Art.-No.
Heating spigot, heating socket, fastening screw in stainless steel	16	256400
	17	256410
	18	256420
	19	256430
	20	256440
	25	256450
	32	256460
	40	256470
	50	256480
	63	256490
	75	256500
	90	256510
	110	256520
125	256530	

Steel case

REMS MSG 25, REMS MSG 63	256242
REMS MSG 125	256342

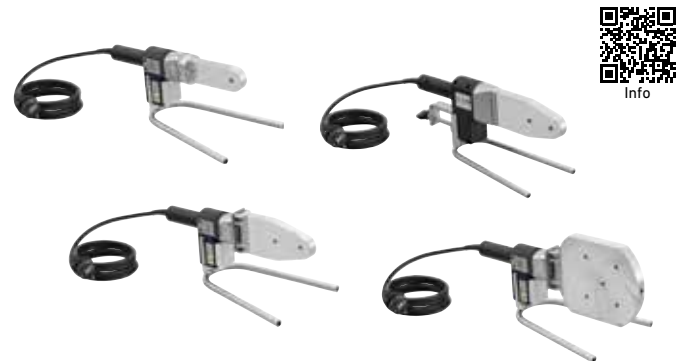

Handy, easy-to-carry compact machine. Complete only 45 kg. Ideal for sanitary installations and installation of drain pipes, chimney reconstruction with PVDF pipes. For job site and workshop.

Plastic pipes and fittings

in PB, PE, PP, PVDF

Ø 40–160 mm

PE Ø 40–90 mm	SDR ≥ 6
PE Ø 40–110 mm	SDR ≥ 9
PE Ø 40–125 mm	SDR ≥ 11
PE Ø 40–140 mm	SDR ≥ 17
PE Ø 40–160 mm	SDR ≥ 21

REMS SSM 160RS – ideal for the pipe fitter.

Light and compact. Heating element according to DVS.

Electronic temperature control. High-quality PTFE coating.

Powerful facing cutter. Closed facing cutter housing.

Design

Light and compact. Low weight, complete only 60 kg.

Can be easily carried by one person.

- Base frame in cast aluminium
- Free suspension of butt welding unit REMS SSG 180 for exact alignment of the faces to be welded
- Electric facing cutter unit for plane-parallel machining of pipe ends
- Smooth sliding, roller-bearing mounting of butt welding unit and electric facing cutter unit
- Quick clamping device, also suitable for angular branches.
- Pressing device, clear scale for easy reading of jointing pressure, clamping handle for pressure holding
- Can be used on the workbench or on the tubular stand provided as standard (= sub-frame = transport device).

Heating element according to DVS

Plate-shaped, plane parallel heating element according to DVS. Electric heater embedded in corrosion-resistant cast aluminium for indirect heat transfer. High-quality, long-lasting PTFE coating prevents adherence of plastic remnants as well as oxidizing, and enables easy cleaning. Ideal temperature distribution and constant temperature at the complete working area. Protective cover for heating element.

Electronic temperature control

Adjustable temperature 180–290°C, preset for PE pipes. The electronic temperature control automatically controls the preset temperature within the permitted range according to DVS. Temperature control lamp and power control lamp.

Facing cutter unit

Electric facing cutter unit with special, high torque universal motor, 500 W, for plane-parallel machining of one or both pipe ends according to DVS. Fast positioning of facing cutter with proven safety switch. Closed facing cutter housing. Specially hardened and specially ground planing blades guarantee easy, vibration-free planing.

Quick clamping device, also for angular branches

Sturdy quick clamping device made of nickel-plated steel, consisting of 2 vices with 2 clamping inserts each for pipes of Ø 40, 50, 56, 63, 75, 90, 110, 125, 135, 140, 160 mm. Also suitable for angular branches.

Pipe supports

Multiple adjustment, easy positioning of pipe supports for pipes Ø 160 mm for supporting and easy axial alignment of pipes and fittings. 2 pipe support inserts each for pipes Ø 40, 50, 56, 63, 75, 90, 110, 125, 135, 140 mm.

Supply format

REMS SSM 160RS. Butt welding machine for plastic pipes and fittings in PB, PE, PP, PVDF, PE Ø 40–90 mm SDR ≥ 6, PE Ø 40–110 mm SDR ≥ 9, PE Ø 40–125 mm SDR ≥ 11, PE Ø 40–140 mm SDR ≥ 17, PE Ø 40–160 mm SDR ≥ 21. Butt welding unit with PTFE-coated heating element 230 V, 50–60 Hz, 1200 W. Adjustable temperature 180–290°C, preset for PE pipes. Electronic temperature control. Protective cover for heating element. Electric planing device 230 V, 50–60 Hz, 500 W. Pressing device. Quick clamping device, also for angular branches, consisting of 2 vices with 2 clamping inserts each Ø 40, 50, 56, 63, 75, 90, 110, 125, 135, 140, 160 mm. 2 pipe rests Ø 160 mm with pipe rest inserts Ø 40, 50, 56, 63, 75, 90, 110, 125, 135, 140 mm. Work key. Steel case for pipe support inserts and clamp inserts. Tubular stand = base frame = carrying device.

	Art.-No.	
	252026	

Accessories

Description	Art.-No.	
Planing blade (piece)	252103	



REMS SSM 160KS

Butt welding machine

Powerful, proven, easy-to-transport compact machine. Ideal for sanitary installation, drain pipe installation, chimney reconstruction with PVDF pipes. For job site and workshop.

Plastic pipes and fittings		Ø 40 – 160 mm
in PB, PE, PP, PVDF		
PE Ø 40 – 90 mm	SDR ≥ 6	
PE Ø 40 – 110 mm	SDR ≥ 9	
PE Ø 40 – 125 mm	SDR ≥ 11	
PE Ø 40 – 140 mm	SDR ≥ 17	
PE Ø 40 – 160 mm	SDR ≥ 21	

REMS SSM 160KS – ideal for the pipe fitter. Heating element according to DVS. Electronic temperature control. High-quality PTFE coating. Powerful facing cutter. Closed facing cutter housing.

Design

- Compact, robust, job site-proven. Machine on sheet metal base weighs 101 kg. Easy to carry.
- Base frame in aluminium cast
 - Free suspension of butt welding unit REMS SSG 180 for exact alignment of the faces to be welded
 - Electric facing cutter unit for plane-parallel machining of pipe ends
 - Smooth sliding, roller-bearing mounting of butt welding unit and electric facing cutter unit
 - Quick clamping device, also suitable for angular branches.
 - Pressing device, clear scale for easy reading of jointing pressure, clamping handle for pressure holding
 - Machine on sheet steel base with built-in drawer for clamping and pipe rest inserts
 - Suitable for use on a work bench or on the standard supplied sheet metal cabinet (= carrying case).

Heating element according to DVS

Plate-shaped, plane-parallel heating element according to DVS. Electric heater embedded in corrosion-resistant cast aluminium for indirect heat transfer. High-quality, long-lasting PTFE coating prevents adherence of plastic remnants as well as oxidizing, and enables easy cleaning. Ideal temperature distribution and constant temperature at the complete working area. Protective cover for heating element.

Electronic temperature control

Adjustable temperature 180–290°C, preset for PE pipes. The electronic temperature control automatically controls the preset temperature within the permitted range according to DVS. Temperature control lamp and power control lamp.

Facing cutter unit

Electric facing cutter unit with special, high torque universal motor, 500 W, for plane-parallel machining of one or both pipe ends according to DVS. Fast positioning of facing cutter with proven safety switch. Closed facing cutter housing. Specially hardened and specially ground planing blades guarantee easy, vibration-free planing.

Quick clamping device, also for angular branches

Sturdy quick clamping device made of nickel-plated steel, consisting of 2 vices with 2 clamping inserts each for pipes of Ø 40, 50, 56, 63, 75, 90, 110, 125, 135, 140, 160 mm. Also suitable for angular branches.

Pipe supports

Multiple adjustment, easy positioning of pipe supports for pipes of Ø 160 mm for supporting and easy axial alignment of pipes and fittings. 2 pipe support inserts each for pipes Ø 40, 50, 56, 63, 75, 90, 110, 125, 135, 140 mm.

Supply format

REMS SSM 160KS. Butt welding machine for plastic pipes and fittings in PB, PE, PP, PVDF, PE Ø 40–90 mm SDR ≥ 6, PE Ø 40–110 mm SDR ≥ 9, PE Ø 40–125 mm SDR ≥ 11, PE Ø 40–140 mm SDR ≥ 17, PE Ø 40–160 mm SDR ≥ 21. Butt welding unit with PTFE-coated heating element 230 V 50–60 Hz, 1200 W. Adjustable temperature 180–290°C, preset for PE pipes. Electronic temperature control. Protective cover for heating element. Electric planing device 230 V, 50–60 Hz, 500 W. Pressing device. Quick clamping device, also for angular branches, consisting of 2 vices with 2 clamping inserts each Ø 40, 50, 56, 63, 75, 90, 110, 125, 135, 140, 160 mm. 2 pipe rests Ø 160 mm with pipe rest inserts Ø 40, 50, 56, 63, 75, 90, 110, 125, 135, 140 mm. Sheet steel base with built-in drawer. Work key. Closed sheet metal cabinet = carrying case.

	Art.-No.
	252046

Accessories

Description	Art.-No.
Planing blade (piece)	252103



Powerful, proven, easy-to-transport compact machine. Ideal for sanitary installation, drain pipe installation, chimney reconstruction with PVDF pipes. For job site and workshop.

Plastic pipes and fittings

in PB, PE, PP, PVDF

Ø 75–250 mm

PE Ø 75–140 mm	SDR ≥ 6
PE Ø 75–160 mm	SDR ≥ 9
PE Ø 75–180 mm	SDR ≥ 11
PE Ø 75–200 mm	SDR ≥ 13.6
PE Ø 75–225 mm	SDR ≥ 17.6
PE Ø 75–250 mm	SDR ≥ 22

REMS SSM 250KS – compact and robust.

Design

Compact, robust, job site-proven. Easy to carry.

Machine on sheet metal base weighs 109 kg.

- Base frame in aluminium cast
- Free suspension of butt welding unit for exact alignment of the faces to be welded
- Electric facing cutter unit for plane-parallel machining of pipe ends
- Smooth sliding, roller-bearing mounting of butt welding unit and electric facing cutter unit
- Quick clamping device, also suitable for angular branches.
- Pressing device, clear scale for easy reading of jointing pressure, clamping handle for pressure holding
- Machine on sheet steel base with built-in drawer for clamping and pipe rest inserts.
- Suitable for use on a work bench or on the standard supplied sheet metal cabinet (= carrying case).

Heating element according to DVS

Plate-shaped, plane-parallel heating element according to DVS. Electric heater embedded in corrosion-resistant cast aluminium for indirect heat transfer.

High-quality, long-lasting PTFE coating prevents adherence of plastic remnants as well as oxidizing, and enables easy cleaning. Ideal temperature distribution and constant temperature at the complete working area.

Electronic temperature control

Adjustable temperature 180–290°C, preset for PE pipes. The electronic temperature control automatically controls the preset temperature within the permitted range according to DVS. Temperature control lamp and power control lamp.

Facing cutter unit

Electric facing cutter unit with special, high torque universal motor, 500 W, for plane-parallel machining of one or both pipe ends according to DVS. Fast positioning of facing cutter with proven safety switch. Closed facing cutter housing. Specially hardened and specially ground planing blades guarantee easy, vibration-free planing.

Quick clamping device for angular branches

Sturdy quick clamping device made of nickel-plated steel which grips the pipe all round, consisting of 2 clamps Ø 250 mm with jaws Ø 250 mm, with 2 clamping jaws and 2 clamping inserts each for pipes of Ø 75, 90, 110, 125, 160, 200 mm. Also suitable for angular branches. Clamping jaws and clamping inserts available for pipes of Ø 140, 180, 225 mm.

Pipe supports

Multiple adjustment, easy positioning of pipe supports for supporting and easy axial alignment of pipes and fittings. 2 pipe support inserts each for pipes Ø 75, 90, 110, 125, 140, 160, 180, 200, 225, 250 mm. Pipe rest inserts available for pipes of Ø 140, 180, 225 mm.

Supply format

REMS SSM 250K. Butt welding machine for plastic pipes and fittings in PB, PE, PP, PVDF. PE Ø 75–140 mm SDR ≥ 6, PE Ø 75–160 mm SDR ≥ 9, PE Ø 75–180 mm SDR ≥ 11, PE Ø 75–200 mm SDR ≥ 13.6, PE Ø 75–225 mm SDR ≥ 17.6, PE Ø 75–250 mm SDR ≥ 22. Butt welding unit with PTFE-coated heating element 230 V, 50–60 Hz, 1300 W. Adjustable temperature 180–290°C, preset for PE pipes. Electronic temperature control. Electric facing cutter unit 230 V, 50–60 Hz, 500 W. Quick clamping device, also for angular branches, consisting of 2 clamps Ø 250 mm with jaws Ø 250 mm, with 2 clamping jaws and 2 clamping inserts each for pipes of Ø 75, 90, 110, 125, 160, 200 mm. 2 pipe rests with pipe rest inserts Ø 75, 90, 110, 125, 160, 200, 250 mm. Sheet steel base with built-in drawer. Work key. Closed sheet metal cabinet = carrying case.

	Art.-No.	
	254025	

Accessories

Description	Art.-No.	
Planing blade (piece)	254103	



Info



REMS SSM 315RF

Butt welding machine

Compact, easy-to-transport high-performance machine for sanitary installation, drain pipe installation, chimney reconstruction with PVDF pipes. For job site and workshop.

Plastic pipes and fittings

in PB, PE, PP, PVDF Ø 90 – 315 mm

PE Ø 90 – 180 mm	SDR ≥ 6
PE Ø 90 – 200 mm	SDR ≥ 7.4
PE Ø 90 – 225 mm	SDR ≥ 9
PE Ø 90 – 250 mm	SDR ≥ 13.6
PE Ø 90 – 280 mm	SDR ≥ 17
PE Ø 90 – 315 mm	SDR ≥ 21

REMS SSM 315RF – convenient for job site and workshop.

Design

Compact, robust, job site-proven. Weight including tubular stand on wheels 154 kg.

- Base frame in aluminium cast
- Free suspension of butt welding unit for exact alignment of the faces to be welded
- Electric facing cutter unit for plane-parallel machining of pipe ends
- Smooth sliding, roller-bearing mounting of butt welding unit and electric facing cutter unit
- Quick clamping device
- Pressing device, clear scale for easy reading of jointing pressure, clamping handle for pressure holding
- Standard supply with tubular wheel stand for secure standing and easy transport.

Heating element according to DVS

Plate-shaped, plane-parallel heating element according to DVS. Electric heater embedded in corrosion-resistant cast aluminium for indirect heat transfer. High-quality, long-lasting PTFE coating prevents adherence of plastic remnants as well as oxidizing, and enables easy cleaning. Ideal temperature distribution and constant temperature at the complete working area.

Electronic temperature control

Adjustable temperature 180 – 290 °C, preset for PE pipes. The electronic temperature control automatically controls the preset temperature within the permitted range according to DVS. Temperature control lamp and power control lamp.

Facing cutter unit

Electric facing cutter unit with special, high torque universal motor, 500 W, for plane-parallel machining of one or both pipe ends according to DVS. Fast positioning of facing cutter with proven safety switch. Closed facing cutter housing. Specially hardened and specially ground planing blades guarantee easy, vibration-free planing.

Quick clamping device

Sturdy quick clamping devices made of nickel-plated steel which grip the pipe all round, for pipes of Ø 315 mm. 4 clamping inserts each for pipes of Ø 90, 110, 125, 160, 200, 250 mm. Clamping inserts available for pipes of Ø 140, 180, 225, 280 mm.

Pipe supports

Multiple adjustment, easy positioning of pipe supports for pipes Ø 315 mm for supporting and easy axial alignment of pipes and fittings. 2 pipe rest inserts each for pipes of Ø 90, 110, 125, 160, 200, 250 mm. Pipe rest inserts available for pipes of Ø 140, 180, 225, 280 mm.

Supply format

REMS SSM 315RF. Butt welding machine for plastic pipes and fittings in PB, PE, PP, PVDF. PE Ø 90 – 180 mm SDR ≥ 6, PE Ø 90 – 200 mm SDR ≥ 7.4, PE Ø 90 – 225 mm SDR ≥ 9, PE Ø 90 – 250 mm SDR ≥ 13.6, PE Ø 90 – 280 mm SDR ≥ 17, PE Ø 90 – 315 mm SDR ≥ 21. Butt welding unit with PTFE-coated heating element 230 V, 50 – 60 Hz, 3000 W. Adjustable temperature 180 – 290 °C, preset for PE pipes. Electronic temperature control. Electric facing cutter unit 230 V, 50 – 60 Hz, 500 W. Pressing device. 2 quick clamping devices Ø 315 mm with 2 clamping inserts each for pipes of Ø 90, 110, 125, 160, 200, 250 mm. 2 pipe supports Ø 315 mm with pipe support inserts Ø 90, 110, 125, 160, 200, 250 mm. Ring spanner. Boxes for clamping and pipe rest inserts. Tubular stand on wheels.

Art.-No.
255020



Accessories

Description	Art.-No.
Planing blade (piece)	255103



Powerful electric tools for efficient butt welding.
Can be used anywhere, free-hand or on the work bench.

Plastic pipes and fittings
in PB, PE, PP, PVDF ≤ Ø 280 mm

REMS SSG – heating element according to DVS.

Electronic temperature control.

High-quality PTFE coating.

Design

Handy, light, safe. Free-hand or work bench assembly. Supplied as standard with supporting stand. Bench support available as accessory for mounting the unit in a horizontal or vertical position.

Heating element according to DVS

Plate-shaped, plane parallel heating element according to DVS. Electric heater embedded in corrosion-resistant cast aluminium for indirect heat transfer. High-quality, long-lasting PTFE coating prevents adherence of plastic remnants as well as oxidizing, and enables easy cleaning. Ideal temperature distribution and constant temperature at the complete working area.

Electronic temperature control

Adjustable temperature 180–290°C, preset for PE pipes. The electronic temperature control automatically controls the preset temperature within the permitted range according to DVS. Temperature control lamp and power control lamp.



Info



Supply format

REMS MSG. Butt welding unit for plastic pipes and fittings in PB, PE, PP, PVDF. PTFE-coated heating element 230 V, 50–60 Hz. Adjustable temperature 180–290°C, preset for PE pipes. Electronic temperature control. Support stand. In a carton.

Description	Heating element Ø mm	Pipes ≤ Ø mm	Power W	Art.-No.
110/45° EE	125	110	500	250020
125 EE	145	125	700	250120
180 EE	200	180	1200	250220
280 EE	300	280	1300	250320

Accessories

Description	Art.-No.
Bench support for mounting the unit in a horizontal or vertical position	
REMS SSG 110/45°, 125, 180	250041
REMS SSG 280	250341
Steel case	
REMS SSG 110/45°	250042
REMS SSG 125	250142
REMS SSG 180	250242
REMS SSG 280	250342
Protection cover for heating element	
REMS SSG 110, 110/45°, 125	250143
REMS SSG 180	250243
REMS SSG 280	250343

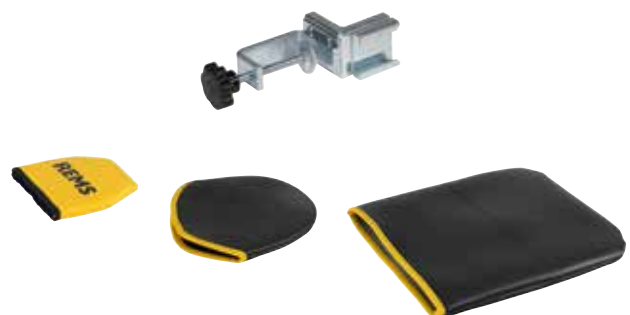













Diamond core drilling

Diamond chasing and cutting machine

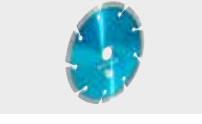
Wet and dry suction

	Electric diamond core drilling machines	300
	Drill stands	308
	Universal diamond core drilling crowns	310
	Universal diamond core drilling crowns LS	312
	Electric diamond core drilling machine with micro-pulse technology	314
	Dry diamond core drilling crowns LS	317
	Tile drilling	318
	Diamond chasing and cutting machines	320
	Diamond cutting discs	321
	Dry and wet extractor	322

Compact, handy power tool for core drilling, e.g. in concrete, steel-reinforced concrete, all kinds of masonry, natural stone, asphalt, all kinds of screed. Dry or wet drilling, hand held or with drill stand. For trade and industry.

Concrete, steel-reinforced concrete	≤ Ø 102 (132) mm
Masonry and other materials	≤ Ø 162 mm

REMS Universal diamond core drilling crowns, also suitable for drive machines of other makes, see page 310–312.

REMS Picus S1 – Core drilling instead of chiselling.
Easy, fast, vibration-free, e.g. 200 mm in steel-reinforced concrete Ø 62 mm in only 3 min.

1 system – 4 applications.
Ideal for plumbers.

Universal use

Universal drive machine for dry or wet drilling, hand held or with drill stand. Can be used anywhere, in narrow angles, flush with the wall. For many materials. For pipeline and cable ducting, ventilation channels, test core drilling.

System advantage

Only **one** type of universal diamond core drilling crowns for all REMS Picus drive machines and other suitable makes of drive machines. Therefore simple, low cost storage. No confusion possible.

Design

Compact, handy drive machine for vibration-free core drilling, with drilling crown connecting thread UNC 1¼ male, BSPP ½ female. Robust, suitable for the building site. Extra light, only 5.2 kg. Simple, fast work, e.g. 200 mm in steel-reinforced concrete Ø 62 mm in only 3 min. Practical spade handle and stabiliser for hand held drilling. Throat Ø 60 mm for holding the drive machine in the drill stand. Water supply for wet drilling, with adjustable shut-off valve and quick-coupling with water stop and hose connection ½". Suction rotor for sucking off dust for dry drilling with connection for conventional vacuum cleaner, as accessory.

Drive

Robust, powerful 1850 W universal motor. Load speed drilling spindle 580 rpm. Stable, maintenance-free gear. Blocking protection by safety slip clutch. Tip switch with lock. Connecting cable with integrated personal protection switch (PRCD).

Multifunction electronics

Multifunction electronics with start-up current limiting for soft starting for delicate drilling start, automatic idle speed limiting for noise reduction and preservation of the motor, overload and blocking protection for motor and gear.

Universal diamond core drilling crowns

Universally usable for dry and wet drilling, hand held or with drill stand. Optionally REMS Universal diamond core drilling crowns, inductively soldered, resolderable or REMS Universal diamond core drilling crowns LS, laser welded, high temperature-resistant (page 310–312). Connecting thread UNC 1¼ female. Drilling depth 420 mm. Specially developed, high quality diamond segments with high diamond percentage and special bonding, for excellent drilling performance and very long life. Ideal for universal applications in steel-reinforced concrete and masonry. Adapter for using the REMS Universal diamond core drilling crowns in drive machines of other makes, as accessory. Light loosening ring, for light loosening of the diamond core crown, as accessory.

Dust extraction in accordance with EN 60335-2-69

When working with mineral building materials, e.g. concrete, steel-reinforced concrete, masonry and screed, a high degree of mineral dust containing quartz is produced which is harmful to the health. Inhalation of quartz fine dust is harmful to the health. EN 60335-2-69 prescribes the use of at least one safety extractor of dust class M for the extraction of health hazardous dusts with an exposure limit/work place limit of > 0.1 mg/m³. Observe the national regulations.

Suction rotor for dust extraction in dry drilling with connection for REMS Pull 2 and other suitable extractors, as accessory (page 309). REMS Pull 2 M, wet and dry dust extractor, certified for extracting health hazardous dusts of dust class M (page 322).

Drilling start aid

Drilling start aid G ½ UDKB, with bores for extracting the drilling dust from the bore hole by a suction rotor for dust extraction, with carbide masonry drill Ø 8 mm.

Water extractor unit

Water extractor unit for wet drilling up to Ø 170 mm, consisting of a water collector ring with connection for REMS Pull 2 or other suitable wet extractors, compression ring, rubber washer Ø 200 mm, adaptable to diameter of the drill crown and universal pressure pad for all REMS drill stands, as accessory.

Drill stand

REMS Simplex 2 or REMS Titan drill stands can be used optionally (page 308).



Info



REMS Simplex 2



REMS Titan



REMS Picus S1 Basic-Pack

Supply format

REMS Picus S1 Basic-Pack. Electric diamond core drilling machine for core drilling in concrete, steel-reinforced concrete $\leq \varnothing 102$ (132) mm, masonry and other materials $\leq \varnothing 162$ mm. For dry and wet drilling, hand held or with drill stand. Drive machine with drilling crown connecting thread UNC 1 1/4 male, BSPP 1/2 female, maintenance-free gear with safety slip clutch, universal motor 230 V, 50–60 Hz, 1850 W. Multifunction electronics with soft starting, idle speed limiting, overload protection, blocking protection. Touch switch with lock. Personal protection switch (PRCD). Load speed drilling spindle 580 rpm. Water supply device with adjustable shut-off valve and quick coupling with water stop and 1/2" hose connection. Stabiliser. Drilling start aid G 1/2 UDKB with drill $\varnothing 8$ mm, Allen key size 3. Single open-ended wrench size 32. In sturdy steel case.

	Art.-No.	
	180010	

Other voltages on request.

Supply format

REMS Picus S1 Set Simplex 2. REMS Picus S1 Basic-Pack with REMS Simplex 2 drilling stand including tools and fastening kit for masonry and concrete.

	Art.-No.	
	180032	

Other voltages on request.



REMS Picus S1 Set Simplex 2

Accessories

Description	Art.-No.	
REMS Picus S1 drive unit	180000	
Steel case with inlay	180600	
REMS Universal diamond core drilling crowns , inductively soldered, resolderable, see page 310.		
REMS universal diamond core drilling crowns LS , laser welded, high temperature-resistant, see page 312.		
REMS Pull 2 L / M , dry and wet extractors, see page 322		
Additional accessories see page 308–309.		



Powerful, handy power tool for core drilling, e.g. in concrete, steel-reinforced concrete, all kinds of masonry, natural stone, asphalt, all kinds of screed. Dry or wet drilling, hand held or with drill stand. For trade and industry.

Concrete, steel-reinforced concrete	≤ Ø 152 (200) mm
Masonry and other materials	≤ Ø 250 mm

REMS Universal diamond core drilling crowns, also suitable for drive machines of other makes, see page 310–312.

REMS Picus S3 – Core drilling instead of chiselling.
Easy, fast, vibration-free, e.g. 200 mm in steel-reinforced concrete Ø 62 mm in only 3 min.

1 system – 4 applications.
Ideal for plumbers.

Universal use

Universal drive machine for dry or wet drilling, hand held or with drill stand. Can be used anywhere, in narrow angles, flush with the wall. Extremely versatile and efficient, e.g. drilling in steel-reinforced concrete, masonry and other materials. For pipeline and cable ducting, ventilation channels, test core drilling.

System advantage

Only **one** type of universal diamond core drilling crowns for all REMS Picus drive machines and other suitable makes of drive machines. Therefore simple, low cost storage. No confusion possible.

Design

Compact, handy drive machine for vibration-free core drilling, with drilling crown connecting thread UNC 1¼ male, BSPP ½ female. Robust, suitable for the building site. Only 7.4 kg. Simple, fast work, e.g. 200 mm in steel-reinforced concrete Ø 62 mm in only 3 min. Practical spade handle and stabiliser for hand held drilling. Throat Ø 60 mm for holding the drive machine in the drill stand. Water supply for wet drilling, with adjustable shut-off valve and quick-coupling with water stop and hose connection ½". Suction rotor for sucking off dust for dry drilling with connection for conventional vacuum cleaner, as accessory.

Drive

Robust, powerful 2200 W universal motor. Stable, maintenance-free 3-speed gear for optimum selection of load speed according to the drilling diameter. Load speed drilling spindle 530 rpm, 1280 rpm, 1780 rpm. Blocking protection by safety slip clutch. Tip switch with lock. Connecting cable with integrated personal protection switch (PRCD).

Multifunction electronics

Multifunction electronics with start-up current limiting for soft starting for delicate drilling start, automatic idle speed limiting for noise reduction and preservation of the motor, overload and blocking protection for motor and gear.

Universal diamond core drilling crowns

Universally usable for dry and wet drilling, hand held or with drill stand. Optionally REMS Universal diamond core drilling crowns, inductively soldered, resolderable or REMS Universal diamond core drilling crowns LS, laser welded, high temperature-resistant (page 310–312). Connecting thread UNC 1¼ female. Drilling depth 420 mm. Specially developed, high quality diamond segments with high diamond percentage and special bonding, for excellent drilling performance and very long life. Ideal for universal applications in steel-reinforced concrete and masonry. Adapter for using the REMS Universal diamond core drilling crowns in drive machines of other makes, as accessory. Light loosening ring, for light loosening of the diamond core crown, as accessory.

Dust extraction in accordance with EN 60335-2-69

When working with mineral building materials, e.g. concrete, steel-reinforced concrete, masonry and screed, a high degree of mineral dust containing quartz is produced which is harmful to the health. Inhalation of quartz fine dust is harmful to the health. EN 60335-2-69 prescribes the use of at least one safety extractor of dust class M for the extraction of health hazardous dusts with an exposure limit/work place limit of > 0.1 mg/m³. Observe the national regulations.

Suction rotor for dust extraction in dry drilling with connection for REMS Pull 2 and other suitable extractors, as accessory (page 309). REMS Pull 2 M, wet and dry dust extractor, certified for extracting health hazardous dusts of dust class M (page 322).

Drilling start aid

Drilling start aid G ½ UDKB, with bores for extracting the drilling dust from the bore hole by a suction rotor for dust extraction, with carbide masonry drill Ø 8 mm, as accessory.

Water extractor unit

Water extractor unit for wet drilling up to Ø 170 mm, consisting of a water collector ring with connection for REMS Pull 2 or other suitable wet extractors, compression ring, rubber washer Ø 200 mm, adaptable to diameter of the drill crown and universal pressure pad for all REMS drill stands, as accessory.

Drill stand

REMS Simplex 2 or REMS Titan drill stands can be used optionally (page 308).

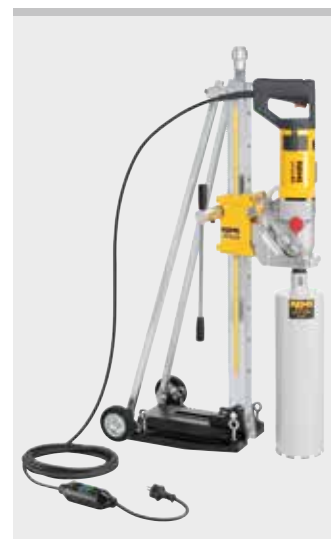

Info



REMS Simplex 2



REMS Titan



REMS Picus S3 Basic-Pack



REMS Picus S3 Set Titan



REMS Picus S3 Set 62-82-132 Titan

Supply format

REMS Picus S3 Basic-Pack. Electric diamond core drilling machine for core drilling in concrete, steel-reinforced concrete $\leq \varnothing 152$ (200) mm, masonry and other materials $\leq \varnothing 250$ mm. For dry and wet drilling, hand held or with drill stand. Drive machine with drilling crown connecting thread UNC 1 1/4 male, BSPP 1/2 female, maintenance-free 3-speed gear with safety slip clutch, universal motor 230 V, 50–60 Hz, 2200 W. Multifunction electronics with soft starting, idle speed limiting, overload protection, blocking protection. Touch switch with lock, personal protection switch (PRCD). Load speed drilling spindle 530 rpm, 1280 rpm, 1780 rpm. Water supply with adjustable shut-off valve and quick-coupling with water stop and hose connection 1/2". Stabiliser. Starting aid BSPP 1/2, Allen key size 3. Single open-ended wrench size 32. In sturdy steel case.

	Art.-No.	
	180011	

Other voltages on request.

Supply format

REMS Picus S3 Set Titan. REMS Picus S3 Basic-Pack with REMS Titan drilling stand including fastening kit for masonry and concrete.

	Art.-No.	
	180029	

Other voltages on request.

Supply format

REMS Picus S3 Set 62+82+132 Titan. REMS Picus S3 Basic-Pack with REMS Universal diamond core drilling crowns UDKB $\varnothing 62+82+132$ mm and REMS Titan drilling stand including fastening kit for masonry and concrete.

	Art.-No.	
	180028	

Other voltages on request.

Accessories

Description	Art.-No.	
REMS Picus S3 drive unit	180001	
Steel case with inlay	180600	
REMS Universal diamond core drilling crowns , inductively soldered, resolderable, see page 310.		
REMS universal diamond core drilling crowns LS , laser welded, high temperature-resistant, see page 312.		
REMS Pull 2 L / M , dry and wet extractors, see page 322		
Additional accessories see page 308–309.		



Compact, handy power tool for core drilling, e.g. in concrete, steel-reinforced concrete, all kinds of masonry, natural stone, asphalt, all kinds of screed. With speed regulation. Dry or wet drilling, hand held or with drill stand. For trade and industry.

Concrete, steel-reinforced concrete	≤ Ø 162 (200) mm
Masonry and other materials	≤ Ø 250 mm

REMS Universal diamond core drilling crowns, also suitable for drive machines of other makes, see page 310–312.

REMS Picus SR – Core drilling instead of chiselling. Easy, fast, vibration-free, e.g. 200 mm in steel-reinforced concrete Ø 62 mm in only 3 min. With speed regulation.

1 system – 4 applications.

Ideal for plumbers.

Universal use

Universal drive machine for dry or wet drilling, hand held or with drill stand. Can be used anywhere, in narrow angles, flush with the wall. Extremely versatile and efficient, e.g. drilling in steel-reinforced concrete, masonry and other materials. For pipeline and cable ducting, ventilation channels, test core drilling.

System advantage

Only **one** type of universal diamond core drilling crowns for all REMS Picus drive machines and other suitable makes of drive machines. Therefore simple, low cost storage. No confusion possible.

Design

Compact, handy drive machine for vibration-free core drilling, with drilling crown connecting thread UNC 1¼ male, BSPP ½ female. Robust, suitable for the building site. Extra light, only 6.4 kg. Simple, fast work, e.g. 200 mm in steel-reinforced concrete Ø 62 mm in only 3 min. Practical spade handle and stabiliser for hand held drilling. Throat Ø 60 mm for holding the drive machine in the drill stand. Spacer set for additional stabilisation of the REMS Picus SR drive unit on the REMS Titan drill stand. Water supply for wet drilling, with adjustable shut-off valve and quick-coupling with water stop and hose connection ½".

Drive

Robust, powerful 2200 W universal motor. Overheating protection by temperature monitoring of the motor's field winding with a PTC resistor (Positive Temperature Coefficient). Stable, maintenance-free, 2-step gear. Blocking protection by safety slip clutch. Tip switch with lock. Connecting cable with integrated personal protection switch (PRCD).

Speed-Regulation

Stepless electronic speed regulation of the drive machine for selecting the speed according to the material. The speed is steplessly adjustable on the dial: 250 rpm to 500 rpm (1st gear) or 600 rpm to 1200 rpm (2nd gear). The electronic speed control that is being used keeps the selected speed constant, also under load. The speed of the drilling crown is kept at the nominal value until it meets with resistance and drops below a critical value. The drive motor stops. When the load on the drive unit is relieved again, the drill runs back up to nominal speed so that work can continue immediately at nominal speed (Patent EP 2 085 191). Advantage: The optimum drilling speed (load speed) selected for the respective material and the drilling crown diameter remains constant for the entire duration of the drilling. For the best drilling performance and maximum life of the drilling crowns.

Multifunction electronics

Multifunction electronics with start-up current limiting for soft starting for delicate drilling start, automatic idle speed limiting for noise reduction and preservation of the motor, overload and blocking protection for motor and gear.

Universal diamond core drilling crowns

Universally usable for dry and wet drilling, hand held or with drill stand. Optionally REMS Universal diamond core drilling crowns, inductively soldered, resolderable or REMS Universal diamond core drilling crowns LS, laser welded, high temperature-resistant (page 310–312). Connecting thread UNC 1¼ female. Drilling depth 420 mm. Specially developed, high quality diamond segments with high diamond percentage and special bonding, for excellent drilling performance and very long life. Ideal for universal applications in steel-reinforced concrete and masonry. Adapter for using the REMS Universal diamond core drilling crowns in drive machines of other makes, as accessory. Light loosening ring, for light loosening of the diamond core crown, as accessory.

Dust extraction in accordance with EN 60335-2-69

When working with mineral building materials, e.g. concrete, steel-reinforced concrete, masonry and screed, a high degree of mineral dust containing quartz is produced which is harmful to the health. Inhalation of quartz fine dust is harmful to the health. EN 60335-2-69 prescribes the use of at least one safety extractor of dust class M for the extraction of health hazardous dusts with an exposure limit/work place limit of > 0.1 mg/m³. Observe the national regulations.

Suction rotor for dust extraction in dry drilling with connection for REMS Pull 2 and other suitable extractors, as accessory (page 309). REMS Pull 2 M, wet and dry dust extractor, certified for extracting health hazardous dusts of dust class M (page 322).

Patent EP 2 085 191

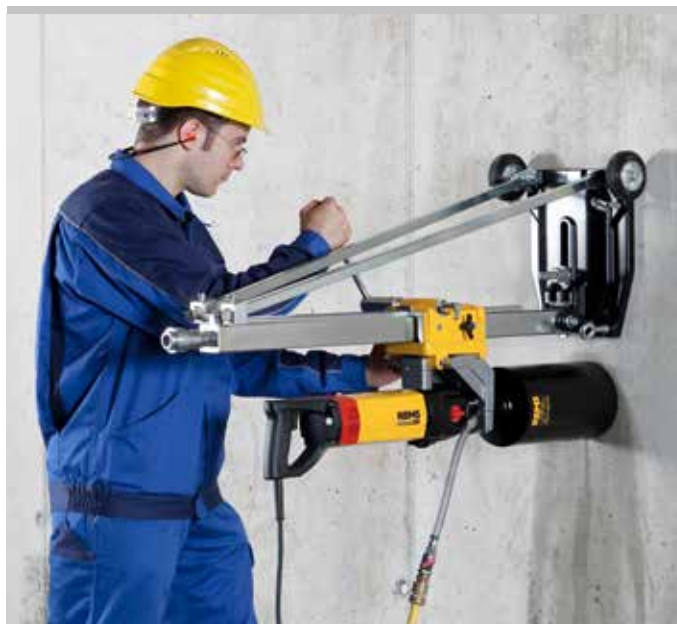

German Quality Product



Info

With speed regulation for the best drilling performance and maximum life of the drilling crowns.



REMS Simplex 2



REMS Titan

Drilling start aid

Drilling start aid G ½ UDKB, with bores for extracting the drilling dust from the bore hole by a suction rotor for dust extraction, with carbide masonry drill Ø 8 mm, as accessory.

Drill stand

REMS Simplex 2 or REMS Titan drill stands can be used optionally (page 308).

Water extractor unit

Water extractor unit for wet drilling up to Ø 170 mm, consisting of a water collector ring with connection for REMS Pull 2 or other suitable wet extractors, compression ring, rubber washer Ø 200 mm, adaptable to diameter of the drill crown and universal pressure pad for all REMS drill stands, as accessory.



REMS Picus SR Basic-Pack



REMS Picus SR Set Titan



REMS Picus SR Set 62-82-132 Titan

Supply format

REMS Picus SR Basic-Pack. For core drilling in concrete, steel-reinforced concrete ≤ Ø 162 (200) mm, masonry and other materials ≤ Ø 250 mm. For dry or wet drilling, hand held or with drill stand. Drive machine with drilling crown connection thread UNC 1¼ male, G ½ female, maintenance-free 2-step gear with safety slip clutch, universal motor 230 V, 50–60 Hz, 2200 W. Stepless electronic speed regulation 250 rpm to 500 rpm (1st gear) or 600 rpm to 1200 rpm (2nd gear), overheating protection. Multifunction electronics with soft starting, idle speed limiting, overload protection, blocking protection. Touch switch with lock. Personal protection switch (PRCD). Water supply device with adjustable shut-off valve and quick coupling with water stop and ½" hose connection. Stabiliser. Spacer set. Single open ended wrench size 32. In sturdy steel case.

Art.-No.	
183010	

Other voltages on request.

Supply format

REMS Picus SR Set Titan. REMS Picus SR Basic-Pack with REMS Titan drilling stand including fastening kit for masonry and concrete.

Art.-No.	
183022	

Other voltages on request.

Supply format

REMS Picus SR Set 62+82+132 Titan. REMS Picus SR Basic-Pack with REMS Titan drilling stand including fastening kit for masonry and concrete and REMS Universal diamond core drilling crowns UDKB Ø 62+82+132 mm.

Art.-No.	
183023	

Other voltages on request.

Accessories

Description	Art.-No.
REMS Picus SR drive unit	183000
Spacer set for additional stabilisation of the REMS Picus SR drive unit on the REMS Titan drill stand, consisting of spacer and 2 cylinder head screws M 8×65	183632
Steel case with inlay	180600
REMS Universal diamond core drilling crowns , inductively soldered, resolderable, see page 310.	
REMS universal diamond core drilling crowns LS , laser welded, high temperature-resistant, see page 312.	
REMS Pull 2 L / M , dry and wet extractors, see page 322	
Additional accessories see page 308–309.	



Powerful, robust core drilling machine for core drilling, e.g. in concrete, steel-reinforced concrete, all kinds of masonry, natural stone, asphalt, all kinds of screed. Dry or wet drilling with drill stand. For installation, metalwork, industry.

Concrete, steel-reinforced concrete, masonry and other materials \varnothing 40–300 mm

REMS Universal diamond core drilling crowns, also suitable for drive machines of other makes, see page 310–312.

REMS Picus S2/3,5 – Core drilling instead of chiselling. Easy, fast, vibration-free, e.g. 200 mm in steel-reinforced concrete \varnothing 62 mm in only 2 min.

Universal use

Universal drive machine for dry or wet drilling, hand held or with drill stand. Can be used anywhere, in narrow angles, flush with the wall. Extremely versatile and efficient, e.g. drilling in steel-reinforced concrete, masonry and other materials. For pipeline and cable ducting, ventilation channels, test core drilling.

System advantage

Only one type of universal diamond core drilling crowns for all REMS Picus drive machines and other suitable makes of drive machines. Therefore simple, low cost storage. No confusion possible.

Design

Compact, handy drive machine for vibration-free core drilling, with drilling crown connecting thread UNC 1 1/4 male. Light loosening ring, for light loosening of the diamond core crowns. Compact, robust, suitable for the building site. Weight just 14.4 kg. Simple, fast work, e.g. 200 mm in steel-reinforced concrete \varnothing 62 mm in only 2 min. Clamping plate for fast clamping to the drill stand. Water supply for wet drilling, with adjustable shut-off valve and quick coupling with water stop and hose connection 1/2".

Drive

Robust, powerful 3420 W universal motor. Stable, maintenance-free 2-speed gear for optimum selection of load speed according to the drilling diameter. Load speed drilling spindle 320 rpm, 760 rpm. Blocking protection by safety slip clutch. Rocker switch. Connecting cable with integrated personal protection switch (PRCD).

Multifunction electronics

Multifunction electronics with start-up current limiting for soft starting for delicate drilling start, automatic idle speed limiting for noise reduction and preservation of the motor, overload and blocking protection for motor and gear.

Universal diamond core drilling crowns

Universally usable for dry and wet drilling, hand held or with drill stand. Optionally REMS Universal diamond core drilling crowns, inductively soldered, resolderable or REMS Universal diamond core drilling crowns LS, laser welded, high temperature-resistant (page 310–312). Connecting thread UNC 1 1/4 female. Drilling depth 420 mm. Specially developed, high quality diamond segments with high diamond percentage and special bonding, for excellent drilling performance and very long life. Ideal for universal applications in steel-reinforced concrete and masonry. Adapter for using the REMS Universal diamond core drilling crowns in drive machines of other makes, as accessory. Light loosening ring, for light loosening of the diamond core crown, as accessory.

Water extractor unit

Water extractor unit for wet drilling up to \varnothing 170 mm, consisting of a water collector ring with connection for REMS Pull 2 or other suitable wet extractors, compression ring, rubber washer \varnothing 200 mm, adaptable to diameter of the drill crown and universal pressure pad for all REMS drill stands, as accessory.

Drill stand REMS Titan

Robust, highly stable drilling stand for core drilling in steel-reinforced concrete and other materials up to \varnothing 300 mm. For high demands. Drill column made of rigid, unbendable square precision steel tube \varnothing 50 mm, with extra narrow tolerance, for low-vibration guiding of the slide. Continuously tiltable with degree scale up to 45°, with double support by adjustable, single-part steel girders, for maximum thrust pressure. Highly stable, 3-sided guidance of the drill column in the base plate and triple cross fastening for high rigidity in vertical drilling. 4 Eyebolts for levelling unevenness of the floor, for exact standing position. Drill depth scale. Slide guided on all sides by adjustable, pretensioned plastic slide bearings. Precision in-feed drive ensures easy, low-vibration drilling and precise, low-vibration drill thrust. For high thrust pressure and long life of the drilling crowns. Spirit level integrated in the slide for exact alignment of the drill stand. Locking of the slide for simple assembly of the drilling crown and safe transport. Rigid connection plate made of wear-resistant spheroidal iron. Quick-clamping device for accommodating drive units with a suitable connection plate. Highly stable clamping bracket, unbendable and rigid, for accommodating drive units with \varnothing 60 mm clamping throat. Rack and pinion force transmission with ergonomically designed pressing lever which can be inserted in both sides of the slide. Wide steel rack. Base plate with groove for sealing ring of the vacuum fastening. Vacuum fastening as accessory. Drill column with adjustable clamping head for clamping the drill stand between the ceiling and floor or between two walls. Mobile drill stand for easy transport. Weight 19.5 kg.

With tools, consisting of Allen key size 6, single open ended wrench size SW 19 and SW 30 and fastening kit for masonry and concrete, consisting of 2 M12 splaying anchors, 10 M12 hammer anchors for concrete, setting iron for M12 hammer anchors, cord threaded bar M12 x 52, quick clamping nut, washer, carbide masonry drill \varnothing 15 mm SDS-plus, in box.



Info



REMS Titan



REMS Picus S2/3,5 Basic-Pack

Supply format

REMS Picus S2/3,5 Basic-Pack. Electric diamond core drilling machine for core drilling in concrete, steel-reinforced concrete, all kinds of masonry, natural stone, asphalt, all kinds of screed, Ø 40 – 300 mm. For dry and wet drilling with drill stand. Drive machine with drilling crown connecting thread UNC 1 1/4 male, maintenance-free 2-speed gear with safety slip clutch, universal motor 230 V, 50 – 60 Hz, 3420 W. Multifunction electronics with soft starting, idle speed limiting, overload protection, blocking protection. Touch switch with lock. Personal protection switch (PRCD). Load speed drilling spindle 320 rpm, 760 rpm. Water supply device with adjustable shut-off valve and quick coupling with water stop and hose connection 1/2". Light loosening ring. Single open-ended wrench size 32. In a carton.

	Art.-No.	
	180012	

Other voltages on request.

Supply format

REMS Picus S2/3,5 Set Titan. REMS Picus SR/3.5 Basic-Pack with REMS Titan drilling stand including fastening kit for masonry and concrete.

	Art.-No.	
	180030	

Other voltages on request.



REMS Picus S2/3,5 Set Titan

Accessories

Description

REMS Universal diamond core drilling crowns, inductively soldered, resolderable, see page 310.

REMS universal diamond core drilling crowns LS, laser welded, high temperature-resistant, see page 312.

REMS Pull 2 L / M, dry and wet extractors, see page 322

Additional accessories see page 308 – 309.



Supply format

REMS Simplex 2. Robust, handy drilling stand for core drilling up to Ø 202 mm. Drill column made of rigid, unbendable square precision steel tube \varnothing 50 mm, with extra narrow tolerance, for low-vibration guiding of the slide. Drilling column guided in sturdy stand and double bolted for high rigidity during drilling. Steel section stand. 4 Set screws for levelling unevenness of the floor, for exact standing position. Clamping bracket for holding drive machines with clamping throat \varnothing 60 mm. Slide guided on all sides by adjustable, pretensioned plastic slide bearings. Precision in-feed drive ensures easy, low-vibration drilling and precise, low-vibration drill thrust. For high thrust pressure and long life of the drilling crowns. Spirit level integrated in the slide for exact alignment of the drill stand. Locking of the slide for simple assembly of the drilling crown and safe transport. Stable clamping bracket, unbendable and rigid, for accommodating drive units with \varnothing 60 mm clamping throat. Rack and pinion force transmission with ergonomically designed pressing lever which can be inserted in both sides of the slide. Wide steel rack Weight 12 kg.

With tools comprising Allen key size 6, single open ended wrench size SW 19 and SW 30 and fastening kit for masonry and concrete, consisting of 2 M12 splaying anchors, 10 M12 hammer anchors for concrete, setting iron for M12 hammer anchors, cord threaded bar M12 \times 52, quick clamping nut, washer, carbide masonry drill \varnothing 15 mm SDS-plus in box.

For REMS Picus S1, REMS Picus S3, REMS Picus SR, REMS Picus DP and other makes.

	Art.-No.	
	183700	



Supply format

REMS Titan. Robust, highly stable drilling stand for core drilling in steel-reinforced concrete and other materials up to Ø 300 mm. For high demands. Drill column made of rigid, unbendable square precision steel tube \varnothing 50 mm, with extra narrow tolerance, for low-vibration guiding of the slide. Continuously tiltable with degree scale up to 45°, with double support by adjustable, single-part steel girders, for maximum thrust pressure. Highly stable, 3-sided guidance of the drill column in the base plate and triple cross fastening for high rigidity in vertical drilling. 4 Eyebolts for levelling unevenness of the floor, for exact standing position. Drill depth scale. Slide guided on all sides by adjustable, pretensioned plastic slide bearings. Precision in-feed drive ensures easy, low-vibration drilling and precise, low-vibration drill thrust. For high thrust pressure and long life of the drilling crowns. Spirit level integrated in the slide for exact alignment of the drill stand. Locking of the slide for simple assembly of the drilling crown and safe transport. Rigid connection plate made of wear-resistant spheroidal iron. Quick-clamping device for accommodating drive units with a suitable connection plate. Highly stable clamping bracket, unbendable and rigid, for accommodating drive units with \varnothing 60 mm clamping throat. Rack and pinion force transmission with ergonomically designed pressing lever which can be inserted in both sides of the slide. Wide steel rack. Base plate with groove for sealing ring of the vacuum fastening. Vacuum fastening as accessory. Drill column with adjustable clamping head for clamping the drill stand between the ceiling and floor or between two walls. Mobile drill stand for easy transport Weight 19,5 kg.

With tools comprising Allen key size 6, single open ended wrench size SW 19 and SW 30 and fastening kit for masonry and concrete, consisting of 2 M12 splaying anchors, 10 M12 hammer anchors for concrete, setting iron for M12 hammer anchors, cord threaded bar M12 \times 52, quick clamping nut, washer, carbide masonry drill \varnothing 15 mm SDS-plus in box.

System advantage: For REMS Picus S1, REMS Picus S3, REMS Picus SR, REMS Picus S2/3,5, REMS Picus DP and other makes. Use spacer set (see below) when using with REMS Picus SR.

	Art.-No.	
	183600	



Description	Art.-No.	
Spacer set for additional stabilisation of the REMS Picus SR drive unit on the REMS Titan drill stand, consisting of spacer and 2 cylinder head screws M 8 \times 65	183632	



Accessories

For REMS Picus S1, REMS Picus S3, REMS Picus SR, REMS Picus S2/3,5 and other makes

Description	Art.-No.
Water pressure tank for 10 ltr of water, for wet drilling without water connection	182006
Titan drilling template for easy setting of the fastening holes. For REMS Titan drilling stand.	183605
Carbide masonry drills Ø 15 mm SDS-plus for hammer anchors M12	079018
Hammer anchor M12 (pack of 50) , for concrete	079005
Setting iron for hammer anchor M12	182050
Carbide masonry drill Ø 20 mm SDS-plus for splaying anchors M12	079019
Splaying anchor M12 (pack of 10) , for masonry, reusable	079006
Quick clamping set 160 for fastening the drilling stand with anchors, consisting of cord threaded bar 160 mm with M12 x 52 thread, quick clamping nut, washer.	079010
Quick clamping set 500 for fastening the drilling stand without anchor, consisting of cord threaded bar 500 mm, 2 quick clamping nuts, 2 washers	183607
Titan vacuum fastening , consisting of cover plate with nipple for 3/8" screw connection and sealing ring for base plate.	183603
Vacuum pump , for vacuum ≤ -900 mbar (90%), consisting of dry running rotary slide pump, oil-free, performance 6 m ³ /h, condenser motor 230 V, 50–60 Hz, 250 W, splash water-protected, inside suction filter with silencer function and 5 m PVC fabric hose with bayonet coupling.	183670
Laser drilling centre pointer	183604
Drilling start aid G 1/2 UDKB , with bores for extracting the drilling dust from the bore hole by a suction rotor for dust extraction (Art. No. 180160 R), with carbide masonry drill Ø 8 mm	180140
Carbide masonry drill Ø 8 mm for drilling aid	079013
Single open ended wrench size 41 for loosening the universal diamond core drilling crowns	079003
Light loosening ring , for light loosening of the diamond core crown	180015
Drilling crown extension 200 mm	180155
Sharpening stone for diamond core drilling crowns	079012
Circular spirit level , magnetic, for aligning the drill stand	182010
Suction rotor for dust extraction with G 1/2 male connecting thread, UNC 1 1/4 male connecting thread and with connection for REMS Pull 2 and other suitable extractors.	180160
Water suction device , for wet drilling up to Ø 170 mm, consisting of water collection ring with pressure ring, rubber washer Ø 200 mm and universal pressure pad for all REMS drilling stands.	183606
Rubber washer Ø 200 mm (pack of 10) , for water suction device	183675
REMS Pull 2 L / M , dry and wet extractor, certified as extractor and dust extractor for extracting health hazardous dusts in accordance with EN 60335-2-69, see page 322	

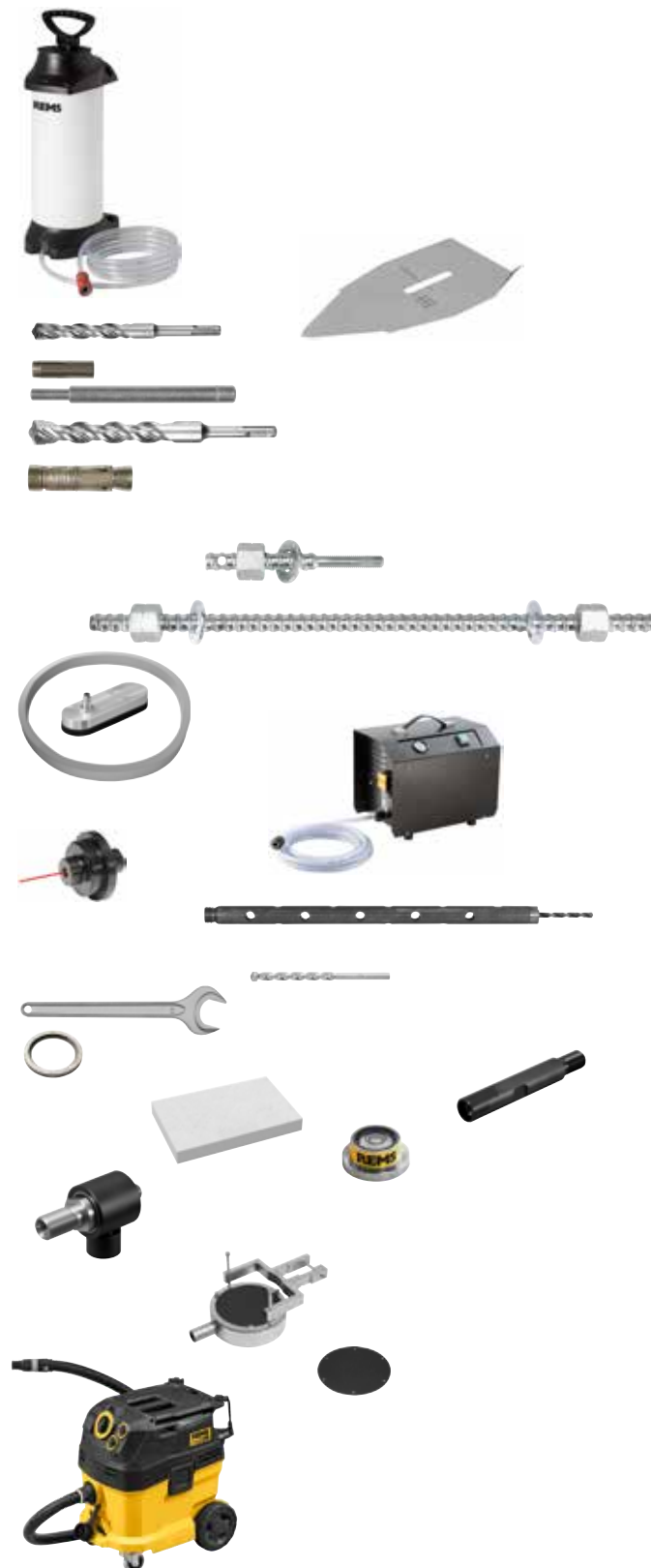

REMS Universal diamond core drilling crowns

For REMS Picus S1, REMS Picus SR, REMS Picus S3, REMS Picus S2/3,5 and other makes

High quality universal diamond core drilling crowns. Inductively soldered. Universally usable for dry and wet drilling, hand held or with drill stand. Ideal for universal applications in steel-reinforced concrete, masonry and many types of material. For installation, metalwork, industry.

Concrete, steel-reinforced concrete, all kinds of masonry, natural stone, asphalt, all kinds of screed and other Ø 32 – 300 mm

REMS Universal diamond core drilling crowns – Inductively soldered. Diamond segments with conical cut for fast, easy and quiet drilling. Versatile for many types of material. Ideal for plumbers.

Universally usable for many materials, for dry and wet drilling, hand held or with drill stand.

Single connecting thread UNC 1¼ female. Drilling depth 420 mm.

Specially developed, high quality diamond segments with high diamond percentage and special bonding, for excellent drilling performance and very long life. Ideal for universal applications in steel-reinforced concrete and masonry.

Diamond segments with conical cut ("roof shape") for fast, easy and quiet drilling. Inductively soldered on fully automatic soldering machines for constant high quality of the soldered connection. Drilling tubes with soldered diamond segments can be resoldered by simple hard soldering.

Light loosening ring, for light loosening of the diamond core crowns, as accessory.

Drive through all REMS Picus drive machines and suitable drive machines of other makes having connecting thread UNC 1¼ male. Adapter for using REMS Universal diamond core drilling crowns in drive machines having other connecting threads, as accessory.

Suck off dusts that occur during dry drilling with REMS Pull 2 M safety vacuum cleaner, certified for extracting health hazardous dusts of dust class M (page 322).

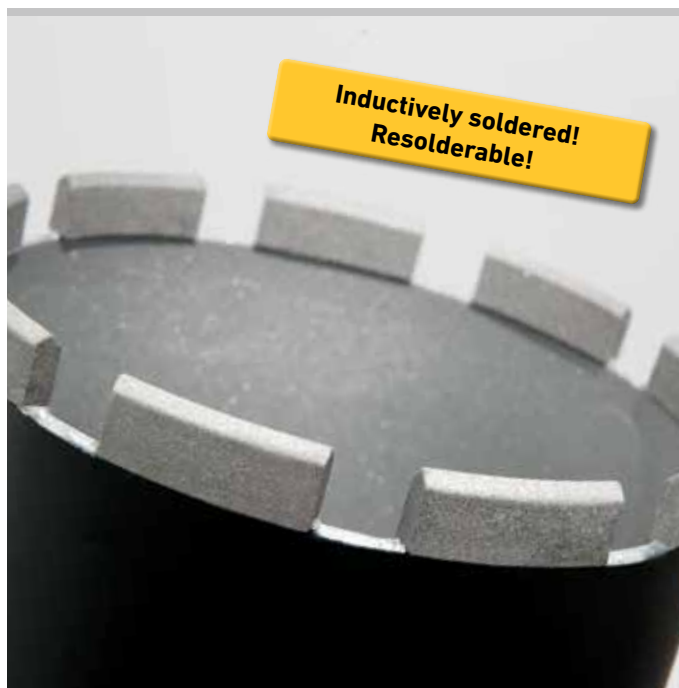

Info

REMS Universal diamond core drilling crowns

For REMS Picus S1, REMS Picus SR, REMS Picus S3, REMS Picus S2/3,5 and other makes

Supply format

REMS Universal diamond core drilling crown. Inductively soldered, resolderable. Universally usable for dry and wet drilling, hand held or with drill stand. For many materials, e.g. concrete, steel-reinforced concrete, all kinds of masonry, natural stone, asphalt, all kinds of screed. Connecting thread UNC 1 1/4 female. Drilling depth 420 mm. In a carton.

Ø × drilling depth × connection	Number of segments	Art.-No.
UDKB 32 × 420 × UNC 1 1/4	4	181010
UDKB 42 × 420 × UNC 1 1/4	4	181015
UDKB 52 × 420 × UNC 1 1/4	5	181020
UDKB 62 × 420 × UNC 1 1/4	6	181025
UDKB 72 × 420 × UNC 1 1/4	7	181030
UDKB 82 × 420 × UNC 1 1/4	7	181035
UDKB 92 × 420 × UNC 1 1/4	8	181040
UDKB 102 × 420 × UNC 1 1/4	8	181045
UDKB 112 × 420 × UNC 1 1/4	9	181050
UDKB 122 × 420 × UNC 1 1/4	10	181055
UDKB 127 × 420 × UNC 1 1/4	10	181059
UDKB 132 × 420 × UNC 1 1/4	11	181060
UDKB 152 × 420 × UNC 1 1/4	12	181065
UDKB 162 × 420 × UNC 1 1/4	12	181070
UDKB 182 × 420 × UNC 1 1/4	12	181075
UDKB 200 × 420 × UNC 1 1/4	12	181080
UDKB 225 × 420 × UNC 1 1/4	13	181085
UDKB 250 × 420 × UNC 1 1/4	14	181090
UDKB 300 × 420 × UNC 1 1/4	22	181095



Accessories

Description	Art.-No.
Light loosening ring, for light loosening of the diamond core crown	180015
Drilling crown extension 200 mm	180155
Adapter UNC 1 1/4 male to G 1/2 male	180052
Adapter UNC 1 1/4 male to G 1/2 female	180056
Adapter UNC 1 1/4 male for Hilti BI, adapter for using the REMS universal diamond core drilling crowns in Hilti BI drive units.	180053
Adapter UNC 1 1/4 male for Hilti BU, adapter for using the REMS universal diamond core drilling crowns in Hilti BU drive units.	180054
Sharpening stone for diamond core drilling crowns	079012
Single open ended wrench size 41 for UDKB	079003

Additional adapters for using REMS Universal diamond core drilling crowns LS in drive machines of other makes, on request.



REMS Universal diamond core drilling crowns LS

For REMS Picus S1, REMS Picus SR, REMS Picus S3, REMS Picus S2/3,5 and other makes

High quality universal diamond core drilling crowns. Laser welded. Universally usable for dry and wet drilling, hand held or with drill stand. Ideal for universal applications in steel-reinforced concrete, masonry and many types of material. For installation, metalwork, industry.

Concrete, steel-reinforced concrete, all kinds of masonry, natural stone, asphalt, all kinds of screed and other Ø 32–200 mm

REMS universal diamond core drilling crowns LS – laser welded. Diamond segments with conical cut for fast, easy and quiet drilling. Versatile for many types of material. Ideal for plumbers.

Universally usable for many materials, for dry and wet drilling, hand held or with drill stand.

Single connecting thread UNC 1¼ female. Drilling depth 420 mm.

Specially developed, high quality diamond segments with high diamond percentage and special bonding, for excellent drilling performance and very long life. Ideal for universal applications in steel-reinforced concrete and masonry.

Diamond segments with conical cut ("roof shape") for fast, easy and quiet drilling. Inductively soldered on fully automatic soldering machines for constant high quality of the soldered connection. Drilling tubes with soldered diamond segments can be resoldered by simple hard soldering.

Light loosening ring, for light loosening of the diamond core crowns, as accessory.

Drive through all REMS Picus drive machines and suitable drive machines of other makes having connecting thread UNC 1¼ male. Adapter for using REMS Universal diamond core drilling crowns LS in drive machines having other connecting threads, as accessory.

Suck off dusts that occur during dry drilling with REMS Pull 2 M safety vacuum cleaner, certified for extracting health hazardous dusts of dust class M (page 322).

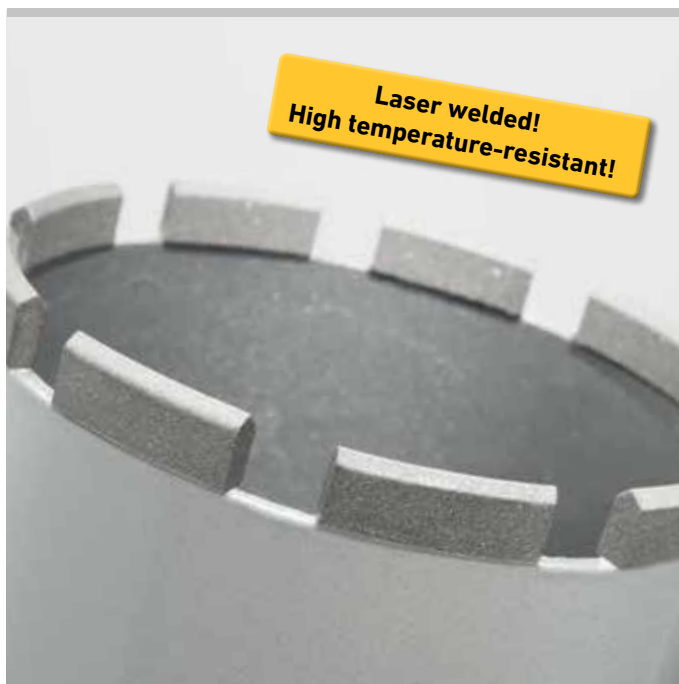

Info

REMS Universal diamond core drilling crowns LS

For REMS Picus S1, REMS Picus SR, REMS Picus S3, REMS Picus S2/3,5 and other makes

Supply format

REMS Universal diamond core drilling crown. Laser welded! High temperature-resistant! Universally usable for dry and wet drilling, hand held or with drill stand. For many materials, e.g. concrete, steel-reinforced concrete, all kinds of masonry, natural stone, asphalt, all kinds of screed. Connecting thread UNC 1 ¼ female. Drilling depth 420 mm. In a carton.

Ø × drilling depth × connection	Number of segments	Art.-No.
UDKB LS 32 × 420 × UNC 1 ¼	1	181410
UDKB LS 42 × 420 × UNC 1 ¼	4	181415
UDKB LS 52 × 420 × UNC 1 ¼	5	181420
UDKB LS 62 × 420 × UNC 1 ¼	6	181425
UDKB LS 72 × 420 × UNC 1 ¼	6	181430
UDKB LS 82 × 420 × UNC 1 ¼	7	181435
UDKB LS 92 × 420 × UNC 1 ¼	8	181440
UDKB LS 102 × 420 × UNC 1 ¼	9	181445
UDKB LS 112 × 420 × UNC 1 ¼	9	181450
UDKB LS 122 × 420 × UNC 1 ¼	10	181455
UDKB LS 127 × 420 × UNC 1 ¼	10	181459
UDKB LS 132 × 420 × UNC 1 ¼	10	181460
UDKB LS 152 × 420 × UNC 1 ¼	11	181465
UDKB LS 162 × 420 × UNC 1 ¼	12	181470
UDKB LS 182 × 420 × UNC 1 ¼	13	181475
UDKB LS 200 × 420 × UNC 1 ¼	14	181480

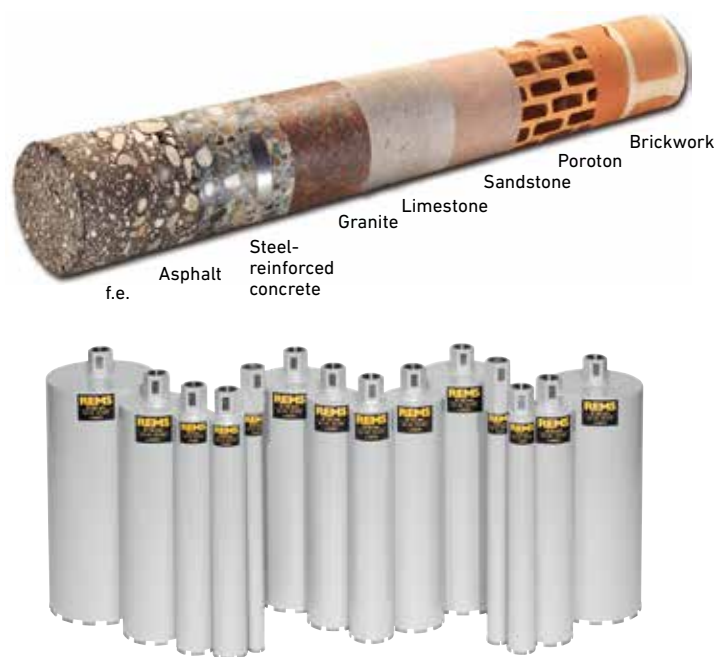

Accessories

Description	Art.-No.
Light loosening ring , for light loosening of the diamond core crown	180015
Drilling crown extension 200 mm	180155
Adapter UNC 1 ¼ male to G ½ male	180052
Adapter UNC 1 ¼ male to G ½ female	180056
Adapter UNC 1 ¼ male for Hilti BI , adapter for using the REMS universal diamond core drilling crowns in Hilti BI drive units.	180053
Adapter UNC 1 ¼ male for Hilti BU , adapter for using the REMS universal diamond core drilling crowns in Hilti BU drive units.	180054
Sharpening stone for diamond core drilling crowns	079012
Single open ended wrench size 41 for UDKB	079003

Additional adapters for using REMS Universal diamond core drilling crowns LS in drive machines of other makes, on request.



REMS Picus DP

Electric diamond core drilling machine
with micro-pulse technology

Compact, handy power tool for core drilling, e.g. in concrete, steel-reinforced concrete, all kinds of masonry, natural stone, asphalt, all kinds of screed. With micro-pulse technology. Especially for dry drilling, hand held or with drill stand. For trade and industry.

Concrete, steel-reinforced concrete ≤ Ø 162 (202) mm

Masonry and other materials ≤ Ø 202 mm

REMS dry diamond core drilling crowns, also suitable for drive machines of other makes, see page 317.

REMS Picus DP – with micro-pulse technology

For core drilling without water. Clean, easy, fast, e.g. 200 mm in steel-reinforced concrete Ø 62 mm in only 5 min.

Especially for dry drilling

Drive machine with micro-pulse technology, specially developed for dry drilling, hand held or with drill stand. Can be used anywhere, in narrow angles, flush with the wall. Suitable for many, especially hard materials. For pipeline and cable ducting, ventilation channels, test core drilling. In combination with the REMS Pull 2 M vacuum cleaner, ideal for making core bores in finished rooms, e.g. in residential, office and industrial buildings.

Design

Compact, handy drive machine for low-vibration core drilling, with drilling crown connecting thread UNC 1 ¼ male, BSPP ½ female. Compact drive unit for low-vibration core drilling, with drilling crown connecting thread UNC 1 ¼ outside, G ½ inside. Micro-pulse technology can be switched on and off: Pulse disc with 24 teeth generates 28,800 pulses min⁻¹ in idle mode at 1,200 min⁻¹, under load at 880 min⁻¹ 21,120 pulses min⁻¹. Robust, suitable for the building site. Extra light, only 7 kg. Simple, fast work without water, e.g. 200 mm in steel-reinforced concrete Ø 62 mm in only 5 min. Practical spade handle and stabiliser for hand held drilling. Integrated suction rotor for dust extraction with connection for REMS Pull 2 M and other suitable vacuum cleaners. Throat Ø 60 mm for holding the drive machine in the drill stand.

Drive

Robust, powerful 2200 W universal motor. Load speed drilling spindle 8080 rpm. Stable, maintenance-free gear. Blocking protection by safety slip clutch. Tip switch with lock. Connecting cable with integrated personal protection switch (PRCD).

Multifunction electronics

Multifunction electronics with start-up current limiting for soft starting for delicate drilling start, automatic idle speed limiting for noise reduction and preservation of the motor, overload and blocking protection for motor and gear.

Dry diamond core drilling crowns LS

Especially for dry drilling with core drilling machines with micro-pulse technology, laser welded, high temperature-resistant (page 317), for drilling without water, hand held or with drill stand. Connecting thread UNC 1 ¼ female. Drilling depth 320 mm. Specially developed, high quality diamond segments with high diamond percentage and special bonding, for excellent drilling performance and very long life. Ideal for dry drilling in steel-reinforced concrete and masonry. Light loosening ring, for light loosening of the dry diamond core drilling crown, as accessory.

Dust extraction in accordance with EN 60335-2-69

When working with mineral building materials, e.g. concrete, steel-reinforced concrete, masonry and screed, a high degree of mineral dust containing quartz is produced which is harmful to the health. Inhalation of quartz fine dust is harmful to the health. EN 60335-2-69 prescribes the use of at least one safety extractor of dust class M for the extraction of health hazardous dusts with an exposure limit/work place limit of > 0.1 mg/m³. Observe the national regulations.

Use REMS Pull 2 M for high-performance extraction of drilling dusts from the drilling gap during dry drilling (page 322). The REMS Pull 2 M safety vacuum cleaner is certified for extracting health hazardous dusts of dust class M.

Drilling start aid

Drilling start aid G ½ TDKB, with bores for extracting the drilling dust from the bore hole, with carbide masonry drill Ø 8 mm.

Drill stand

REMS Simplex 2 or REMS Titan drill stands can be used optionally (page 316).



German Quality Product



Info



REMS Simplex 2



REMS Titan



REMS Picus DP Basic-Pack



REMS Picus DP Set Simplex 2



REMS Picus DP Set Titan



REMS Picus DP/Pull 2 M Set-Pack

Supply format

REMS Picus DP Basic-Pack. Electric diamond core drilling machine with micro-pulse technology for core drilling without water in concrete, steel-reinforced concrete $\leq \varnothing 162$ (202) mm, masonry and other materials $\leq \varnothing 202$ mm, hand held or with drill stand. Drive unit with drilling crown male connection thread UNC 1 1/4, female connection thread G 1/2, maintenance-free gear with safety slip clutch, 110 V / 230 V, 50–60 Hz, 2200 W universal motor, integrated dust extraction. Multifunction electronics with soft starting, idle speed limiting, overload protection, blocking protection. Touch switch with lock. Load speed drilling spindle 880 rpm. Stabiliser. Drill start aid G 1/2 TDKB with $\varnothing 8$ mm drill, size 3 Allen key. Size 32 opened ended wrench. In sturdy steel case.

	Art.-No.	
	180016	

Other voltages on request.

Supply format

REMS Picus DP Set Simplex 2. REMS Picus DP Basic-Pack with REMS Simplex 2 drilling stand including tools and fastening kit for masonry and concrete.

	Art.-No.	
	180033	

Other voltages on request.

Supply format

REMS Picus DP Set Titan. REMS Picus DP Basic-Pack with REMS Titan drilling stand including tools and fastening kit for masonry and concrete.

	Art.-No.	
	180035	

Other voltages on request.

Supply format

REMS Picus DP/Pull 2 M Set-Pack. REMS Picus DP Basic-Pack, Art.-No. 180016 R110G, and REMS Pull 2 M Set, Art.-No. 185601 R220G.

	Art.-No.	
	180036	

Other voltages on request.

Accessories

Description	Art.-No.	
REMS Picus DP drive unit	180003	
Steel case with inlay	180600	
REMS dry diamond core drilling crowns LS, laser welded, high temperature-resistant, see page 317.		
REMS Pull 2 M, dry and wet extractor, see page 322		
Additional accessories see page 316.		



Description	Art.-No.
REMS Simplex 2. Robust, handy drilling stand for core drilling up to Ø 202 mm. Description see page 308.	183700
REMS Titan. Robust, highly stable drilling stand for core drilling in steel-reinforced concrete and other materials up to Ø 300 mm. For high demands. Description see page 308.	183600
Titan drilling template for easy setting of the fastening holes. For REMS Titan drilling stand.	183605
Carbide masonry drills Ø 15 mm SDS-plus for hammer anchors M12	079018
Hammer anchor M12 (pack of 50) , for concrete	079005
Setting iron for hammer anchor M12	182050
Carbide masonry drill Ø 20 mm SDS-plus for splaying anchors M12	079019
Splaying anchor M12 (pack of 10) , for masonry, reusable	079006
Quick clamping set 160 for fastening the drilling stand with anchors, consisting of cord threaded bar 160 mm with M12 × 52 thread, quick clamping nut, washer.	079010
Quick clamping set 500 for fastening the drilling stand without anchor, consisting of cord threaded bar 500 mm, 2 quick clamping nuts, 2 washers	183607
Titan vacuum fastening , consisting of cover plate with nipple for 3/8" screw connection and sealing ring for base plate.	183603
Vacuum pump , for vacuum ≤ -900 mbar (90%), consisting of dry running rotary slide pump, oil-free, performance 6 m ³ /h, condenser motor 230 V, 50–60 Hz, 250 W, splash water-protected, inside suction filter with silencer function and 5 m PVC fabric hose with bayonet coupling.	183670
Laser drilling centre pointer	183604
Drilling start aid G 1/2 TDKB , with bores for extracting the drilling dust from the bore hole, with carbide masonry drill Ø 8 mm	180145
Carbide masonry drill Ø 8 mm for drilling aid	079013
Single open ended wrench size 41 for loosening the universal diamond core drilling crowns	079003
Light loosening ring , for light loosening of the diamond core crown	180015
Drilling crown extension 200 mm	180155
Sharpening stone for diamond core drilling crowns	079012
Circular spirit level , magnetic, for aligning the drill stand	182010
REMS Pull 2 M , dry and wet extractor, certified as extractor and dust extractor for extracting health hazardous dusts in accordance with EN 60335-2-69, see page 322	



REMS dry diamond core drilling crowns LS

For REMS Picus DP and other suitable makes

High quality dry diamond core drilling crowns. Laser welded. Especially for dry drilling with core drilling machines with micro-pulse technology, e.g. REMS Picus DP, hand held or with drill stand. Ideal for universal applications in steel-reinforced concrete, masonry and many types of material.

Concrete, steel-reinforced concrete, aggregate concrete, brick, clinker, all kinds of masonry, natural stone, asphalt, all kinds of screed and other \varnothing 32 – 202 mm

REMS dry diamond core drilling crowns LS – Laser welded, high temperature-resistant. Especially for dry drilling with core drilling machines with micro-pulse technology. Versatile for many types of material. Ideal for plumbers.

Universally usable for many materials, hand held or with drill stand.

Single connecting thread UNC 1 1/4 female. Drilling depth 320 mm.

Specially developed, high quality diamond segments with high diamond percentage and special bonding, for excellent drilling performance and very long life. Ideal for universal applications in steel-reinforced concrete and masonry.

Diamond segments with diamonds positioned in the bonding agent. For fast, easy and quiet drilling. Inductively soldered on fully automatic soldering machines for constant high quality of the soldered connection. Drilling tubes with soldered diamond segments can be resoldered by simple hard soldering.

Light loosening ring, for light loosening of the diamond core crowns, as accessory.

Driven by a REMS Picus DP drive unit and suitable drive units of other makes with UNC 1 1/4 outer connecting thread.

Use REMS Pull 2 M for high-performance extraction of drilling dusts from the drilling gap during dry drilling (page 322). The REMS Pull 2 M safety vacuum cleaner is certified for extracting health hazardous dusts of dust class M.

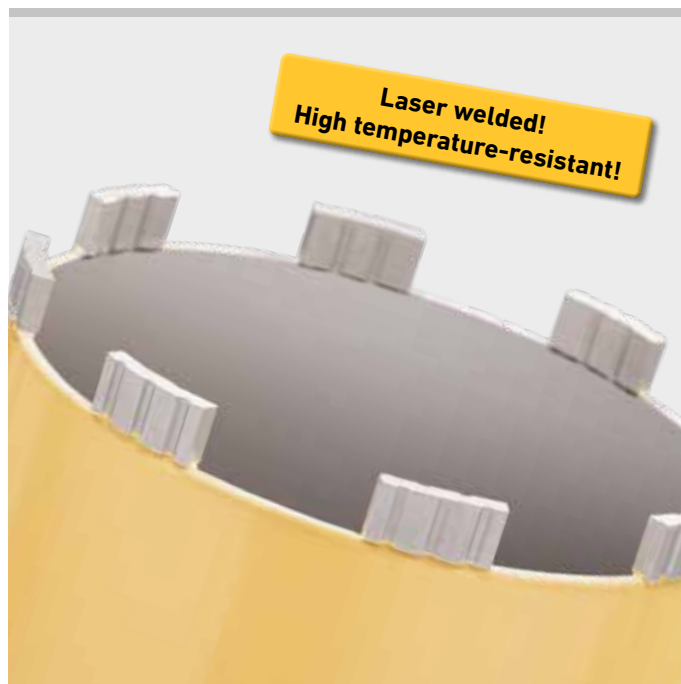

Supply format

REMS dry diamond core drilling crowns LS. Laser welded, high temperature-resistant. Especially for dry drilling with core drilling machines with micro-pulse technology, e.g. REMS Picus DP, hand held or with drill stand. For many materials, e.g. concrete, steel-reinforced concrete, all kinds of masonry, natural stone, asphalt, all kinds of screed. Connecting thread UNC 1 1/4 female. Drilling depth 320 mm. In a carton.

\varnothing × drilling depth × connection	Number of segments	Art.-No.
TDKB LS 32 × 320 × UNC 1 1/4	3	181500
TDKB LS 42 × 320 × UNC 1 1/4	4	181502
TDKB LS 52 × 320 × UNC 1 1/4	5	181504
TDKB LS 62 × 320 × UNC 1 1/4	5	181506
TDKB LS 72 × 320 × UNC 1 1/4	6	181508
TDKB LS 82 × 320 × UNC 1 1/4	6	181510
TDKB LS 92 × 320 × UNC 1 1/4	6	181512
TDKB LS 102 × 320 × UNC 1 1/4	7	181514
TDKB LS 112 × 320 × UNC 1 1/4	7	181516
TDKB LS 122 × 320 × UNC 1 1/4	8	181532
TDKB LS 127 × 320 × UNC 1 1/4	8	181518
TDKB LS 132 × 320 × UNC 1 1/4	8	181520
TDKB LS 142 × 320 × UNC 1 1/4	8	181522
TDKB LS 152 × 320 × UNC 1 1/4	8	181524
TDKB LS 162 × 320 × UNC 1 1/4	9	181526
TDKB LS 182 × 320 × UNC 1 1/4	9	181528
TDKB LS 202 × 320 × UNC 1 1/4	10	181530



Accessories

Description	Art.-No.
Light loosening ring , for light loosening of the diamond core crown	180015
Drilling crown extension 200 mm	180155
Sharpening stone for diamond core drilling crowns	079012
Single open ended wrench size 41 for UDKB	079003

Additional adapters for using REMS dry diamond core drilling crowns LS in drive machines of other makes, on request.



Diamond tipped dry drilling crowns for fast, clean drilling in all kinds of tiles. Ideal for assembly and renovation.

Ceramic, fine clay, granite, marble etc.

REMS tile drilling – for dry drilling.

Can be used universally for dry drilling without hammering in ceramic, fine clay, granite, marble and other materials. No cracking of the tiles.

No water necessary.

Special wax filling inside the dry drilling crown as a cooling lubricant, becomes liquid when heated and cools the dry drilling crown.

Simple, free-hand starting by drill aid with vacuum fastening.

Hexagon connection for 1/4" bit holders.

Drive by cordless REMS Helix 22 V VE power drill (page 108) and other electric drills/screwdrivers (speed ≥ 1,000 rpm).



Supply format

REMS tile drilling Set 6 + 8 + 10. Diamond-studded dry drilling crowns with special wax filling. For ceramic, fine clay, granite, marble and other materials. Tile drilling Ø 6, 8, 10 mm, drill aid with vacuum fastening. In blister pack.

	Art.-No.
	181700

Accessories

Description	Art.-No.
REMS tile drilling Ø 5 mm	181710
REMS tile drilling Ø 6 mm	181711
REMS tile drilling Ø 8 mm	181712
REMS tile drilling Ø 10 mm	181713
REMS tile drilling Ø 12 mm	181714
REMS tile drilling Ø 14 mm	181715
REMS Helix 22V VE , cordless drill/screwdriver, see page 108	





Compact, handy power tool for dry chasing and cutting, e.g. of concrete, steel-reinforced concrete, all kinds of masonry, natural stone, all kinds of screed. For trade and industry.

REMS Krokodil 125

Chase depth	≤ 38 mm
Chase width	≤ 43 mm
Number of diamond cutting discs	1 – 2

REMS Krokodil 180 SR

Chase depth	≤ 61 mm
Chase width	≤ 62 mm
Number of diamond cutting discs	1 – 3

REMS Universal diamond cutting discs, also for suitable drive machines of other makes, see page 321.

REMS Krokodil – chasing instead of chiselling. Full contact support plate. Multi-function electronics.

Universal use

Universal drive machine for dry chasing and cutting. Ideal for producing chases/grooves for laying pipes and electric cables in heating, sanitary and electrical installation, air-conditioning and cooling technology.

Design

REMS Krokodil 125: Compact, handy drive machine, only 5.8 kg. Robust, suitable for building site conditions. Fast, easy working, e.g. chases in masonry 500 mm long, 38 mm deep, only 25 s. Full contact support plate during the entire chasing/cutting process for guided plunge-in of the diamond cutting discs, dust-free, safe working and easy, even feed. Practical switch grip, adjustable in two positions, parallel or transversely to the machine axis and swivel handle, for optimum working position and ergonomic work. Locking of the drive shaft for easy changing of the universal diamond cutting discs. 4 spacer discs of different thicknesses according to desired chase width screws to the cutting discs in a stable block, ensure an even chase width. Continuously adjustable depth stop. Suction nozzle for connecting a dust extractor integrated into the housing.

REMS Krokodil 180 SR: Compact, handy drive machine, only 8.0 kg. Robust, suitable for building site conditions. Fast, easy working, e.g. chases in masonry 500 mm long, 61 mm deep, only 34 s. Full contact support plate during the entire chasing/cutting process for guided plunge-in of the diamond cutting discs, dust-free, safe working and easy, even feed. Practical switch handle with triple force-transmitting leverage for easy plunge-in and effective feeding. Swivel handle, for optimum working position and ergonomic work. Locking of the drive shaft for easy changing of the universal diamond cutting discs. Spacer discs of different thicknesses according to desired chase width screws to the cutting discs in a stable block, ensure an even chase width. Continuously adjustable depth stop. Suction nozzle for connecting a dust extractor integrated into the housing.

Drive

REMS Krokodil 125: Robust, powerful universal motor, 1,850 W. Load speed of the drive shaft of the cutting discs 5,000 rpm. Strong, maintenance-free gear. Connecting cable 2.3 m. Safety switch with lock.

REMS Krokodil 180 SR: Robust, powerful universal motor, 2,000 W. Load speed of the drive shaft of the cutting discs 3,300 rpm. Overheating protection by temperature monitoring of the motor's field winding with a PTC resistor (Positive Temperature Coefficient). Strong, maintenance-free gear. Connecting cable 5.7 m. Safety switch with lock. Restart protection in case of mains failure.

Speed Regulation

The electronic tachometer speed control (REMS Krokodil 180 SR) used for regulation keeps the speed constant, also under load. The speed of the cutting disc is kept at the nominal value until it meets with resistance and drops below a critical value. The drive motor stops. When the load on the drive unit is relieved again, the drill runs back up to nominal speed so that work can continue immediately at nominal speed (**Patent EP 2 085 191**). Advantage: The chasing and cutting speed (load speed) is maintained during the entire chasing and cutting process for a high chasing and cutting performance.

Multi-function electronics

Multifunction electronics with start-up current limiting for soft starting for delicate engagement of the diamond cutting discs, automatic idle speed limiting for noise reduction and preservation of the motor, overload and blocking protection for motor and gear.

Universal diamond cutting discs

Universally usable for straight chasing and cutting. Specially developed, high quality diamond segments with high diamond content and special bonding for excellent chasing/drilling performance and very long life. Optionally REMS Universal diamond cutting discs LS Turbo, laser-welded, high temperature-resistant, for fast cuts and cuts in hard materials or REMS Universal diamond cutting discs LS H-P, high-performance, laser-welded, high temperature-resistant, for fast cuts and cuts in very hard materials, with long life (page 321), metal body in accordance with EN 13236. Mounting bore \varnothing 22.23 mm.

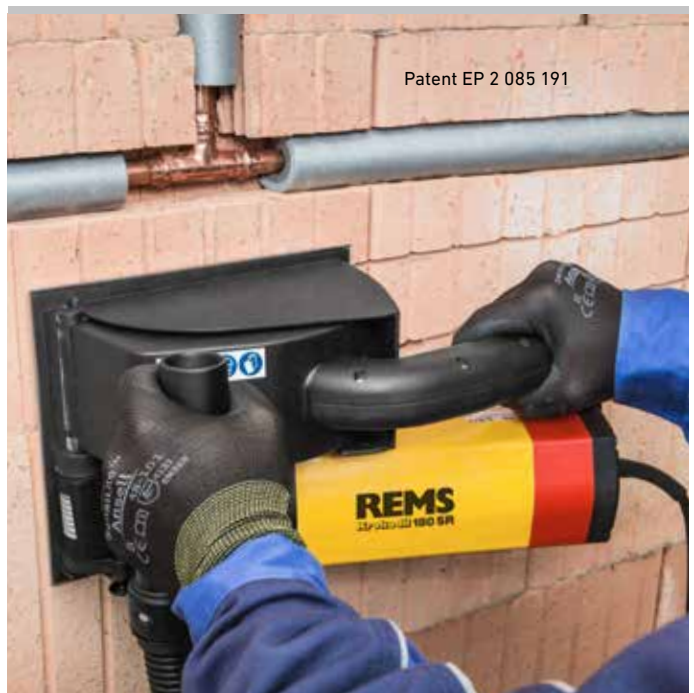

Full contact support plate during the entire chasing/cutting process for guided plunge-in of the diamond cutting discs, dust-free, safe working and easy, even feed.

Dust extraction in accordance with EN 60335-2-69

When working with mineral building materials, e.g. concrete, steel-reinforced concrete, masonry and screed, a high degree of mineral dust containing quartz is produced which is harmful to the health. Inhalation of quartz fine dust is harmful to the health. EN 60335-2-69 prescribes the use of at least one safety extractor of dust class M for the extraction of health hazardous dusts with an exposure limit/work place limit of $> 0.1 \text{ mg/m}^3$. Observe the national regulations. REMS Pull 2 M, wet and dry dust extractor, certified for extracting health hazardous dusts of dust class M (page 322).

Supply format

REMS Krokodil 125 Basic-Pack. Electric diamond chasing and cutting grinder for chasing and cutting concrete, steel-reinforced concrete, all kinds of masonry, natural stone, all kinds of screed. Chase depth 38 mm, continuously adjustable. Chase width $\leq 43 \text{ mm}$, stepped with spacer discs 3, 6, 10, 20 mm. Drive machine with drive shaft $\varnothing 22.2 \text{ mm}$, for 1 or 2 diamond cutting discs in accordance with EN 13236, $\leq \varnothing 125 \text{ mm}$, with maintenance-free gear, 230 V, 50–60 Hz, 1,850 W universal motor. Multifunction electronics with soft start, idling speed limiting, overload protection. Connecting cable 2.3 m. Safety switch with lock. Load speed 5,000 rpm. Suction nozzle for connecting an extractor/dust extractor. Pin wrench size 13. In sturdy carrying case.

	Art.-No.	
	185010	

Other voltages on request.



Supply format

REMS Krokodil 180 SR Basic-Pack. Electric diamond chasing and cutting grinder with speed regulation. For chasing and cutting concrete, steel-reinforced concrete, all kinds of masonry, natural stone, all kinds of screed. Chase depth 61 mm, continuously adjustable. Chase width $\leq 62 \text{ mm}$, stepped with spacer discs 3, 6, 10, 20 mm. Drive machine with drive shaft $\varnothing 22.2 \text{ mm}$, for 1, 2 or 3 diamond cutting discs in accordance with EN 13236, $\leq \varnothing 180 \text{ mm}$, with maintenance-free gear, 230 V, 50–60 Hz, 2,000 W universal motor. Multifunction electronics with soft start, idling speed limiting, overload protection, overheating protection. Restart protection in case of mains failure. Connecting cable 5.7 m. Safety switch with lock. Load speed 3,300 rpm. Suction nozzle for connecting an extractor/dust extractor. Pin wrench size 13. In sturdy steel case.

	Art.-No.	
	185011	

Other voltages on request.



Accessories

Description	Art.-No.	
REMS Krokodil 125 drive unit	185000	
REMS Krokodil 180 SR drive unit	185001	
REMS Universal diamond cutting disc LS-Turbo $\varnothing 125 \text{ mm}$, laser-welded, high temperature-resistant, for fast cuts and cuts in very hard materials, with metal body in accordance with EN 13236	185021	
REMS Universal diamond cutting disc LS H-P $\varnothing 125 \text{ mm}$, high-performance, laser-welded, high temperature-resistant, for fast cuts and cuts in very hard materials, long life, with metal body in accordance with EN 13236.	185022	
REMS Universal diamond cutting disc LS-Turbo $\varnothing 180 \text{ mm}$, laser-welded, high temperature-resistant, for fast cuts and cuts in very hard materials, with metal body in accordance with EN 13236	185026	
REMS Universal diamond cutting disc LS H-P $\varnothing 180 \text{ mm}$, high-performance, laser-welded, high temperature-resistant, for fast cuts and cuts in very hard materials, long life, with metal body in accordance with EN 13236.	185027	
Chasing chisel for removing the ridge after chasing	185024	
Case with inlay for REMS Krokodil 125	185054	
Steel case	185058	
REMS Pull 2 L / M , dry and wet extractors, see page 322		



Powerful, electric dry and wet extractor with automatic filter cleaning. For commercial use in trade and industry.

For extraction of dusts, dirt and liquids.

Ideal for dust extracting when chasing, cutting, drilling, core drilling and grinding.

Certified as extractor and dust extractor for extracting health hazardous dusts.

Ideal for extracting drilling sludge during core drilling.

REMS Pull 2 L

Dust class in accordance with EN 60335-2-69 L

Exposure limit/work place limit > 1 mg/m³

Penetration level ≤ 0.1 %

REMS Pull 2 M

Dust class in accordance with EN 60335-2-69 M

Exposure limit/work place limit > 0.1 mg/m³

Penetration level ≤ 0.1 %

REMS Pull 2 – for dry and wet suction.

Constantly high suction performance

by permanent automatic filter cleaning.

Certified for extracting health hazardous dusts.

Universal use

Powerful, handy extractor for dry and wet suction. For extraction of dusts, dirt and liquids. Excellently suited for dust extracting when chasing, cutting, drilling, core drilling and grinding. Certified as an extractor and dust extractor for extracting health hazardous dusts of dust class L or M in accordance with EN 60335-2-69. For commercial use in trade and industry.

Design

Compact, handy design. REMS Pull 2 L only 13.5 kg, REMS Pull 2 M only 14.2 kg. Light and manoeuvrable by rubber wheels and steerable castors, lockable by castor with brake. Large tank capacity 31 l, filling volume for liquids 17 l. On/Off switch with selection without filter cleaning or with filter cleaning with a 15 s or 60 s cycle. Adapter for connecting a power tool to the vacuum cleaner. Flexible 4 m, electrically conductive suction hose (Pull M), ergonomically angled handle, 2 pluggable, chrome-plated metal suction pipes 0.5 m for adapting the suction pipe length. Wide wet/dry surface attachment 300 mm with rubber-coated castors, optionally brush strips for extracting dusts and dirt or rubber lips for extracting liquids. Joint attachment for confined spaces. Large working radius by long 7.5 m connecting lead. Holders for connecting lead, suction hose, metal suction tubes and accessories integrated into the extractor. Practical handle for easy transport. Integrated fittings for fixing a REMS L-Boxx system case.

REMS Pull 2 M is suitable and certified for the extraction of health hazardous dusts of dust class M in accordance with EN 60335-2-69, with electronic flow monitoring, selector switch for adapting the suction power to different suction hose diameters (21, 27, 32, 35, 40 mm) and stopper for the suction hose connection nozzle.

Permanent automatic filter cleaning

REMS Pull 2 L and REMS Pull 2 M with innovative, patented, automatic filter cleaning, prevents clogging of the filter with dust, especially effective in fine dust applications. The flat pleated filter is cleaned automatically by targeted, powerful shots of air every 15 s or 60 s depending on the setting. The suction force remains constantly high during cleaning. Patented flat folded filter system.

Drive

Robust, powerful bypass motor, 1,200 W, with high-power turbine. High suction power, continuously adjustable up to an air rate ≤ 143 m³/h, for optimum adaptation to the suction surface and the extracted product.

Automatic switch-off

Filling level limiting with automatic switch off on reaching the maximum liquid filling level when extracting electrically conductive liquids.

Automatic power tool on/off

Appliance socket for power tools up to 2,200 W, with electronic automatic on/off integrated into the extractor. The extractor switches on/off automatically when the power tool is switched on/off. For convenient working.

Anti-static system (REMS Pull 2 M)

Static charge is dissipated to the earthed upper section of the extractor by electrically conductive metal suction pipes, electrically conductive handle E, electrically conductive suction hose E and electrically conductive suction hose connection nozzle.



Info



Certified extractor and dust extractor for extracting health hazardous dusts in accordance with EN 60335-2-69.



Extraction of health hazardous dusts when chasing and cutting:
REMS Pull 2 M Set



Extraction of health hazardous dusts when dry drilling:
REMS Pull 2 M Set D

Dust extraction in accordance with EN 60335-2-69

When working with mineral building materials, e.g. concrete, steel-reinforced concrete, masonry and screed, a high degree of mineral dust containing quartz is produced which is harmful to the health. Inhalation of quartz fine dust is harmful to the health. EN 60335-2-69 prescribes the use of at least one safety extractor of dust class M for the extraction of health hazardous dusts with an exposure limit/work place limit of > 0.1 mg/m³. Observe the national regulations.

Water extraction

PES flat folded filter required for extraction of water. Use wet filter bag or polythene bag if necessary. Wet filter bags separate the water from the sucked up solids when extracting dirty water. Polythene bags simplify disposal of the dirt and prevent dirt from collecting in the tank.



Extraction of drilling sludge when wet drilling with REMS drill stands:
REMS Pull 2 L Set W

Supply format

REMS Pull 2 Set. Electric dry and wet extractor for commercial use. For extraction of dusts, dirt and liquids. Ideal for dust extracting when chasing, cutting, drilling, core drilling and grinding. Certified extractor and dust extractor for extracting health hazardous dusts in accordance with EN 60335-2-69¹⁾. Bypass motor 230 V, 50–60 Hz, 1,200 W. On/Off switch with selection for automatic filter cleaning. Suction power switch for continuous adjustment of the air flow ≤ 143 m³/h. Filling level limiting with automatic switch-off for wet suction. Automatic filter cleaning. Appliance socket for power tools up to 2,200 W, with electronic automatic on/off. Large tank capacity 31 l, filling volume for liquids 17 l. Mobile, 2 wheels, castor/castor with brake. Connecting cable 7.5 m. 1 felt filter bag, 1 flat pleated filter PES. Flat suction attachment wet/dry 300 mm with rollers, brush strips, rubber lips. Joint attachment. Pull 2 suction hose/power tool adapter. Integrated holders for connecting cable, suction hose and accessories. In a box.

Description	Version	Art.-No.
Pull 2 L Set	Dust class L. Exposure limit/work place limit > 1 mg/m ³ , penetration level ≤ 0.1 %, 2 metal suction pipes 0.5 m each, handle, 4 m suction hose, suction hose connection nozzle.	185600
Pull 2 L Set W	REMS Pull 2 L set with water suction device. Ideal for extraction of drilling sludge when wet drilling with REMS drill stands.	185603
Pull 2 M Set	Dust class M. Exposure limit/work place limit > 0.1 mg/m ³ , penetration level ≤ 0.1 %. Electronic volume flow monitor with acoustic signal. Selector switch for suction hose diameter. Stopper for the suction hose connection nozzle. Antistatic system with 2 electrically conductive metal suction pipes 0.5 m each, E handle, 4 m E suction hose, suction hose connection nozzle. 1 polythene bag.	185601
Pull 2 M Set D	REMS Pull 2 M Set including suction rotor for dust extraction. Ideal for extracting health hazardous dusts when dry drilling with REMS Picus S1, Picus SR, Picus S3 etc.	185604

Extraction of health hazardous dusts when chasing and cutting:
REMS Pull 2 L Set



REMS Pull 2 L Set



Safety extractor of dust class L



REMS Pull 2 M Set



Safety extractor of dust class M

Accessories

Description	Art.-No.
Felt filter bag (pack of 5) , polyester felt, 3-ply, tear-proof, for wet and dry extraction, M-certified, for normal dirt, fine dusts, abrasive dusts, wet dirt	185511
Wet filter bag (pack of 5) , paper-polyester woven felt, tear-proof, for wet and dry extraction, for abrasive dusts, wet dirt, liquids	185512
Polythene bag (pack of 10) , for wet and dry extraction of non-health hazardous dusts, for normal dirt, fine dusts, abrasive dusts, wet dirt, liquids. Prevents soiling of the tank.	185513
Flat folded filter PES , polyester, nano-coated, 1 piece, water-resistant, non-rotting, washable with water. For wet and dry extraction, M-certified	185515
Suction rotor for dust extraction see page 309	180160
Water suction device see page 309	183606

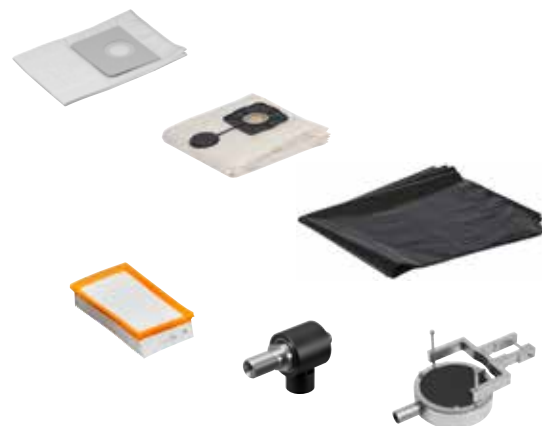

¹⁾ Observe the national regulations for the collection and disposal of health hazardous dusts.



PRESS

Drying
Dehumidifying
Aeration and deaeration



**Air dehumidifier/
building dryer**

326



Construction ventilators

328

Powerful, highly efficient air dehumidifiers/building driers for drying rooms, e.g. after mains water damage, flooding, dehumidification of damp cellar rooms etc. and for fast drying of concrete, masonry, plaster and screed for example. For commercial use in trade and industry.

REMS Secco 50

Dehumidification rate $\leq 50 \text{ l}/24 \text{ h}$
Air volume $\leq 265 \text{ m}^3/\text{h}$

REMS Secco 80

Dehumidification rate $\leq 80 \text{ l}/24 \text{ h}$
Air volume $\leq 850 \text{ m}^3/\text{h}$

REMS Secco – for drying and dehumidification.

Universal use

Powerful, highly efficient air dehumidifiers/building driers for drying rooms, e.g. after mains water damage, flooding, dehumidification of damp cellar rooms etc. and for fast drying of concrete, masonry, plaster and screed for example. For commercial use in trade and industry.

Design Secco 50

Compact, handy construction in robust, plastic housing. Weight 21 kg. Large air extraction areas with washable air filter. Electronic hygrostat for regulating the desired humidity: Switches off automatically on reaching the nominal humidity, switches back on automatically when humidity rises. Upward air outlet for optimum air circulation. Condensation draining into an internal 7.7 l condensation tank, hose extendible from the rear, for draining condensation into a tank to be provided or directly into the drain system. Automatic switch-off with switch-off signal when using the internal 7.7 litre condensation tank on reaching the maximum condensation filling level. Operating hours counter and electricity meter, e.g. for reporting to the damage regulator/customer, as an accessory. Sturdy plastic housing with castors for easy transport.

Design Secco 80

Compact, handy construction in robust, powder-coated sheet steel housing. Weight 51 kg. Large air extraction areas with washable air filter. Electronic hygrostat for regulating the desired humidity: Switches off automatically on reaching the nominal humidity, switches back on automatically when humidity rises. Side air outlet for optimum air circulation. Hose for draining condensation into an internal 11.5 l condensation tank (accessory), extendible at the side, for draining condensation into a tank to be provided or directly into the drain system. On/Off switch for operation with and without internal 11.5 litre condensation tank. Automatic switch-off with switch-off signal when using the internal 11.5 litre condensation tank on reaching the maximum condensation filling level. Operating hours counter and electricity meter, e.g. for reporting to the damage regulator/customer. Device socket for detachable connecting cable. Practical compartment for the connecting cable during transport. Sturdy, mobile tubular steel frame with large castors for easy transport, also over steps. Easy glide down and pull-up of the machine over the back of the tubular steel frame, e.g. from and onto the loading platform of a vehicle.

Chiller unit Secco 50

High dehumidification rate by high quality chiller unit with highly efficient rotation compressor and high-performance capacitor motor 230 V, 760 W with electronic thawing system, for continuous operation. Very quiet running, also suitable for living rooms. Dehumidification rate $\leq 50 \text{ l}/24 \text{ h}$, air volume $\leq 265 \text{ m}^3/\text{h}$. High quality coolant R-290.

Chiller unit Secco 80

High dehumidification rate by high quality chiller unit with highly efficient rotation compressor and high-performance condensation motor 230 V, 680 W with automatic hot-gas thawing system, for continuous operation. Very quiet running, also suitable for living rooms. Dehumidification rate $\leq 80 \text{ l}/24 \text{ h}$, air volume $\leq 850 \text{ m}^3/\text{h}$. High quality coolant R-290.

Electronic control unit Secco 50

Large, illuminated control panel with clear display of actual and nominal humidity, operating state of the chiller unit, thawing function. Keys for setting the desired humidity in 5 % steps between 30 % and 90 % as well as for setting the continuous operation. Keys for 2 fan speeds. Key for timer. Memory function saves the settings for automatic continuation of operation after a power failure.

Electronic control unit Secco 80

Illuminated 3" display with LCD technology, 70 mm screen diagonal, with clear display of actual and nominal humidity, operating hours, operating state of the chiller unit, the thawing function, the compressor protection function and the operating position for internal 11.5 litre condensation tank. Keys for setting the desired humidity in 1 % steps between 30 % and 90 % as well as for setting the continuous operation. Memory function saves the settings for automatic continuation of operation after a power failure.

Condensation tank with pump Secco 50 and Secco 80

Condensation tank with condensation pump for pumping the condensation out of the condensation tank into a higher tank or a wash basin, as an accessory.



Exhaust air set Secco 80

Generously dimensioned exhaust air hose Ø200 mm, 10 m long, with metal fastening eyes for hanging up on site, with connecting flange, for distribution of the exhaust air in the room, for dehumidifying cavities, e.g. above intermediate ceilings and for additional blowing of wet surfaces (accessory).

REMS Orkan

For supporting electric dehumidifiers/construction driers. For faster drying and dehumidification after floods and water mains damage, it is an advantage to improve the air exchange with electric construction ventilators REMS Orkan (page 328).

Supply format

REMS Secco 50 Set. Electric air dehumidifier/building dryer for commercial use. For drying rooms, dehumidifying cellars etc. and drying concrete, masonry, plaster and screed. Chiller unit with rotation compressor and capacitor motor 230V, 50 Hz, 760W, with automatic thawing system, for continuous operation. Very quiet running. Dehumidification rate ≤ 50 l/24 h, air volume ≤ 265 m³/h. Electronic control unit with large, illuminated display and memory function. Electronic humidity switch. Air filter. Internal 7.7 l condensation tank. In sturdy plastic housing with casters. In a carton.

	Art.-No.	
	132011	

Other voltages on request.

Supply format

REMS Secco 80 Set. Electric air dehumidifier/building dryer for commercial use. For drying rooms, dehumidifying cellars etc. and drying concrete, masonry, plaster and screed. Chiller unit with rotation compressor and capacitor motor 230V, 50 Hz, 680W, with automatic hot-gas thawing system, for continuous operation. Very quiet running. Dehumidification rate ≤ 80 l/24 h, air volume ≤ 850 m³/h. Electronic control unit with illuminated 3" display and memory function. Electronic hygrostat, operating hours counter, electricity meter. Air filter. In a sturdy sheet steel housing on a mobile tubular steel frame with large castors. In a carton.

	Art.-No.	
	132010	

Other voltages on request.

Accessories

Description	Art.-No.	
11.5 litre condensation tank Secco 80 for discharge of condensation in the sheet steel housing. For REMS Secco 80.	132100	
Exhaust air set Secco 80 , consisting of exhaust air hose Ø200 mm, 10 m long, with metal fastening eyes for hanging up on site, with connecting flange, for distribution of the exhaust air in the room, for dehumidifying cavities, e.g. above intermediate ceilings and for additional blowing of wet surfaces.	132104	
Condensation tank with Secco 50 pump for pumping the condensation out of the condensation tank into a higher tank or a wash basin. Pumping height ≤ 2 m. For REMS Secco 50.	132129	
Condensation tank with Secco 80 pump for pumping the condensation out of the condensation tank into a higher tank or a wash basin. Pumping height ≤ 2 m. For REMS Secco 80.	132121	
Operating hours counter and electricity meter , e.g. for reporting to the damage regulator/customer. For REMS Secco 50 and others.	132132	
REMS Detect W , dielectric moisture measuring device for non-destructive moisture measurement in building materials, e.g. concrete, masonry, plaster, wood. In a case.	132115	
REMS Orkan , electric construction ventilator, see page 328.		



Info



Info



REMS Orkan 1360/2050

Electric construction ventilator

Powerful, highly efficient electric construction ventilator for supporting dehumidifiers/construction driers after floods and water mains damage. Ideal for aeration and deaeration of rooms, spaces, shafts and cavities as well as aeration and wind cooling of machines, marquees, event halls. For supporting the exchange of air in damp, musty cellar rooms and for speeding up the drying of concrete, masonry, plaster and screed, for example. For commercial use in trade and industry.

REMS Orkan 1360

Air volume	1360 m ³ /h
Power	145 W

REMS Orkan 2050

Air volume stage I	1740 m ³ /h
Power stage I	355 W
Air volume stage II	2050 m ³ /h
Power stage II	450 W

REMS Orkan – for aeration.

Universal use

Powerful, highly efficient construction ventilator for supporting dehumidifiers/construction driers after floods and water mains damage. Ideal for aeration and deaeration of rooms, spaces, shafts and cavities as well as aeration and wind cooling of machines, marquees, event halls. For supporting the exchange of air in damp, musty cellar rooms and for speeding up the drying of concrete, masonry, plaster and screed, for example. For commercial use in trade and industry.

Design Orkan 1360

Axial fan in sturdy plastic housing of rotation-moulded polyethylene for a long life. Compact, handy design, weighing only 6.8 kg, with low-noise, single-phase capacitor motor 230 V, 145 W, with practical handle for carrying. Generated air volume 1,360 m³/h.

Large-diameter exhaust air and suction hose, Ø 200 mm, 10 m long, e.g. for extracting air from rooms, spaces, shafts and cavities, for discharging sucked-in air or dusts to the outside and for inflating bouncy castles, hot-air balloons, for example, as an accessory. An exhaust and suction hose can be fitted to the aeration or deaeration side of the construction ventilator as the situation requires. Dust sack, Ø 200 mm, 2,980 mm long, washable, for collecting coarse and fine dusts up to dust class M, as an accessory.

Design Orkan 2050

Turbo radial fan with 2 air volume stages, in sturdy plastic housing of rotation-moulded polyethylene for a long life. Compact, handy design, weighing only 10 kg, with low-noise, single-phase capacitor motor 230 V, 355/450 W, with practical handle for carrying. Horizontal air outlet, adjustable to below 45° or vertical by appropriate resting surfaces on the plastic housing. Generated air volume in 2 selectable stages 1,740/2,050 m³/h. Especially suitable for speeding up drying of concrete, masonry, plaster and screed, for example.



Supply format

REMS Orkan 1360. Electric construction ventilator for commercial use. For aeration and deaeration of rooms, spaces, shafts and cavities as well as aeration and wind cooling of machines, marquees, event halls. For supporting the exchange of air in damp, musty cellar rooms, for supporting the drying of, e.g., concrete, masonry, plaster and screed and for inflating bouncy castles, hot air balloons, for example. Capacitor motor 230V, 50 Hz, 145W, for continuous operation. Very quiet running. Air volume 1,360 m³/h. In a sturdy plastic housing. In a carton.

Art.-No.
132300

Other voltages on request.



Info

Supply format

REMS Orkan 2050. Electric construction ventilator for commercial use. For aeration and deaeration of rooms, spaces, shafts and cavities as well as aeration and wind cooling of machines, marquees, event halls. For supporting the exchange of air in damp, musty cellar rooms. Especially also for drying of, e.g., concrete, masonry, plaster and screed. Capacitor motor 230V, 50 Hz, 355/450 W, for continuous operation. Very quiet running. Air volume 1,740/2,050 m³/h. In a sturdy plastic housing. In a carton.

Art.-No.
132301

Other voltages on request.



Info

Accessories

Description	Art.-No.
Exhaust air and suction hose, Ø 200 mm, 10 m long, for extracting air from rooms, spaces, shafts and cavities, for discharging sucked-in air or dusts to the outside and for inflating bouncy castles, hot-air balloons, for example. For REMS Orkan 1360.	132307
Dust sack, Ø 200 mm, 2,980 mm long, washable, for collecting coarse and fine dusts up to dust class M. For REMS Orkan 1360.	132308
Operating hours counter and electricity meter, e.g. for reporting to the damage regulator/customer. For REMS Orkan and others.	132132
REMS Detect W, dielectric moisture measuring device for non-destructive moisture measurement in building materials, e.g. concrete, masonry, plaster, wood. In a case.	132115
REMS Secco, electric air dehumidifiers/building driers, see page 326.	



Index

A

Aeration and deaeration.....	325
Akku-Press 14 V.....	188–189
Akku-Press 14 V ACC.....	190–191
Akku-Press 22 V ACC.....	192–193
Akku-Press 22 V ACC Connected.....	194–195
Akku-Press XL 45 kN 22 V ACC.....	196–197
Amigo.....	25
Amigo 2.....	26
Amigo 2 Compact.....	27
Amigo 22 V.....	28–29
Amigo E.....	24
Aquila 3B.....	105
Aquila WB.....	105
Assembling.....	103
Attachment heads for button dies / intermediate rings / guide bushings.....	31
Axial Press Jointing.....	241
Ax-Press 25 22 V ACC.....	244–245
Ax-Press 25 L 22 V ACC.....	244–245
Ax-Press 30 22 V.....	242
Ax-Press HK / H.....	243

B

Bending.....	127
Bending formers and back formers.....	143
Blitz.....	264
Brazing solder ISO 17672-CuP 179.....	265
Butt welding machine.....	292–295
Butt welding units.....	296

C

Cable shear.....	239
Calc-Push.....	116
CamScope HD.....	273
CamSys.....	274–275
CamSys 2.....	276–278
Cat 22 V VE.....	62–63
Catch S.....	104
Catch W.....	104
Cat VE.....	61
Cento.....	86–87
Cento 22 V.....	88–89
Chain pipe vice.....	105
Chain pipe vice for workbench.....	105
Chamfering.....	75
Chasers.....	44
Chasers and Holders.....	44
Circular pipe sawing machine.....	72
CleanH.....	119, 123
Cleaning.....	113
Cleaning and preservation unit for heating systems.....	119, 123
Cleaning pads.....	262
CleanM.....	123
Cobra 22/32.....	284–287
Collum.....	51
Collum 22 V.....	52–53
Compression heads.....	246–247
Confirmation of suitability.....	237
Contact 2000.....	263
Cordless axial press 13 kN with automatic return.....	244–245
Cordless axial press 20 kN with automatic return.....	244–245
Cordless axial press 30 kN.....	242
Cordless die stock with quick-change die heads.....	28–29
Cordless drain cleaning machine.....	282–283
Cordless LED flood light.....	111
Cordless pipe cutter.....	85
Cordless pipe cutting machine.....	88
Cordless pipe expander 20 kN with automatic return.....	252–253
Cordless pipe reciprocating saw.....	68–69
Cordless power drill/screwdriver.....	108–109
Cordless radial press 22 kN with automatic circuit control.....	147–151
Cordless radial press 32 kN with automatic circuit control.....	190–191
Cordless radial press 32 kN with automatic circuit control and pressure monitoring.....	192–193
Cordless radial press 32 kN with Connected functionality via Wi-Fi radio standard and OLED display.....	194–195
Cordless radial press 32 kN with switch-off signal.....	188–189
Cordless radial press XL 45 kN with automatic circuit control.....	196–197
Cordless roll grooving machine.....	52–53
Cordless tube bender.....	132–133, 140–141
Cordless universal reciprocating saw.....	62–63
Cropping tongs.....	239
Cropping tongs Mini.....	181
Curvo.....	136–137
Curvo 22 V.....	140–141
Curvo 50.....	138–139
Cut 110 Cu-INOX.....	97
Cut 110 P.....	96
Cutter wheels.....	83
Cutting.....	75
Cu-Vlies.....	262

D

Deburring.....	75
Dehumidifying.....	325
Diamond chasing and cutting machine.....	299
Diamond chasing and cutting machines.....	320–321
Diamond core drilling.....	299
Dies.....	30, 40
Disinfecting.....	113
Disinfection unit for drinking water installations.....	119, 123
Drain cleaner for manual and electric operation.....	280
Drill stands.....	308
Dry and wet extractor.....	322–323
Dry diamond core drilling crowns LS.....	317
Drying.....	325
DueCento.....	90–91

E

Eco-Press.....	182
Electric air dehumidifiers/building driers.....	326–327, 329
Electric construction ventilator.....	328–329
Electric decalcifying pump.....	116
Electric diamond core drilling machine.....	300–303, 306–307
Electric diamond core drilling machine with micro-pulse technology.....	314–315
Electric diamond core drilling machine with speed regulation.....	304–305
Electric die stock with quick-change die heads.....	24–27
Electric drain cleaning machine.....	281
Electric filling and flushing unit.....	124–125
Electric LED flood light.....	110
Electric pipe and drain cleaning machines.....	284–285
Electric pipe and tube bender.....	136–139
Electric pipe cutter.....	84
Electric pipe freezing unit.....	269
Electric pressure testing pump.....	115
Electric radial press 32 kN.....	183
Electric reciprocating pipe saws.....	64–65
Electric sleeve welding unit.....	290
Electric soldering pliers.....	262
Electric soldering unit.....	263
Electric tube expander.....	258–259
Electric tube extractor.....	257, 259
Electro-hydraulic pipe expander 34 kN with automatic return.....	254
Electro-hydraulic radial press 32 kN with automatic retraction.....	185
Electro-hydraulic radial press 32 kN with switch-off signal.....	184
Electro-hydraulic radial press XL 32 kN with automatic retraction.....	186
Electronic camera inspection system.....	274–277
Electronic flushing and pressure testing unit with compressor.....	120–123
Electronic flushing unit with compressor.....	117–119
EMSG 160.....	290
Endoscope camera.....	272–273
E-Push 2.....	115
Eskimo.....	268
Eva.....	22
Expander heads P.....	255
Expander heads P-CEF.....	255
Expanding.....	249
Ex-Press 22 V ACC.....	252–253
Ex-Press Cu.....	250
Ex-Press H.....	251
Ex-Press P.....	251
Extracting.....	249

F

Filling.....	113
Flushing.....	113
Folding work bench.....	72–73
Folding work benches.....	106
Freezing.....	267
Frigo 2 F-Zero.....	269

H

Hand die stock with quick-change die heads.....	22
Hand pressure testing pump.....	114
Hand tube bender.....	142
Hand tube expander.....	250–251
Hand tube extractor.....	256
Helix 22 V VE.....	108–109
Herkules.....	107
Hold-Harmless and Indemnification Agreement.....	238
Hot Dog 2.....	262
Hurrican.....	257
Hurrican H.....	256
Hydro-Swing.....	130–131
Hydro-Swing 22 V.....	132–133

I

Inner pipe deburrer.....	99
--------------------------	----

J

Jumbo.....	106
------------	-----

Index

K

Krokodil 125/180 SR 320–321

L

Lot Cu 3 265
Lot P6 265
Lumen 2800 22V 111
Lumen 5000/7000/10000 110

M

Machine cleaner 123
Macho 264
Magnum RG 54–55
Magnum (up to 2") 34–35
Magnum (up to 3") 36–37
Magnum (up to 4") 38–39
Manual axial press 243
Manual radial press 182
Material supports 107
Mini-Cobra 280
Mini-Cobra S 281
Mini-Cobra S 22V VE 282–283
Mini-Press 14V ACC 147
Mini-Press 22V ACC 148–149
Mini-Press S 22V ACC 150–151
MiniScope 272
MSG 291
Multi-Push S 117–119
Multi-Push SL/SLW 120–123

N

Nano 84
Nano 11 V 85
Nippelfix 48
Nippelspanner 48
NoCor 119, 123

O

Oil-hydraulic hand pipe bender 130–131
Oil-hydraulic pipe bender 134–135
One-hand axial press 243
One-hand pipe expander 251
One-hand pipe shears 92–94
One-hand pipe shears with ratchet feed 95
Orkan 1360/2050 328–329
Outer-inner pipe deburrer 100–101
Outer-inner tube deburrer 99

P

Paste Cu 3 265
Perox Color 119, 123
Picus DP 314–315
Picus S1 300–301
Picus S2/3,5 306–307
Picus S3 302–303
Picus SR 304–305
Pipe and Drain cleaning 271
Pipe and Drain inspection 271
Pipe chamfering tools 98
Pipe cutter 82
Pipe cutters 76–81
Pipe cutting and pipe chamfering tool 96
Pipe cutting machine 86–87, 90
Pipe cutting tool 97
Pipe freezer 268
Pipe shears with ratchet feed 95
Pipe splitter 82
Plastic Pipe Welding 289
Pneumatic reciprocating pipe saw 66
Portable pipe workstation with chain pipe vice 105
Power-Ex-Press P-CEF ACC 254
Power-Press 184
Power-Press ACC 185–186
Power-Press SE 183
Preserving 113
Pressing rings 152–180, 198–235
Pressing tongs 198–235
Pressing tongs Mini 152–180
Pressure testing 113
Pull 2 L / M 322–323
Pull-Push 280
Puma VE 60
Push 114
Python 134–135

Q

Quick-change die heads 30
Quick-change die heads S 23

R

Radial Press Jointing 145
RAG 98
RAS Cu 79–80
RAS Cu-INOX 77–78
RAS P 80–81
RAS P/SW 45/L 82
RAS St 76
RAS W INOX 82
Reciprocating saws 58–59
REG 3–35 99
REG 8–35 100
REG 10–42 100
REG 10–54 101
REG 10–54 E 101
REG St ¼–2" 99
REG Universal 99
Roll Grooving 21
Roll grooving attachment 50
Roll grooving machine 51, 54–55
ROS P 94–95
ROS P 26/SW 35 S 93
ROS PEX 94
ROS P flex 92

S

Sanitol 49
Saw blades 71
Sawing 57
Secco 50/80 326–327
Single-hand tube bender 128–129
Sinus 142
Sleeve welding units 291
Soft solder paste of solder powder Sn97Cu3 according to ISO 9453:2014 and flux 3.1.1.C, EN 29454-1:1994 265
Soft solder Sn97Cu3, ISO 9453:2014 265
Solar-Push 124–125
Soldering 261
Special saw blades 70
Spezial 49
SSG 296
SSM 160KS 293
SSM 160RS 292
SSM 250KS 294
SSM 315RF 295
Suction and pressure cleaning device 280
Swedish pattern wrench 'S' 104
Swing 128–129

T

Thread-cutting oil 49
Threading 21
Threading machine 32–39, 42–43, 46–47
Thread tables 45
Tiger 22V VE 68–69
Tiger pneumatic 66
Tiger /VE/SR 64–65
Tile drilling 318
Tornado 32–33
Turbo Cu-INOX 72
Turbo K 73
Turbo soldering torch acetylene 264
Turbo soldering torch propane 264
Twist 258
Twist/Hurrican 259

U

Unimat 75 42–43
Unimat 77 46–47
Universal circular metal sawing machine with automatic cooling lubricant unit 73
Universal deburrer 99
Universal diamond core drilling crowns 310–311
Universal diamond core drilling crowns LS 312–313
Universal electric reciprocating saw 60–61
Universal saw blades 70

V

V-Jet H 119, 123
V-Jet TW 119, 123

W

Water pump pliers 104
Wet and dry suction 299

List of articles

Art.-No.	RG	VE	Page	Art.-No.	RG	VE	Page	Art.-No.	RG	VE	Page	Art.-No.	RG	VE	Page
578700	Z		158	581110	Z		143	751050	Z		43, 47	759363	S		44
578702	Z		158	581130	Z		143	751060	Z		43, 47	759364	S		44
578704	Z		158	581150	Z		143	751070	Z		43, 47	759365	S		44
578706	Z		158	581180	Z		143	751080	Z		43	759366	S		44
578708	Z		158	581200	Z		143	751090	Z		43	759367	S		44
578710	Z		158	581210	Z		143	751096	Z		43	759368	S		44
578712	Z		158	581220	Z		143	751097	Z		43	759370	S		44
578714	Z		158	581230	Z		143	751098	Z		43	759371	S		44
578716	Z		165	581240	Z		143	751100	Z		43	759372	S		44
578718	Z		165	581260	Z		143	751102	Z		43	759373	S		44
578720	Z		165	581270	Z		143	751501	S		44	759374	S		44
578740	Z		171, 180	581280	Z		143	751502	S		44, 47	759375	S		44
578742	Z		171, 180	581310	Z		143	751503	S		44, 47	759376	S		44
578744	Z		171, 180	581320	Z		143	751504	S		44	759377	S		44
578746	Z		171, 180	581330	Z		143	751505	S		44	759378	S		44
579000	Z		186	581350	Z		143	751506	S		44, 47	759379	S		44
579001	Z		197	581370	Z		143	751507	S		44, 47	759380	S		44
579010	E		186	581380	Z		143	751508	S		44	759381	S		44
579012	E		186	581390	Z		143	751509	S		44	759382	S		44
579014	E		197	581400	Z		143	751510	S		44	759383	S		44
579100	Z		205, 221, 225-227, 229, 234	581410	Z		143	751511	S		44	759384	S		44
579101	Z		200-203, 205-212, 214-218, 221-229, 232, 234-235	581420	Z		143	751516	S		44	770003	U		47
579104	Z		208	581430	Z		143	751517	S		44	770004	U		47
579105	Z		208	581440	Z		143	751518	S		44	771000	Z		47
579106	Z		208	581450	Z		143	751519	S		44	771110	S		47
579107	Z		209-211, 227-228	581460	Z		143	751520	S		44	771120	S		47
579108	Z		205, 217, 221, 227-229, 234	581470	Z		143	751521	S		44	771130	S		47
579109	Z		221, 229, 234	581480	Z		143	751522	S		44	771136	S		47
579110	Z		200-203, 205-212, 214-218, 221-229, 232, 234-235	581490	Z		143	751523	S		44	771140	S		47
579111	Z		200-203, 205-212, 214-218, 221-229, 232, 234-235	581500	Z		143	751524	S		44	771160	S		47
579112	Z		232	581510	Z		143	751525	S		44	771170	S		47
579113	Z		232	581520	Z		143	751526	S		44	771180	S		47
579114	Z		232	581530	Z		143	751527	S		44	771186	S		47
579120	Z		186, 236	581540	Z		143	751528	S		44	771190	S		47
579123	Z		197, 236	582036	Z		137, 139, 141-142	751544	S		44	771210	S		47
579240	Z		186	582110	Z		139	751545	S		44, 47	771220	S		47
579600	Z		119, 123	582120	Z		139	751546	S		44, 47	771230	S		47
579601	Z		186, 197	586000	Z		137	751547	S		44, 47	771240	S		47
579603	Z		236	586012	Z		139	751548	S		44	771246	S		47
580000	Z		137, 142	586100	Z		137, 141	751549	S		44	771260	S		47
580004	Z		141	586150	Z		137, 141	751550	S		44, 47	771270	S		47
580010	E		137	590000	Z		135	751551	S		44, 47	771280	S		47
580014	E		141	590020	E		135	751552	S		44, 47	773060	Z		47
580020	E		137	590021	E		135	751557	S		44	844010	E		84
580021	E		137	590022	E		135	751558	S		44	844011	E		85
580022	E		137	590051	Z		135	751559	S		44	844045	Z		84-85
580023	E		137	590052	Z		135	751560	S		44	844050	Z		84-85
580024	E		137	590053	Z		135	751561	S		44	844051	Z		84-85
580025	E		137	590054	Z		135	751562	S		44	844510	Z		85
580026	E		137	590055	Z		135	751563	S		44	845001	M		87
580027	E		137	590056	Z		135	751564	S		44	845002	M		89
580028	E		137	590057	Z		135	751565	S		44	845003	M		87
580029	E		137	590058	Z		135	751566	S		44	845004	M		91
580030	E		137	590059	Z		135	751567	S		44	845050	Z		87, 89, 91
580031	E		137	590060	Z		135	751568	S		44	845051	Z		87, 89, 91
580033	E		137	590061	Z		135	751569	S		44	845052	Z		87, 89, 91
580034	E		137	590062	Z		135	751570	S		44	845053	Z		87, 89, 91
580035	E		137	590111	Z		135	751571	S		44	845054	Z		87
580036	E		137	590150	Z		135	753240	Z		43	845055	Z		87, 89, 91
580037	E		137	590153	Z		135	759250	S		44	845057	Z		91
580038	E		137	590160	Z		135, 139	759251	S		44	845060	Z		91
580039	E		137	731200	Z		31	759252	S		44	845110	Z		87, 89
580040	E		137	731205	Z		31	759253	S		44	845118	Z		87, 89
580051	E		141	731210	Z		31	759254	S		44	845131	Z		87
580052	E		141	731220	Z		31	759255	S		44	845218	Z		87, 89
580053	E		141	731230	Z		31	759256	S		44	845220	Z		87, 89, 91
580054	E		141	731240	Z		31	759257	S		44	845230	Z		91
580055	E		141	731250	Z		31	759258	S		44	845530	Z		87, 89
580056	E		141	731301	Z		31	759259	S		44	849006	M		72
580057	E		141	731302	Z		31	759260	S		44	849007	M		73
580058	E		141	731303	Z		31	759261	S		44	849310	Z		51, 53, 72-73, 87, 89
580059	E		141	731304	Z		31	759262	S		44	849315	Z		51, 53, 72-73, 87, 89
580060	E		141	731305	Z		31	759263	S		44	849700	Z		73
580061	E		141	731306	Z		31	759264	S		44	849703	Z		72-73
580062	E		141	731307	Z		31	759265	S		44	849706	Z		72-73
580063	E		141	731308	Z		31	759270	S		44				
580064	E		141	731309	Z		31	759271	S		44				
580065	E		141	731310	Z		31	759272	S		44				
580066	E		141	731311	Z		31	759273	S		44				
580067	E		141	731312	Z		31	759274	S		44				
580068	E		141	731320	Z		31	759275	S		44				
580069	E		141	731321	Z		31	759276	S		44				
580100	Z		139	731322	Z		31	759277	S		44				
580110	E		139	731323	Z		31	759278	S		44				
581070	Z		143	731324	Z		31	759279	S		44				
581080	Z		143	731325	Z		31	759280	S		44				
				731326	Z		31	759281	S		44				
				731700	Z		24-27, 29, 99	759282	S		44				
				750003	U		43	759330	S		44				
				750004	U		43	759360	S		44				
				751000	Z		43	759361	S		44				
				751040	Z		43, 47	759362	S		44				

REMS

www.rems.de

Head Office



Germany: REMS GmbH & Co KG
Postfach 1631 · 71306 Waiblingen · Germany
Stuttgarter Straße 83 · 71332 Waiblingen · Germany
Tel +49 7151 17 07-0 · Fax +49 7151 17 07-110
info@rems.de

Branch Offices



Denmark: REMS Scandinavia A/S
Snedkervej 1 · 4600 Køge · Denmark
Tel +45 56 63 14 00
DNK@rems.de



France: REMS SARL
2, Rue du Stade · 67250 Hoffen · France
Tel +33 388 80 44 53 · Fax +33 388 80 99 43
FRA@rems.de



Great Britain: REMS (U.K.) LIMITED
Unit 5 · Ash Industrial Estate
Flex Meadow · Harlow · Essex CM19 5TJ · U.K.
Tel +44 1279 413698 · Fax +44 1279 413704
GBR@rems.de



Italy: REMS S.R.L.
Via Sirtori, 13/D · 20017 Passirana di Rho (Milano) · Italy
Tel +39 02 9 30 21 11 · Fax +39 02 9 31 02 45
ITA@rems.de



Poland: REMS POLSKA Sp. z o.o.
Dąbrowa · Ulica Piaskowa 19 · 62-070 Dopiewo · Poland
Tel +48 61 654 09 00 · Fax +48 61 654 09 05
POL@rems.de



Spain: REMS ESPAÑA, S.A.U.
Pol. Ind. San José de Valderas
Calle Herramientas, 28 · 28918 Leganés (Madrid) · Spain
Tel +34 916 444 833 · Fax +34 916 430 155
ESP@rems.de



Czech Republic: REMS Česká republika s.r.o.
Nádražní 271 · 253 01 Hostivice · Czech Republic
Tel +420 2 20 98 28 80 · Fax +420 2 20 98 28 83
CZE@rems.de

Sale through specialist dealers.

